



catálogo



UBICACIÓN

Situada en Aretxabaleta. Dentro de la comarca guipuzcoana del Alto Deba. Un núcleo industrial referente con una destacada experiencia en innovación de producto y perfectamente comunicada con el resto de la península y Europa.



La concentración en un mismo espacio físico de oficinas comerciales, técnicas, producción y almacenamiento se traduce en mayor coordinación, eficacia y rapidez de respuesta.

experiencia y futuro

Más de 75 años en el mundo de la cerrajería nos proporcionan un control del medio, de las redes de distribución y de las necesidades del cliente. Pero sobre todo nos ha permitido entender que era el momento de dar un paso hacia adelante.



ÍNDICE POR REFERENCIA

REF.	PÁG.	REF.	PÁG.	REF.	PÁG.	REF.	PÁG.
3001	156	11A/3P	81	156A70D/1	90	192V25/6AN	35
13718000	163	11B	83	156A70I/0	90	192V30/6	35
13718000	164	11B/M	83	156A70I/1	90	192V30/6AN	35
14150000	163	11E	82	156B60D/0	91	192V35/6	35
14154000	163	122A70D/0	96	156B60D/1	91	192V35/6AN	35
1122A70D/0	96	122A70D/1	96	156B60I/0	91	194/25/6	36
1122A70D/1	96	122A70I/0	96	156B60I/1	91	194/25/6AN	36
1122A70I/0	96	122A70I/1	96	156BR70D/0	91	194/25/6U	36
1122A70I/1	96	122C70D/0	97	156BR70D/1	91	194/30/6	36
1122C70D/0	97	122C70D/1	97	156BR70I/0	91	194/30/6AN	36
1122C70D/1	97	122C70I/0	97	156BR70I/1	91	194/30/6U	36
1122C70I/0	97	122C70I/1	97	156C60D/0	92	194/35/6	36
1122C70I/1	97	123A10D/0	98	156C60D/1	92	194/35/6AN	36
1123A10D/0	98	123A10D/1	98	156C60I/0	92	194/35/6U	36
1123A10D/1	98	123A10I/0	98	156C60I/1	92	194V25/6	36
1123A10I/0	98	123A10I/1	98	156C70D/0	92	194V25/6AN	36
1123A10I/1	98	123A12D/0	98	156C70D/1	92	194V25/6U	36
1123A12D/0	98	123A12D/1	98	156C70I/0	92	194V30/6	36
1123A12D/1	98	123A12I/0	98	156C70I/1	92	194V30/6AN	36
1123A12I/0	98	123A12I/1	98	184/23/0	26	194V30/6U	36
1123A12I/1	98	123C10D/0	99	184/23/6	26	194V35/6	36
1123C10D/0	99	123C10D/1	99	184/25/0	26	194V35/6AN	36
1123C10D/1	99	123C10I/0	99	184/25/6	26	194V35/6U	36
1123C10I/0	99	123C10I/1	99	184/28/0	26	196/25/6	28
1123C10I/1	99	123C12D/0	99	184/28/6	26	196/25/6AN	28
1123C12D/0	99	123C12D/1	99	184/30/0	26	196/28/6	28
1123C12D/1	99	123C12I/0	99	184/30/6	26	196/28/6AN	28
1123C12I/0	99	123C12I/1	99	184/33/0	26	196/30/6	28
1123C12I/1	99	124A10D/0	95	184/33/6	26	196/30/6AN	28
1124A10D/0	95	124A10D/1	95	184/35/0	26	196/33/6	28
1124A10D/1	95	124A10I/0	95	184/35/6	26	196/33/6AN	28
1124A10I/0	95	124A10I/1	95	184A23/6	26	196/35/6	28
1124A10I/1	95	124A12D/0	95	184A25/6	26	196/35/6AN	28
1124A12D/0	95	124A12D/1	95	184A28/6	26	196/38/6	28
1124A12D/1	95	124A12I/0	95	184A30/6	26	196/38/6AN	28
1124A12I/0	95	124A12I/1	95	184A33/6	26	1960/60/2	111
1124A12I/1	95	124A14D/0	95	184A35/6	26	1960/60/6	111
1124A14D/0	95	124A14D/1	95	184C23/6	27	1960/70/2	111
1124A14D/1	95	124A14I/0	95	184C25/6	27	1960/70/6	111
1124A14I/0	95	124A14I/1	95	184C28/6	27	1960A60/2	111
1124A14I/1	95	124A8D/0	95	184C30/6	27	1960A60/6	111
1124A8D/0	95	124A8D/1	95	184C33/6	27	1960A70/2	111
1124A8D/1	95	124A8I/0	95	184C35/6	27	1960A70/6	111
1124A8I/0	95	124A8I/1	95	184V23/6	27	1960T60/2	111
1124A8I/1	95	125A12D/0	93	184V25/6	27	1960T60/6	111
1125A12D/0	93	125A12D/1	93	184V28/6	27	1960T70/2	111
1125A12D/1	93	125A12I/0	93	184V30/6	27	1960T70/6	111
1125A12I/0	93	125A12I/1	93	184V33/6	27	1961/60/2	112
1125A12I/1	93	125A14D/0	93	184V35/6	27	1961/70/2	112
1125A14D/0	93	125A14D/1	93	190/23/0	60	1961A60/2	112
1125A14D/1	93	125A14I/0	93	190/23/5	60	1961A70/2	112
1125A14I/0	93	125A14I/1	93	190/23/6	60	1962/60/2	113
1125A14I/1	93	125A8D/0	93	190/28/0	60	1962/70/2	113
1125A8D/0	93	125A8D/1	93	190/28/5	60	1962A60/2	113
1125A8D/1	93	125A8I/0	93	190/28/6	60	1962A70/2	113
1125A8I/0	93	125A8I/1	93	190/33/0	60	1962T60/2	113
1125A8I/1	93	125AR10D/0	93	190/33/5	60	1962T70/2	113
1125AR10D/0	93	125AR10D/1	93	190/33/6	60	1963/0	71
1125AR10D/1	93	125AR10I/0	93	190A23/0	60	1963/5	71
1125AR10I/0	93	125AR10I/1	93	190A23/5	60	1963/6	71
1125AR10I/1	93	125BR12D/0	94	190A23/6	60	1963A/0	71
1125BR12D/0	94	125BR12D/1	94	190A28/0	60	1963A/5	71
1125BR12D/1	94	125BR12I/0	94	190A28/5	60	1963A/6	71
1125BR12I/0	94	125BR12I/1	94	190A28/6	60	1963C/6	71
1125BR12I/1	94	125BR14D/0	94	190A33/0	60	1963CP16/6	72
1125BR14D/0	94	125BR14D/1	94	190A33/5	60	1963R/0	72
1125BR14D/1	94	125BR14I/0	94	190A33/6	60	1963RV/0	72
1125BR14I/0	94	125BR14I/1	94	192/25/6	35	1963V/0	72
1125BR14I/1	94	1404X000-Y	164	192/25/6AN	35	1963V/5	72
11981/60/0	76	156A60D/0	90	192/30/6	35	1963V/6	72
11981/60/5	76	156A60D/1	90	192/30/6AN	35	1964/0	74
11981V60/0	76	156A60I/0	90	192/35/6	35	1964/5	74
11981V60/5	76	156A60I/1	90	192/35/6AN	35	1964/6	74
11A	81	156A70D/0	90	192V25/6	35	1964A/0	74

ÍNDICE POR REFERENCIA

REF.	PÁG.	REF.	PÁG.	REF.	PÁG.	REF.	PÁG.
1964A/5	74	1970V50/6	110	1985T40/2	108	1995/32/5	58
1964C/0	74	1970V60/2	110	1985T40/6	108	1995/32/6	58
1964C/6	74	1970V60/6	110	1985T50/2	108	1995A32/6	58
1964CP/6	74	1975/0	73	1985T50/6	108	1995R32/0	58
1964R/0	75	1975/5	73	1985T60/2	108	1995T32/6	59
1964RV/0	75	1975A/0	73	1985T60/6	108	1995V32/6	59
1964T/0	75	1975A/5	73	1988/0	102	1E2/30/6	15
1964T/5	75	1975T/0	73	1988/1	102	1E2/30/6AN	15
1964T/6	75	1975T/5	73	198K25/6	53	1E2/30/6U	15
1964V/0	75	1975V/0	73	198K30/6	53	1E2/35/6	15
1964V/5	75	1975V/5	73	198K35/6	53	1E2/35/6AN	15
1964V/6	75	1976/1	100	198KB25/6	53	1E2/35/6U	15
1968/0	78	1978/0	101	198KB30/6	53	1E2/40/6	15
1968/5	78	1978/1	101	198KB35/6	53	1E2/40/6AN	15
196A25/6	28	1979/0	80	198KD20/6	53	1E2/40/6U	15
196A28/6	28	1979/5	80	1990/20/0	61	1E2/50/6	15
196A30/6	28	1979P/0	80	1990/20/5	61	1E2/50/6AN	15
196A33/6	28	1979P/5	80	1990/20/6	61	1E2/50/6U	15
196A35/6	28	1981/60/0	76	1990/25/0	61	1E5/30/6	17
196A38/6	28	1981/60/5	76	1990/25/5	61	1E5/30/6AN	17
196C25/6	29	1981V60/0	76	1990/25/6	61	1E5/30/6U	17
196C28/6	29	1981V60/5	76	1990/32/0	61	1E5/35/6	17
196C30/6	29	1982/0	79	1990/32/5	61	1E5/35/6AN	17
196C33/6	29	1982/5	79	1990/32/6	61	1E5/35/6U	17
196C35/6	29	1983/20/0	69	1990A20/0	61	1E5/40/6	17
196C38/6	29	1983/20/5	69	1990A20/5	61	1E5/40/6AN	17
196R23/6	29	1983/20/6	69	1990A20/6	61	1E5/40/6U	17
196R25/6	29	1983/25/0	69	1990A25/0	61	1E5/50/6	17
196R28/6	29	1983/25/5	69	1990A25/5	61	1E5/50/6AN	17
196R30/6	29	1983/25/6	69	1990A25/6	61	1E5/50/6U	17
196R33/6	29	1983/30/0	69	1990A32/0	61	1K2/30/6	20
196R35/6	29	1983/30/5	69	1990A32/5	61	1K2/33/6	20
196R38/6	29	1983/30/6	69	1990A32/6	61	1K2/35/6	20
196RV/6	30	1983A20/0	69	1990V20/0	61	1K2T30/6	20
196T23/6	29	1983A20/5	69	1990V20/5	61	1K2T33/6	20
196T25/6	29	1983A25/0	69	1990V20/6	61	1K2T35/6	20
196T28/6	29	1983A25/5	69	1990V25/0	61	1K5/30/6	18
196T30/6	29	1983A30/0	69	1990V25/5	61	1K5/33/6	18
196T33/6	29	1983A30/5	69	1990V25/6	61	1K5/35/6	18
196T35/6	29	1983C20/6	69	1990V32/0	61	1K5T30/6	18
196T38/6	29	1983C25/6	69	1990V32/5	61	1K5T33/6	18
196V25/6	30	1983C30/6	69	1990V32/6	61	1K5T35/6	18
196V28/6	30	1983R20/0	70	1991/60/0	77	234/50/1	103
196V30/6	30	1983R25/0	70	1991/60/5	77	234/60/1	103
196V33/6	30	1983R30/0	70	1991/70/0	77	234/70/1	103
196V35/6	30	1983RV/0	70	1991/70/5	77	236/50/1	104
196V38/6	30	1983T20/6	70	1992/20/6	68	236/60/1	104
197/25/6	31	1983T25/6	70	1992/25/6	68	236/70/1	104
197/28/6	31	1983T30/6	70	1992/30/6	68	249B50/2	115
197/30/6	31	1984/20/0	56	1992C20/6	68	249B60/2	115
197/33/6	31	1984/20/5	56	1992C25/6	68	249C50/2	115
197/35/6	31	1984/20/6	56	1992C30/6	68	249C60/2	115
197/38/6	31	1984/25/0	56	1992T20/6	68	249C70/2	115
1970/40/2	109	1984/25/5	56	1992T25/6	68	249R50/2	115
1970/40/6	109	1984/25/6	56	1992T30/6	68	249R60/2	115
1970/50/2	109	1984/30/0	56	1994/25/6	62	249R70/2	115
1970/50/6	109	1984/30/5	56	1994/25/6L	62	294/25/6L	37
1970/60/2	109	1984/30/6	56	1994/30/6	62	294/25/6LAN	37
1970/60/6	109	1984C20/6	56	1994/30/6L	62	294/25/6U	37
1970A40/2	109	1984C25/6	56	1994/35/6	62	294/30/6L	37
1970A40/6	109	1984C30/6	56	1994/35/6L	62	294/30/6LAN	37
1970A50/2	109	1984T20/6	57	1994A25/6	63	294/30/6U	37
1970A50/6	109	1984T25/6	57	1994A25/6L	63	294/35/6L	37
1970A60/2	109	1984T30/6	57	1994A30/6	63	294/35/6LAN	37
1970A60/6	109	1984V20/6	57	1994A30/6L	63	294/35/6U	37
1970T40/2	109	1984V25/6	57	1994A35/6	63	294V25/6L	38
1970T40/6	109	1984V30/6	57	1994A35/6L	63	294V25/6LAN	38
1970T50/2	109	1985/3P/2	108	1994V25/6	63	294V25/6U	38
1970T50/6	109	1985/40/2	108	1994V25/6L	63	294V30/6L	38
1970T60/2	109	1985/40/6	108	1994V30/6	63	294V30/6LAN	38
1970T60/6	109	1985/50/2	108	1994V30/6L	63	294V30/6U	38
1970V40/2	110	1985/50/6	108	1994V35/6	63	294V35/6L	38
1970V40/6	110	1985/60/2	108	1994V35/6L	63	294V35/6LAN	38
1970V50/2	110	1985/60/6	108	1995/32/0	58	294V35/6U	38

ÍNDICE POR REFERENCIA

REF.	PÁG.	REF.	PÁG.	REF.	PÁG.	REF.	PÁG.
296/25/6L	32	2E2/50/6LAN	14	3994F35/6	67	56A70D/0	90
296/25/6LAN	32	2E2/50/6U	14	3994F35/6L	67	56A70D/1	90
296/25/6U	32	2E2GB30/6L	13	3994V25/6	67	56A70I/0	90
296/28/6L	32	2E2GB30/6LAN	13	3994V25/6L	67	56A70I/1	90
296/28/6LAN	32	2E2GB30/6U	13	3994V30/6	67	56B60D/0	91
296/30/6L	32	2E2GB35/6L	13	3994V30/6L	67	56B60D/1	91
296/30/6LAN	32	2E2GB35/6LAN	13	3994V35/6	67	56B60I/0	91
296/30/6U	32	2E2GB35/6U	13	3994V35/6L	67	56B60I/1	91
296/33/6L	32	2E2GB40/6L	13	3I2/30/6L	25	56BR70D/0	91
296/33/6LAN	32	2E2GB40/6LAN	13	3I2/33/6L	25	56BR70D/1	91
296/35/6L	32	2E2GB40/6U	13	3I2/35/6L	25	56BR70I/0	91
296/35/6LAN	32	2E2GB50/6L	13	400/50/6HP	150	56BR70I/1	91
296/35/6U	32	2E2GB50/6LAN	13	400/60/6HP	150	56C60D/0	92
296/38/6L	32	2E2GB50/6U	13	4000/50/0	106	56C60D/1	92
296/38/6LAN	32	2E5/30/6L	16	4000/60/0	106	56C60I/0	92
296A25/6L	33	2E5/30/6LAN	16	4000A50/0	106	56C60I/1	92
296A25/6LAN	33	2E5/30/6U	16	4000A60/0	106	56C70D/0	92
296A25/6U	33	2E5/35/6L	16	4001/50/0	106	56C70D/1	92
296A28/6L	33	2E5/35/6LAN	16	4001/60/0	106	56C70I/0	92
296A28/6LAN	33	2E5/35/6U	16	4001A50/0	106	56C70I/1	92
296A30/6L	33	2E5/40/6L	16	4001A60/0	106	582PM2525/3	122
296A30/6LAN	33	2E5/40/6LAN	16	400L60/6HP	150	582PM2525/4	122
296A30/6U	33	2E5/40/6U	16	400LT60/6H	151	582PM2530/3	122
296A33/6L	33	2E5/50/6L	16	400T50/6H	151	582PM2530/4	122
296A33/6LAN	33	2E5/50/6LAN	16	400T60/6H	151	582PM2535/3	122
296A35/6L	33	2E5/50/6U	16	401/50/6HP	150	582PM2535/4	122
296A35/6LAN	33	2I2/30/6L	24	401/60/6HP	150	582PM2540/3	122
296A35/6U	33	2I2/30/6LAN	24	401L60/6HP	150	582PM2540/4	122
296A38/6L	33	2I2/30/6U	24	401LT60/6H	151	582PM2545/3	122
296A38/6LAN	33	2I2/33/6L	24	401T50/6H	151	582PM2545/4	122
296V25/6L	33	2I2/33/6LAN	24	401T60/6H	151	582PM2550/3	122
296V25/6LAN	33	2I2/33/6U	24	410/50/6HP	154	582PM2550/4	122
296V25/6U	33	2I2/35/6L	24	410/50D/6HP	153	582PM2555/3	122
296V28/6L	33	2I2/35/6LAN	24	410/50I/6HP	153	582PM2555/4	122
296V28/6LAN	33	2I2/35/6U	24	410/60/6HP	154	582PM2560/3	122
296V30/6L	33	2I2GB30/6L	23	410/60D/6HP	153	582PM2560/4	122
296V30/6LAN	33	2I2GB30/6LAN	23	410/60I/6HP	153	582PM2565/3	122
296V30/6U	33	2I2GB30/6U	23	4100/50/0	107	582PM2565/4	122
296V33/6L	33	2I2GB33/6L	23	4100/60/0	107	582PM25T25/3	123
296V33/6LAN	33	2I2GB33/6LAN	23	410L60/6HP	153	582PM25T25/4	123
296V35/6L	33	2I2GB33/6U	23	410L60D/6HP	152	582PM3030/3	122
296V35/6LAN	33	2I2GB35/6L	23	410L60I/6HP	152	582PM3030/4	122
296V35/6U	33	2I2GB35/6LAN	23	411/50/6HP	154	582PM3045/3	122
296V38/6L	33	2I2GB35/6U	23	411/50D/6HP	153	582PM3045/4	122
296V38/6LAN	33	2I5KD25/6U16	51	411/50I/6HP	153	582PM30T30/3	123
297K25/6U16	52	2I5KD25/6U22	51	411/60/6HP	154	582PM30T30/4	123
2994/25/6	64	2K2/30/6L	21	411/60D/6HP	153	582PM30T45/3	123
2994/25/6L	64	2K2/33/6L	21	411/60I/6HP	153	582PM30T45/4	123
2994/30/6	64	2K2/35/6L	21	411L60/6HP	153	582PM3525/3	122
2994/30/6L	64	2K5/30/6L	19	411L60D/6HP	152	582PM3525/4	122
2994/35/6	64	2K5/33/6L	19	411L60I/6HP	152	582PM3535/3	122
2994/35/6L	64	2K5/35/6L	19	4E24G30/6L	12	582PM3535/4	122
2994A25/6	65	3000AD	155	4E24G35/6L	12	582PM3540/3	122
2994A25/6L	65	3000AI	155	4E24G40/6L	12	582PM3540/4	122
2994A30/6	65	3005/6	155	4E24G50/6L	12	582PM3545/3	122
2994A30/6L	65	396/25/6L	34	4I24G30/6L	22	582PM3545/4	122
2994A35/6	65	396/30/6L	34	4I24G33/6L	22	582PM35T25/3	123
2994A35/6L	65	396/35/6L	34	4I24G35/6L	22	582PM35T25/4	123
2994V25/6	65	3994/25/6	66	4I54KD256U16	50	582PM35T35/3	123
2994V25/6L	65	3994/25/6L	66	4I54KD256U22	50	582PM35T35/4	123
2994V30/6	65	3994/30/6	66	5000/1N	143	590PM2525/3	126
2994V30/6L	65	3994/30/6L	66	5000/1NM	143	590PM2525/4	126
2994V35/6	65	3994/35/6	66	5000/6	143	590PM2530/3	126
2994V35/6L	65	3994/35/6L	66	5081/3030/3	135	590PM2530/4	126
2E2/30/6L	14	3994A25/6	66	5081/3030/4	135	590PM2535/3	126
2E2/30/6LAN	14	3994A25/6L	66	5181/3030/3	135	590PM2535/4	126
2E2/30/6U	14	3994A30/6	66	5181/3030/4	135	590PM2540/3	126
2E2/35/6L	14	3994A30/6L	66	5500/1N	144	590PM2540/4	126
2E2/35/6LAN	14	3994A35/6	66	5500/1NM	144	590PM2545/3	126
2E2/35/6U	14	3994A35/6L	66	5500/6	144	590PM2545/4	126
2E2/40/6L	14	3994F25/6	67	56A60D/0	90	590PM2550/3	126
2E2/40/6LAN	14	3994F25/6L	67	56A60D/1	90	590PM2550/4	126
2E2/40/6U	14	3994F30/6	67	56A60I/0	90	590PM2555/3	126
2E2/50/6L	14	3994F30/6L	67	56A60I/1	90	590PM2555/4	126

ÍNDICE POR REFERENCIA

REF.	PÁG.	REF.	PÁG.	REF.	PÁG.	REF.	PÁG.
590PM2560/3	126	5968T40/4	139	5982/4555/4	121	5990/3080/4	125
590PM2560/4	126	5979/3030/3	140	5982/5050/3	121	5990/3535/3	124
590PM2565/3	126	5979/3030/4	140	5982/5050/4	121	5990/3535/4	124
590PM2565/4	126	5979P3030/3	140	5982/5555/3	121	5990/3540/3	124
590PM25T25/3	127	5979P3030/4	140	5982/5555/4	121	5990/3540/4	124
590PM25T25/4	127	5982/2525/3	120	5982/6060/3	121	5990/3545/3	124
590PM3030/3	126	5982/2525/4	120	5982/6060/4	121	5990/3545/4	124
590PM3030/4	126	5982/2530/3	120	5982/6565/3	121	5990/3555/3	125
590PM3045/3	126	5982/2530/4	120	5982/6565/4	121	5990/3555/4	125
590PM3045/4	126	5982/2535/3	120	5982/7070/3	121	5990/3565/3	125
590PM30T30/3	127	5982/2535/4	120	5982/7070/4	121	5990/3565/4	125
590PM30T30/4	127	5982/2540/3	120	5982/7575/3	121	5990/3575/3	125
590PM30T45/3	127	5982/2540/4	120	5982/7575/4	121	5990/3575/4	125
590PM30T45/4	127	5982/2545/3	120	5982PT2505/3	122	5990/3595/3	125
590PM3525/3	126	5982/2545/4	120	5982PT2505/4	122	5990/3595/4	125
590PM3525/4	126	5982/2550/3	120	5982PT2525/3	123	5990/4040/3	124
590PM3535/3	126	5982/2550/4	120	5982PT2525/4	123	5990/4040/4	124
590PM3535/4	126	5982/2555/3	120	5982PT2535/3	123	5990/4050/3	125
590PM3540/3	126	5982/2555/4	120	5982PT2535/4	123	5990/4050/4	125
590PM3540/4	126	5982/2560/3	120	5982PT2545/3	123	5990/4055/3	125
590PM3545/3	126	5982/2560/4	120	5982PT2545/4	123	5990/4055/4	125
590PM3545/4	126	5982/2565/3	120	5982T40/3	122	5990/4060/3	125
590PM35T25/3	127	5982/2565/4	120	5982T40/4	122	5990/4060/4	125
590PM35T25/4	127	5982/2575/3	121	5982T45/3	122	5990/4070/3	125
590PM35T35/3	127	5982/2575/4	121	5982T45/4	122	5990/4070/4	125
590PM35T35/4	127	5982/2585/3	121	5982T50/3	122	5990/4080/3	125
5961/2525/3	136	5982/2585/4	121	5982T50/4	122	5990/4080/4	125
5961/2525/4	136	5982/2595/3	121	5982T55/3	122	5990/4545/3	125
5961/3030/3	136	5982/2595/4	121	5982T55/4	122	5990/4545/4	125
5961/3030/4	136	5982/3030/3	120	5982T60/3	122	5990/4555/3	125
5962/2525/3	137	5982/3030/4	120	5982T60/4	122	5990/4555/4	125
5962/3030/3	137	5982/3035/3	120	5982T65/3	122	5990/5050/3	125
5962/4040/3	137	5982/3035/4	120	5982T65/4	122	5990/5050/4	125
5962T30/3	137	5982/3040/3	120	5982T70/3	122	5990/5555/3	125
5962T40/3	137	5982/3040/4	120	5982T70/4	122	5990/5555/4	125
5963/2222/3	134	5982/3045/3	120	5990/2525/3	124	5990/6060/3	125
5963/2222/4	134	5982/3045/4	120	5990/2525/4	124	5990/6060/4	125
5963/2525/3	134	5982/3050/3	120	5990/2530/3	124	5990/6565/3	125
5963/2525/4	134	5982/3050/4	120	5990/2530/4	124	5990/6565/4	125
5963/3030/3	134	5982/3055/3	120	5990/2535/3	124	5990/7070/3	125
5963/3030/4	134	5982/3055/4	120	5990/2535/4	124	5990/7070/4	125
5963/3535/3	134	5982/3060/3	120	5990/2540/3	124	5990/7575/3	125
5963/3535/4	134	5982/3060/4	120	5990/2540/4	124	5990/7575/4	125
5963/4040/3	134	5982/3080/3	121	5990/2545/3	124	5990PT2505/3	126
5963/4040/4	134	5982/3080/4	121	5990/2545/4	124	5990PT2505/4	126
5963T36/3	134	5982/3535/3	120	5990/2550/3	124	5990PT2525/3	127
5963T36/4	134	5982/3535/4	120	5990/2550/4	124	5990PT2525/4	127
5964/2525/3	138	5982/3540/3	120	5990/2555/3	124	5990PT2535/3	127
5964/2525/4	138	5982/3540/4	120	5990/2555/4	124	5990PT2535/4	127
5964/3030/3	138	5982/3545/3	120	5990/2560/3	124	5990PT2545/3	127
5964/3030/4	138	5982/3545/4	120	5990/2560/4	124	5990PT2545/4	127
5964/4040/3	138	5982/3555/3	120	5990/2565/3	124	5990T40/3	126
5964/4040/4	138	5982/3555/4	120	5990/2565/4	124	5990T40/4	126
5964P3030/3	138	5982/3565/3	121	5990/2575/3	125	5990T45/3	126
5964P3030/4	138	5982/3565/4	121	5990/2575/4	125	5990T45/4	126
5964T25/3	138	5982/3575/3	121	5990/2585/3	125	5990T50/3	126
5964T25/4	138	5982/3575/4	121	5990/2585/4	125	5990T50/4	126
5964T30/3	138	5982/3595/3	121	5990/2595/3	125	5990T55/3	126
5964T30/4	138	5982/3595/4	121	5990/2595/4	125	5990T55/4	126
5964T40/3	138	5982/4040/3	120	5990/3030/3	124	5990T60/3	126
5964T40/4	138	5982/4040/4	120	5990/3030/4	124	5990T60/4	126
5968/2525/3	139	5982/4050/3	121	5990/3035/3	124	5990T65/3	126
5968/2525/4	139	5982/4050/4	121	5990/3035/4	124	5990T65/4	126
5968/3030/3	139	5982/4055/3	121	5990/3040/3	124	5990T70/3	126
5968/3030/4	139	5982/4055/4	121	5990/3040/4	124	5990T70/4	126
5968/4040/3	139	5982/4060/3	121	5990/3045/3	124	6000D/1N	145
5968/4040/4	139	5982/4060/4	121	5990/3045/4	124	6000D/1NM	145
5968P3030/3	139	5982/4070/3	121	5990/3050/3	124	6000D/6	145
5968P3030/4	139	5982/4070/4	121	5990/3050/4	124	6000I/1N	145
5968T25/3	139	5982/4080/3	121	5990/3055/3	124	6000I/1NM	145
5968T25/4	139	5982/4080/4	121	5990/3055/4	124	6000I/6	145
5968T30/3	139	5982/4545/3	121	5990/3060/3	125	612/25/6	148
5968T30/4	139	5982/4545/4	121	5990/3060/4	125	612/30/6	148
5968T40/3	139	5982/4555/3	121	5990/3080/3	125	612/35/6	148

ÍNDICE POR REFERENCIA

REF.	PÁG.	REF.	PÁG.	REF.	PÁG.	REF.	PÁG.
612E/25/6	149	6982/2550/4	128	6990/2535/4	131	6990T70/4	133
612E/30/6	149	6982/2555/3	128	6990/2540/3	131	943/2C	114
612E/35/6	149	6982/2555/4	128	6990/2540/4	131	943/2R	114
612P25/6	148	6982/2560/3	128	6990/2545/3	131	943/7C	114
612P30/6	148	6982/2560/4	128	6990/2545/4	131	943/7R	114
612P35/6	148	6982/2565/3	129	6990/2550/3	131	943P/2C	114
615/25/6	146	6982/2565/4	129	6990/2550/4	131	943P/2R	114
615/30/6	146	6982/2575/3	129	6990/2555/3	131	943P/7C	114
615/35/6	146	6982/2575/4	129	6990/2555/4	131	943P/7R	114
615E/25/6	147	6982/2585/3	129	6990/2560/3	131	B5000	160
615E/30/6	147	6982/2585/4	129	6990/2560/4	131	B5000/4	160
615E/35/6	147	6982/2595/3	129	6990/2565/3	132	BAR5000/1R	160
615P25/6	146	6982/2595/4	129	6990/2565/4	132	BAR5000/1RE	160
615P30/6	146	6982/3030/3	128	6990/2575/3	132	BAR5000/6	160
615P35/6	146	6982/3030/4	128	6990/2575/4	132	BAR5000/6E	160
682PM2525/3	130	6982/3035/3	128	6990/2585/3	132	BT1296/1N	48
682PM2525/4	130	6982/3035/4	128	6990/2585/4	132	BT194/1N	48
682PM2535/3	130	6982/3040/3	128	6990/2595/3	132	BT194/1N	88
682PM2535/4	130	6982/3040/4	128	6990/2595/4	132	CE184/OL	39
682PM2545/3	130	6982/3045/3	128	6990/3030/3	131	CE184/OLAN	39
682PM2545/4	130	6982/3045/4	128	6990/3030/4	131	CE184/1N	39
682PM2555/3	130	6982/3050/3	128	6990/3035/3	131	CE184/1NR	39
682PM2555/4	130	6982/3050/4	128	6990/3035/4	131	CE184/1NRS	39
682PM3030/3	130	6982/3055/3	128	6990/3040/3	131	CE184/6L	39
682PM3030/4	130	6982/3055/4	128	6990/3040/4	131	CE184/6LAN	39
682PM3525/3	130	6982/3060/3	129	6990/3045/3	131	CE184/6U	39
682PM3525/4	130	6982/3060/4	129	6990/3045/4	131	CE184A/OL	39
682PM3535/3	130	6982/3535/3	128	6990/3050/3	131	CE184A/6L	39
682PM3535/4	130	6982/3535/4	128	6990/3050/4	131	CE190/0	84
682PM3545/3	130	6982/3540/3	128	6990/3055/3	131	CE190/6	84
682PM3545/4	130	6982/3540/4	128	6990/3055/4	131	CE196/1N	40
682PM3555/3	130	6982/3545/3	128	6990/3060/3	132	CE196/1NR	41
682PM3555/4	130	6982/3545/4	128	6990/3060/4	132	CE196/1NRS	41
682PM3565/3	130	6982/3555/3	129	6990/3535/3	131	CE196/6L	40
682PM3565/4	130	6982/3555/4	129	6990/3535/4	131	CE196/6LAN	40
690PM2525/3	133	6982/3565/3	129	6990/3540/3	131	CE196/6LR	40
690PM2525/4	133	6982/3565/4	129	6990/3540/4	131	CE196/6RU	40
690PM2535/3	133	6982/4040/3	128	6990/3545/3	131	CE196/6U	40
690PM2535/4	133	6982/4040/4	128	6990/3545/4	131	CE1960/2	117
690PM2545/3	133	6982/4045/3	128	6990/3555/3	132	CE1960/6	117
690PM2545/4	133	6982/4045/4	128	6990/3555/4	132	CE1960A/2	117
690PM2555/3	133	6982/4050/3	129	6990/3565/3	132	CE1960A/6	117
690PM2555/4	133	6982/4050/4	129	6990/3565/4	132	CE196R/6	86
690PM3030/3	133	6982/4055/3	129	6990/4040/3	131	CE196R/6L	42
690PM3030/4	133	6982/4055/4	129	6990/4040/4	131	CE196R/6LAN	42
690PM3525/3	133	6982/4545/3	129	6990/4045/3	131	CE196R/6LR	42
690PM3525/4	133	6982/4545/4	129	6990/4045/4	131	CE1970A/2	117
690PM3535/3	133	6982/4555/3	129	6990/4050/3	132	CE1970A/6	117
690PM3535/4	133	6982/4555/4	129	6990/4050/4	132	CE1970R/2	117
690PM3545/3	133	6982/4560/3	129	6990/4055/3	132	CE1970R/6	117
690PM3545/4	133	6982/4560/4	129	6990/4055/4	132	CE1983/0	84
690PM3555/3	133	6982/5050/3	129	6990/4545/3	132	CE1983/6	84
690PM3555/4	133	6982/5050/4	129	6990/4545/4	132	CE1984/0	84
690PM3565/3	133	6982/5555/3	129	6990/4555/3	132	CE1984/6	84
690PM3565/4	133	6982/5555/4	129	6990/4555/4	132	CE1985/2	116
6964/3030/3	138	6982/6565/3	129	6990/4560/3	132	CE1985/6	116
6964/3030/4	138	6982/6565/4	129	6990/4560/4	132	CE1990/0	85
6964T30/3	138	6982/7070/3	129	6990/5050/3	132	CE1991/0	85
6964T30/4	138	6982/7070/4	129	6990/5050/4	132	CE1994/6	85
6968/3030/3	139	6982/7575/3	129	6990/5555/3	132	CE202GB/1NR	44
6968/3030/4	139	6982/7575/4	129	6990/5555/4	132	CE202GB/1NRS	44
6968T30/3	139	6982T40/3	130	6990/6565/3	132	CE202GB/6L	44
6968T30/4	139	6982T40/4	130	6990/6565/4	132	CE202GB/6LAN	45
6982/2525/3	128	6982T50/3	130	6990/7070/3	132	CE202GB/6LR18	45
6982/2525/4	128	6982T50/4	130	6990/7070/4	132	CE202GB/6LR20	45
6982/2530/3	128	6982T60/3	130	6990/7575/3	132	CE202S/1NR	44
6982/2530/4	128	6982T60/4	130	6990/7575/4	132	CE202S/1NRS	44
6982/2535/3	128	6982T70/3	130	6990T40/3	133	CE202S/6L	44
6982/2535/4	128	6982T70/4	130	6990T40/4	133	CE202S/6LAN	44
6982/2540/3	128	6990/2525/3	131	6990T50/3	133	CE202S/6LR18	45
6982/2540/4	128	6990/2525/4	131	6990T50/4	133	CE202S/6LR20	45
6982/2545/3	128	6990/2530/3	131	6990T60/3	133	CE202S/6U	45
6982/2545/4	128	6990/2530/4	131	6990T60/4	133	CE249R/2	117
6982/2550/3	128	6990/2535/3	131	6990T70/3	133	CE249R/6	117

ÍNDICE POR REFERENCIA

REF.	PÁG.	REF.	PÁG.	REF.	PÁG.	REF.	PÁG.
CE296S/1NR	42	CM5006d85/6R	158	KCE1K5/6LR	43	P2E2/50/6	14
CE296S/1NRS	42	CM5006i55/6R	158	KES4000	118	P2E2GB30/6	13
CE296S/6L	41	CM5006i72/6R	158	KES4100	118	P2E2GB35/6	13
CE296S/6LAN	41	CM5006i85/6R	158	M5000/1N	159	P2E2GB40/6	13
CE296S/6LR	41	CM5007D6R	158	M5001/1N	159	P2E2GB50/6	13
CE296S/6RU	42	CM5007i6R	158	M5002/1N	159	P2E5/30/6	16
CE296S/6U	41	CONNECT01	49	M5003/1N	159	P2E5/35/6	16
CE2994S/6	86	CV1E5	49	M5004/1N	159	P2E5/40/6	16
CE3I2PCICE	49	EMB196	49	P192/25/6	35	P2E5/50/6	16
CE4000/2	116	ES1960	118	P192/30/6	35	P2I2/30/6	24
CE4000/6	116	ES1960/4	118	P192/35/6	35	P2I2/33/6	24
CE4001/2	116	ES1962	118	P192V25/6	35	P2I2/35/6	24
CE4001/6	116	ES1962/4	118	P192V30/6	35	P2I2GB30/6	23
CE5000/1N	160	ES1963	88	P192V35/6	35	P2I2GB33/6	23
CE5000/6	160	ES1964	88	P198K25/6	53	P2I2GB35/6	23
CE942C30/2	118	ES1964	118	P198K30/6	53	PCF3I2ICE	49
CE942C35/2	118	ES1984	48	P198K35/6	53	PCI3I2CE	49
CE942R25/2	117	ES1984	88	P198KB25/6	53	POLCE-CVL	49
CE942R30/2	117	ES1985/0	118	P198KB30/6	53	TAP1E5	49
CE942R30/7	117	ES1985/1D	118	P198KB35/6	53	TUF6000/1N	160
CE942R35/2	117	ES1985/2	118	P198KD20/6	53	TUF6000/1NE	160
CE942R35/7	117	ES1985/7	118	P1E2/30/6	15	TUF6000/6	160
CEB6000	160	ID1/60/6R	162	P1E2/35/6	15	TUF6000/6E	160
CEB6000/1N	160	JES6000/6R	47	P1E2/40/6	15	VENM1	157
CEC41/6AD	46	JM2I5KD/1NR	54	P1E2/50/6	15	VENM2	157
CEC41T/6AD	46	JM6006/85/6R	47	P1E5/30/6	17	VENM3	157
CELC45/6A	87	JMB2I5KD/1NR	54	P1E5/35/6	17	VENM554	157
CELC45/6AD	87	JMB6000/6R	47	P1E5/40/6	17		
CELC45T/6A	87	JT6006/85/6R	47	P1E5/50/6	17		
CELC45T/6AD	87	KCE1K5/1NR	43	P2E2/30/6	14		
CM5006D55/6R	158	KCE1K5/1NRS	43	P2E2/35/6	14		
CM5006D72/6R	158	KCE1K5/6L	43	P2E2/40/6	14		



ABREVIATURAS DE ACABADOS CERRADURAS Y CILINDROS

COD.	FRENTE	CILINDRO
/0	Hierro Niquelado (HN)	Latón Niquelado (CN)
/1	Hierro Esmaltado (HE)	Latón Pulido (LP)
/2	Hierro Latonado (HL)	Latón Pulido (LP)
/3		Latón Pulido (LP)
/4		Latón Niquelado (CN)
/5	Hierro Niquelado (HN)	Latón Pulido (LP)
/6	Acero Inoxidable (AI)	Latón Niquelado (CN)
/7	Níquel Satinado (NS)	Latón Niquelado (CN)
/8	Zincado Trivalente (Z)	Latón Niquelado (CN)

ABREVIATURAS DE ACABADOS DE ANTIPÁNICOS Y ESCUDOS

COD.	ACABADO
/0	Niquelado
/1AB	Pintado bronce antiguo
/1D	Pintado dorado
/1N	Pintado negro
/1NM	Pintado níquel mate
/1PL	Pintado plata
/2	Latonado
/7	Níquel mate

CERRADURAS PARA CARPINTERÍA DE ALUMINIO

Certificado de Ensayo 10

PUERTAS BATIENTES

Multipunto palanca deslizante entre ejes 92 mm	12
• Serie 4E24 Soft	12
• Serie 2E2GB Soft	13
Multipunto palanca deslizante entre ejes 92 mm	14
• Serie 2E2 Soft	14
Palanca deslizante entre ejes 92 mm.....	15
• Serie 1E2 Soft	15
Multipunto palanca deslizante entre ejes 85 mm	16
• Serie 2E5 Soft	16
Palanca deslizante entre ejes 85 mm.....	17
• Serie 1E5 Soft	17
Palanca basculante entre ejes 85 mm.....	18
• Serie 1K5 DUE	18
Multipunto palanca basculante entre ejes 85 mm	19
• Serie 2K5 DUE	19
Palanca basculante entre ejes 92 mm.....	20
• Serie 1K2 DUE	20
Multipunto palanca basculante entre ejes 92 mm	21
• Serie 2K2 DUE	21
Multipunto palanca deslizante entre ejes 92 mm	22
• Serie 4I24 inverse	22
• Serie 2I2GB inverse	23
• Serie 2I2 inverse	24
• Serie 3I2 inverse	25
Palanca deslizante entre ejes 85 mm.....	26
• Serie 184	26
Palanca basculante entre ejes 85 mm.....	28
• Serie 196	28
Palanca gancho entre ejes 85 mm	31
• Serie 197	31
Multipunto palanca basculante entre ejes 85 mm	32
• Serie 296	32
Multipunto palanca basculante entre ejes 85 mm	34
• Serie 396	34
Palanca deslizante entre ejes 92 mm.....	35
• Serie 192	35
• Serie 194	36
Multipunto palanca basculante entre ejes 92 mm	37
• Serie 294	37
Accesorios.....	39
• Cerraderos	39
• Cerraderos eléctricos.....	46
• Escudos y manillas de acero inoxidable	47
• Escudos.....	48
• Otros	49

PUERTAS CORREDERAS

Multipunto palanca gancho entre ejes 85 mm	50
• Serie 4I54KD	50
• Serie 2I5KD	51
• Serie 297K	52
• Serie 198K	53
Accesorios.....	54
• Manillas.....	54

Certificado de Ensayos

EMPRESA	SISTEMAS VALLE LENIZ, S.A.
DIRECCIÓN	Pol.Ind.Arbi-Zelai s/n 20550 ARETXABALETA (GIPUZKOA)
Nº CERTIFICADO	18146 (1/2)

MATERIAL ENSAYADO

Cerradura de embutir con palanca deslizante de referencia:

«192/35/6»

- Entrada: 35
- Distancia entre ejes: 92

ENSAYOS REALIZADOS

Ensayos mecánicos establecidos en la norma UNE-EN 12209:2004
 «Herrajes en la edificación. Cerraduras, pestillos y cerraderos mecánicos.
 Requisitos y métodos de ensayo»

CLASIFICACIÓN

1	C	5	0	0	C	1	B	A	2	0
---	---	---	---	---	---	---	---	---	---	---

FECHA 18 de julio de 2008

Este documento no tiene validez sin el informe de ensayo correspondiente en el cual se indican los resultados obtenidos en cada ensayo.

Los resultados obtenidos en estos ensayos solo se refieren a la(s) muestra(s) analizada(s) en este Centro en la fecha indicada y no implican una característica de constancia en la calidad de la producción

Fdo: 
 Asier Maiztegi
 Director Dpto. Construcción

EMPRESA SISTEMAS VALLE LENIZ, S.A.

DIRECCIÓN Pol. Ind. Arbi-Zelai s/n
 20550 ARETXABAleta (GIPUZKOA) SPAIN

NºCERTIFICADO 18146 (2/2)

ÁREA DE APLICACIÓN

La cerradura de embutir con palanca deslizante de referencia “**192/35/6**” es la combinación más desfavorable de la serie **184-192**, que consiste en varias referencias que siguen el siguiente esquema:

192 xyy/z
184 xyy/z

donde:

192: Distancia entre ejes	▪ 92 mm	
184: Distancia entre ejes	▪ 85 mm	
x: tipo de cerradura	▪ /: picaporte y palanca	
	▪ A: palanca	
	▪ C: muletilla	
yy: entrada	▪ 23	▪ 30
	▪ 25	▪ 33
	▪ 28	▪ 35
Z: material	▪ 0: hierro niquelado	
	▪ 6: acero inoxidable	

Por lo tanto, se deduce que la clasificación obtenida por la referencia **192/35/6** y mostrada en la página anterior puede aplicarse a todas las referencias pertenecientes a esta serie.

FECHA 18 de julio de 2008

Este documento no tiene validez sin el informe de ensayo correspondiente en el cual se indican los resultados obtenidos en cada ensayo.

Los resultados obtenidos en estos ensayos solo se refieren a la(s) muestra(s) analizada(s) en este Centro en la fecha indicada y no implican una característica de constancia en la calidad de la producción

 Asier Maiztegi
 Director Dpto. Construcción

MULTIPUNTO PALANCA DESLIZANTE ENTRE EJES 92 mm

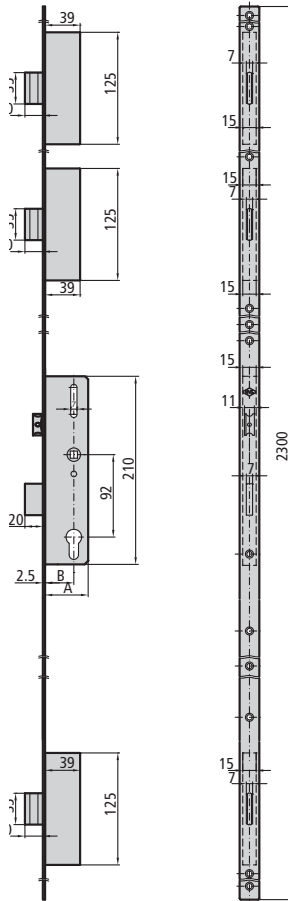
SERIE 4E24 **Soft**

CARACTERÍSTICAS

- Máxima suavidad entre engranajes
- Cerradura de 4 puntos con frente liso inox de 22 mm
- Frente de 2300 mm de largo
- Picaporte reversible y regulable de 11 mm
- Punto alto y bajo con gancho
- Mínimo stock: 3 versiones en 1 cerradura (picaporte/rodillo/sólo palanca)
- Palanca deslizante
- Diseño según norma EN12209 y pr. EN 15685
- Caja cerrada de 15 mm
- Cuadradillo de 8 mm
- Tornillo de fijación de cilindro

ACCESORIOS OPCIONALES

- Gama completa de cerraderos (ver páginas 39 - 45)
- Gama completa de cilindros (ver página 119 - 140)

DESCRIPCIÓN

REF.

MEDIDAS

LEVA

ACABADOS

UDS

B A

FRENTE CILINDRO

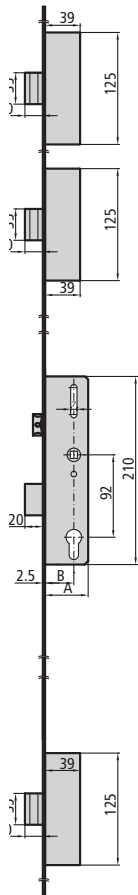

- Picaporte y palanca
- Cilindro no incluido

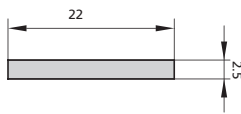
Opciones de cerradero
(ver páginas 39 - 45)

4E24G30/6L	27	43	15	Al	1
4E24G35/6L	32	48	15	Al	1
4E24G40/6L	37	53	15	Al	1
4E24G50/6L	47	63	15	Al	1

MULTIPUNTO PALANCA DESLIZANTE ENTRE EJES 92 mm

SERIE 2E2GB Soft

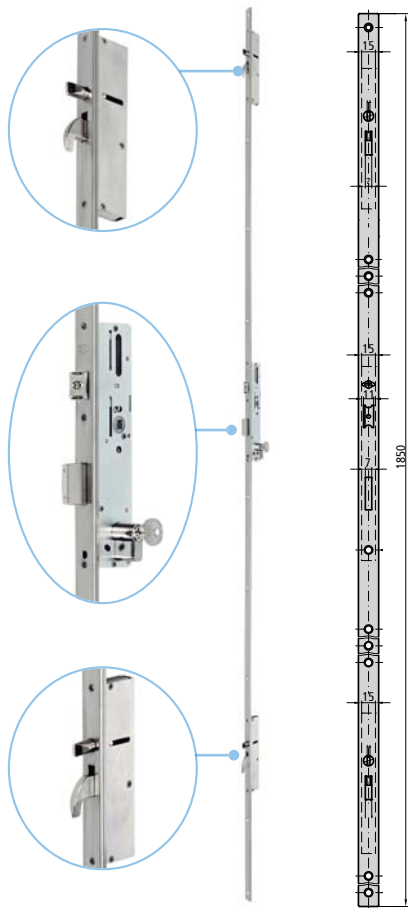

CARACTERÍSTICAS

- Máxima suavidad entre engranajes
- Cerradura multipunto con frente liso inox de 16 mm, 22 mm, 24 mm y U 24,5*6
- Frente de 1850 mm de largo
- Picaporte reversible y regulable de 11 mm
- Punto alto y bajo con gancho y bullón
- Mínimo stock: 3 versiones en 1 cerradura (picaporte/rodillo/sólo palanca)
- Palanca deslizante
- Diseño según norma EN12209 y pr. EN 15685
- Caja cerrada de 15 mm
- Cuadradillo de 8 mm
- Tornillo de fijación de cilindro

ACCESORIOS OPCIONALES

- Gama completa de cerraderos (ver páginas 39 - 45)
- Gama completa de cilindros (ver página 119 - 140)
- Frente de 2300 mm de largo opcional (serie 4E2GB)
- Frente de 1500 mm de largo opcional (serie 5E2GB)

DESCRIPCIÓN	REF.	MEDIDAS		LEVA	ACABADOS		UDS	
		B	A		FRENTE	CILINDRO		

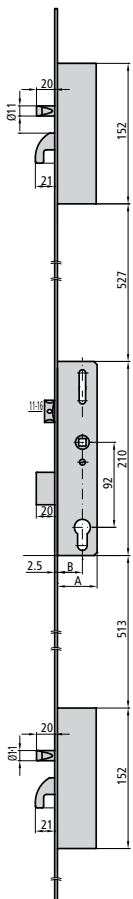

- Picaporte y palanca
- Cilindro no incluido

Opciones de cerradero
(ver páginas 39 - 45)

	P2E2GB30/6	27	43	15	AI		1
	P2E2GB35/6	32	48	15	AI		1
	P2E2GB40/6	37	53	15	AI		1
	P2E2GB50/6	47	63	15	AI		1
	2E2GB30/6L	27	43	15	AI		1
	2E2GB35/6L	32	48	15	AI		1
	2E2GB40/6L	37	53	15	AI		1
	2E2GB50/6L	47	63	15	AI		1
	2E2GB30/6LAN	27	43	15	AI		1
	2E2GB35/6LAN	32	48	15	AI		1
	2E2GB40/6LAN	37	53	15	AI		1
	2E2GB50/6LAN	47	63	15	AI		1
	2E2GB30/6U	23	39	15	AI		1
	2E2GB35/6U	28	44	15	AI		1
	2E2GB40/6U	33	49	15	AI		1
	2E2GB50/6U	43	59	15	AI		1

PUERTAS BATIENTES

MULTIPUNTO PALANCA DESLIZANTE ENTRE EJES 92 mm

SERIE 2E2 Soft

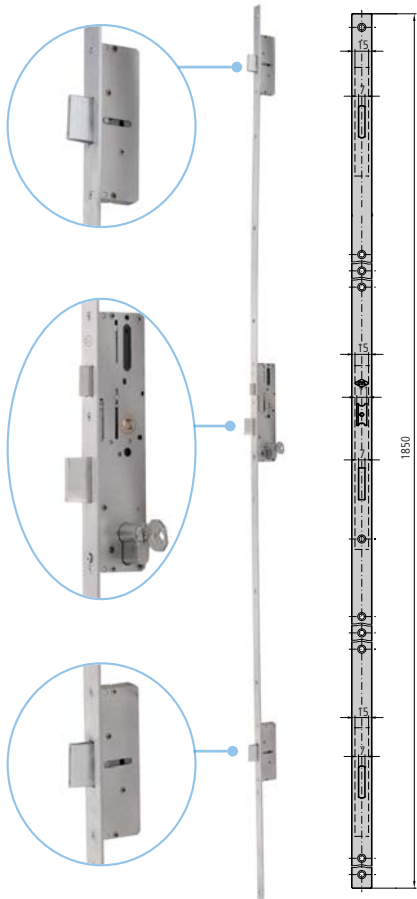

CARACTERÍSTICAS

- Máxima suavidad entre engranajes
- Cerradura de 3 puntos con frente liso inox de 16 mm, 22 mm, 24 mm y U 24,5*6
- Frente de 1850 mm de largo
- Picaporte reversible y regulable de 11 mm
- Mínimo stock: 3 versiones en 1 cerradura (picaporte/rodillo/sólo palanca)
- Palanca deslizante
- Diseño según norma EN12209 y pr. EN 15685
- Caja cerrada de 15 mm
- Cuadradillo de 8 mm
- Tornillo de fijación de cilindro

ACCESORIOS OPCIONALES

- Gama completa de cerraderos (ver páginas 39 - 45)
- Gama completa de cilindros (ver página 119 - 140)
- Frente de 2300 mm de largo opcional (serie 4E2)
- Frente de 1500 mm de largo opcional (serie 5E2)

DESCRIPCIÓN	REF.	MEDIDAS		LEVA	ACABADOS		UDS	
		B	A		FRENTE	CILINDRO		

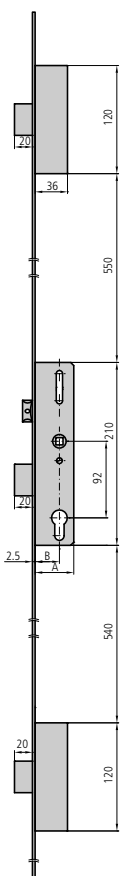

- Picaporte y palanca
- Cilindro no incluido

Opciones de cerradero
(ver páginas 39 - 45)

	P2E2/30/6	27	43	15	AI	1
	P2E2/35/6	32	48	15	AI	1
	P2E2/40/6	37	53	15	AI	1
	P2E2/50/6	47	63	15	AI	1
	2E2/30/6L	27	43	15	AI	1
	2E2/35/6L	32	48	15	AI	1
	2E2/40/6L	37	53	15	AI	1
	2E2/50/6L	47	63	15	AI	1
	2E2/30/6LAN	27	43	15	AI	1
	2E2/35/6LAN	32	48	15	AI	1
	2E2/40/6LAN	37	53	15	AI	1
	2E2/50/6LAN	47	63	15	AI	1
	2E2/30/6U	23	39	15	AI	1
	2E2/35/6U	28	44	15	AI	1
	2E2/40/6U	33	49	15	AI	1
	2E2/50/6U	43	59	15	AI	1

PALANCA DESLIZANTE ENTRE EJES 92 mm

SERIE 1E2 Soft

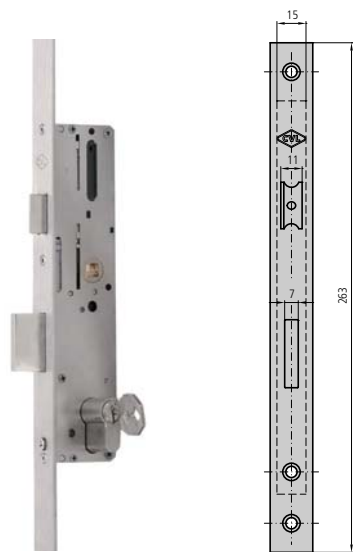

CARACTERÍSTICAS

- Máxima suavidad entre engranajes
- Frente liso inox de 16 mm, 22 mm, 24 mm y U 24,5*6
- Picaporte reversible y regulable de 11 mm
- Mínimo stock: 3 versiones en 1 cerradura (picaporte/rodillo/sólo palanca)
- Palanca deslizante
- Diseño según norma EN12209 y pr. EN 15685
- Caja cerrada de 15 mm
- Cuadradillo de 8 mm
- Tornillo de fijación de cilindro

ACCESORIOS OPCIONALES

- Gama completa de cerraderos (ver páginas 39 - 45)
- Gama completa de cilindros (ver página 119 - 140)

DESCRIPCIÓN	REF.	MEDIDAS		LEVA	ACABADOS		UDS	
		B	A		FRENTE	CILINDRO		

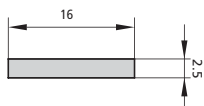

P1E2/30/6	27	43	15	Al		1
P1E2/35/6	32	48	15	Al		1
P1E2/40/6	37	53	15	Al		1
P1E2/50/6	47	63	15	Al		1

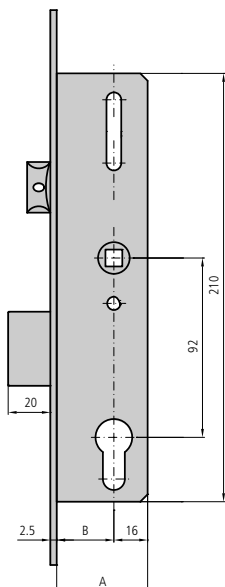

- Picaporte y palanca
- Cilindro no incluido

Opciones de cerradero
(ver páginas 39 - 45)

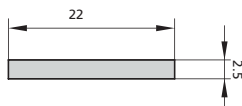

1E2/30/6	27	43	15	Al		1
1E2/35/6	32	48	15	Al		1
1E2/40/6	37	53	15	Al		1
1E2/50/6	47	63	15	Al		1

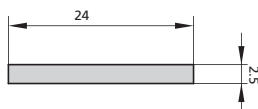

1E2/30/6AN	27	43	15	Al		1
1E2/35/6AN	32	48	15	Al		1
1E2/40/6AN	37	53	15	Al		1
1E2/50/6AN	47	63	15	Al		1

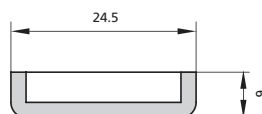

1E2/30/6U	23	39	15	Al		1
1E2/35/6U	28	44	15	Al		1
1E2/40/6U	33	49	15	Al		1
1E2/50/6U	43	59	15	Al		1

PUERTAS BATIENTES

MULTIPUNTO PALANCA DESLIZANTE ENTRE EJES 85 mm.

SERIE 2E5 *Soft*

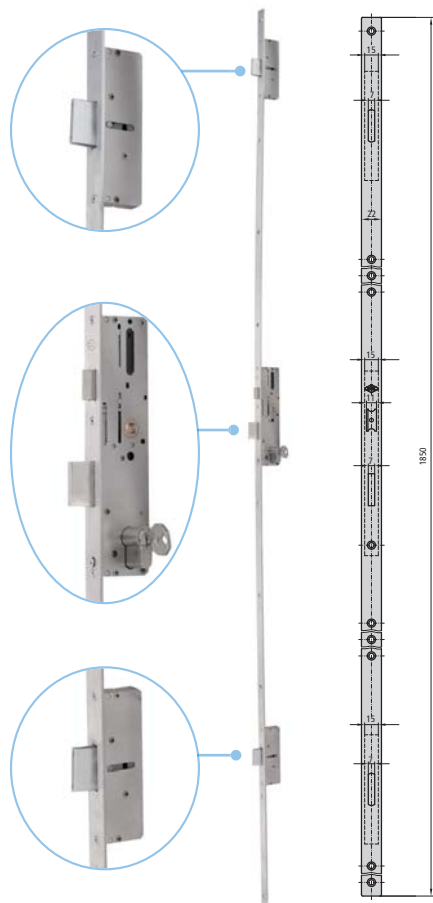

CARACTERÍSTICAS

- Máxima suavidad mediante engranajes
- Cerradura de 3 puntos con frente liso inox de 16 mm, 22 mm, 24 mm y U 24,5*6
- Frente de 1850 mm de largo
- Picaporte reversible y regulable de 11 mm
- Mínimo stock: 3 versiones en 1 cerradura (picaporte/rodillo/sólo palanca)
- Palanca deslizante
- Diseño según norma EN12209 y pr. EN 15685
- Caja cerrada de 15 mm
- Cuadradillo de 8 mm
- Tornillo de fijación de cilindro

ACCESORIOS OPCIONALES

- Gama completa de cerraderos (ver páginas 39 - 45)
- Gama completa de cilindros (ver página 119 - 140)
- Frente de 2300 mm de largo opcional (serie 4E5)
- Frente de 1500 mm de largo opcional (serie 5E5)

DESCRIPCIÓN	REF.	MEDIDAS		LEVA	ACABADOS		UDS	
		B	A		FRENTE	CILINDRO		

- Picaporte y palanca
- Cilindro no incluido

Opciones de cerradero
(ver páginas 39 - 45)

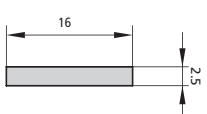
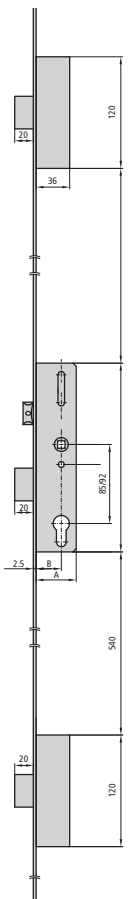

P2E5/30/6	27	43	15	AI	1
P2E5/35/6	32	48	15	AI	1
P2E5/40/6	37	53	15	AI	1
P2E5/50/6	47	63	15	AI	1

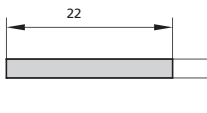

2E5/30/6L	27	43	15	AI	1
2E5/35/6L	32	48	15	AI	1
2E5/40/6L	37	53	15	AI	1
2E5/50/6L	47	63	15	AI	1

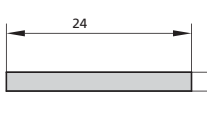

2E5/30/6LAN	27	43	15	AI	1
2E5/35/6LAN	32	48	15	AI	1
2E5/40/6LAN	37	53	15	AI	1
2E5/50/6LAN	47	63	15	AI	1

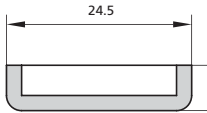

2E5/30/6U	23	39	15	AI	1
2E5/35/6U	28	44	15	AI	1
2E5/40/6U	33	49	15	AI	1
2E5/50/6U	43	59	15	AI	1

PALANCA DESLIZANTE ENTRE EJES 85 mm.

SERIE 1E5 Soft

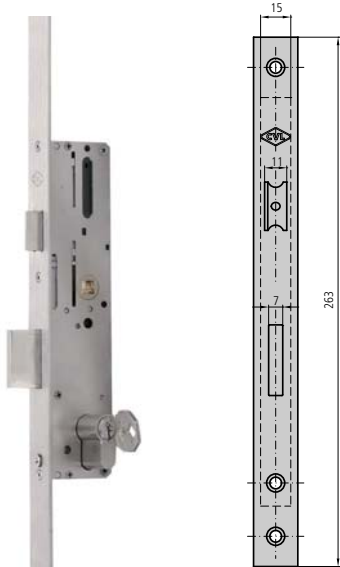

CARACTERÍSTICAS

- Máxima suavidad mediante engranajes
- Cerradura de 1 punto con frente liso inox de 16 mm, 22 mm, 24 mm y U 24,5*6
- Picaporte reversible y regulable de 11 mm
- Mínimo stock: 3 versiones en 1 cerradura (picaporte/rodillo/sólo palanca)
- Palanca deslizante
- Diseño según norma EN12209 y pr. EN 15685
- Caja cerrada de 15 mm
- Cuadradillo de 8 mm
- Tornillo de fijación de cilindro

ACCESORIOS OPCIONALES

- Gama completa de cerraderos (ver páginas 39 - 45)
- Gama completa de cilindros (ver página 119 - 140)

DESCRIPCIÓN	REF.	MEDIDAS		LEVA	ACABADOS		UDS	
		B	A		FRENTE	CILINDRO		

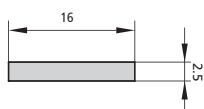

P1E5/30/6	27	43	15	Al		1	
P1E5/35/6	32	48	15	Al		1	
P1E5/40/6	37	53	15	Al		1	
P1E5/50/6	47	63	15	Al		1	

- Picaporte y palanca
- No incluye cilindro

Opciones de cerradero
(ver páginas 39 - 45)

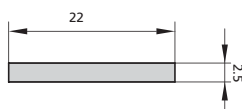
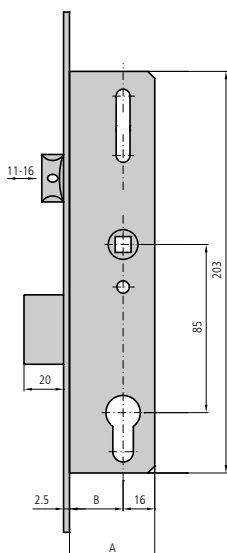

1E5/30/6	27	43	15	Al		1	
1E5/35/6	32	48	15	Al		1	
1E5/40/6	37	53	15	Al		1	
1E5/50/6	47	63	15	Al		1	

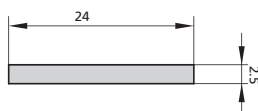

1E5/30/6AN	27	43	15	Al		1	
1E5/35/6AN	32	48	15	Al		1	
1E5/40/6AN	37	53	15	Al		1	
1E5/50/6AN	47	63	15	Al		1	

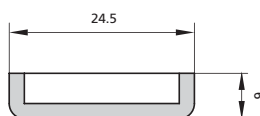

1E5/30/6U	23	39	15	Al		1	
1E5/35/6U	28	44	15	Al		1	
1E5/40/6U	33	49	15	Al		1	
1E5/50/6U	43	59	15	Al		1	



PALANCA BASCULANTE ENTRE EJES 85 mm.

SERIE 1K5 DUE

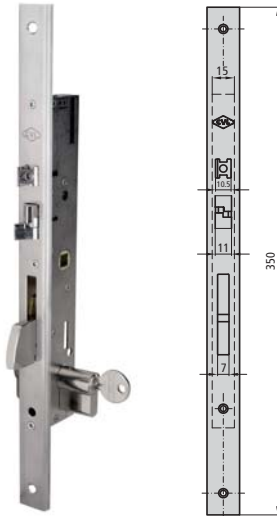

CARACTERÍSTICAS

- Cerradura eléctrica 12V con apertura eléctrica automática con manilla o con cilindro
- Cerradura de 1 punto con frente liso inox de 16 mm, 22 mm, 24 mm y U 24,5*6
- Sistema antitarjeta
- Compatible para CA y CC
- Mínimo esfuerzo para cierre de puerta
- Caja de 15 mm
- Cuadradillo de 8 mm
- 2 escudos de nylon ref. ES1984
- Cerraderos de serie según cerradura
- Tornillo de fijación de cilindro
- 2 terminales de frente de nylon ref. EMB196 para frente liso (para frente de 22 mm.)

ACCESORIOS OPCIONALES

- Gama completa de cerraderos (ver páginas 39 - 45)
- Gama completa de cilindros (ver página 119 - 140)
- Conectores (ver páginas 49) CONECT01

DESCRIPCIÓN

REF.

MEDIDAS

LEVA

ACABADOS

UDS

B

A

FRENTE

CILINDRO

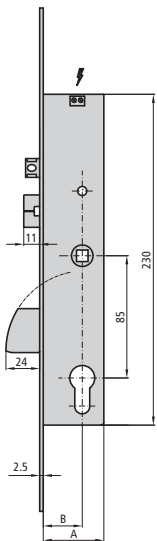

- Picaporte y palanca
- Cilindro no incluido
- Incluye cerradero Ref. KCE1K5/6L

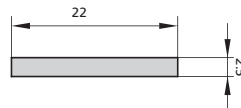

1K5/30/6	27	42	15	Al	1
1K5/33/6	30	43	13,25	Al	1
1K5/35/6	32	47	15	Al	1

* Otras medidas de frente consultar.

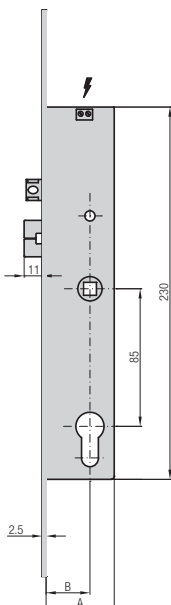

- Sólo picaporte
- Cilindro no incluido
- Incluye cerradero Ref. KCE1K5T/6L

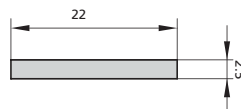

1K5T30/6	27	42	15	Al	1
1K5T33/6	30	43	13,25	Al	1
1K5T35/6	32	47	15	Al	1

* Otras medidas de frente consultar.



MULTIPUNTO PALANCA BASCULANTE ENTRE EJES 85 mm.

SERIE 2K5 DUE

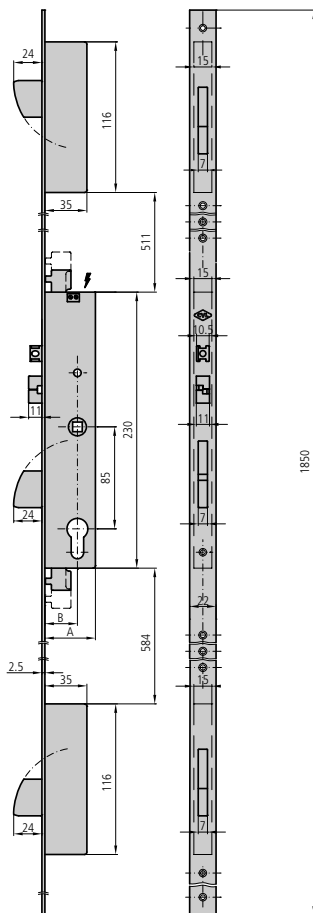

CARACTERÍSTICAS

- Cerradura eléctrica 12V con apertura eléctrica automática con manilla o con cilindro
- Cerradura de 3 puntos con frente liso inox de 16 mm, 22 mm, 24 mm y U 24,5*6
- Frente de 1850 mm de largo
- Sistema antitarjeta
- Compatible para CA y CC
- Mínimo esfuerzo para cierre de puerta
- Caja de 15 mm
- Cuadradillo de 8 mm
- Escudo de seguridad pasante ref. BT1196/1N
- Cerraderos de serie según cerradura
- Tornillo de fijación de cilindro

ACCESORIOS OPCIONALES

- Gama completa de cerraderos (ver páginas 39 - 45)
- Gama completa de cilindros (ver página 119 - 140)
- Frente de 2300 mm de largo opcional (serie 4K5)
- Frente de 1500 mm de largo opcional (serie 5K5)
- Conectores (ver páginas 49) CONECT01

DESCRIPCIÓN	REF.	MEDIDAS		LEVA	ACABADOS		UDS
		B	A		FRENTE	CILINDRO	

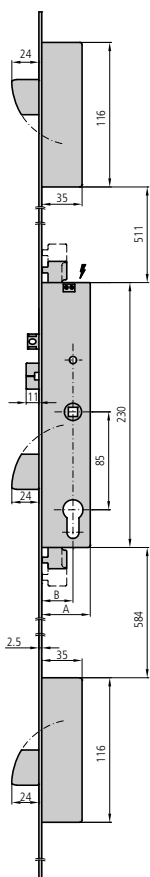

- Picaporte y palanca
- Cilindro no incluido
- Incluye cerradero ref. KCE1K5/6L
- 2 unidades alto/bajo: CE296S/6L

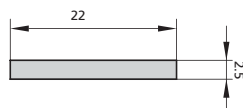

2K5/30/6L	27	42	15	Al	1
2K5/33/6L	30	43	13,25	Al	1
2K5/35/6L	32	47	15	Al	1

* Otras medidas de frente consultar.



PALANCA BASCULANTE ENTRE EJES 92 mm.

SERIE 1K2 DUE

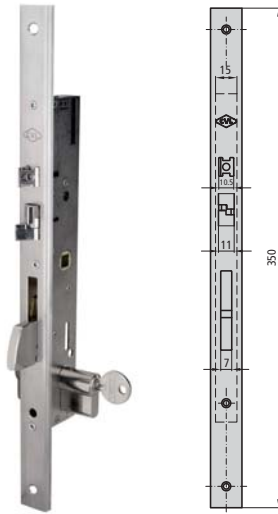

CARACTERÍSTICAS

- Cerradura eléctrica 12V con apertura eléctrica automática con manilla o con cilindro
- Cerradura de 1 punto con frente liso inox de 16 mm, 22 mm, 24 mm y U 24,5*6
- Sistema antitarjeta
- Compatible para CA y CC
- Mínimo esfuerzo para cierre de puerta
- Caja de 15 mm
- Cuadrado de 8 mm
- 2 escudos de nylon ES1984
- Cerraderos de serie según cerradura
- Tornillo de fijación de cilindro
- 2 terminales de frente de nylon ref. EMB196 para frente liso (para frente de 22 mm.)

ACCESORIOS OPCIONALES

- Gama completa de cerraderos (ver páginas 39 - 45)
- Gama completa de cilindros (ver página 119 - 140)
- Conectores (ver páginas 49) CONECT01

DESCRIPCIÓN

REF.

MEDIDAS

LEVA

ACABADOS

UDS

B

A

FRENTE

CILINDRO

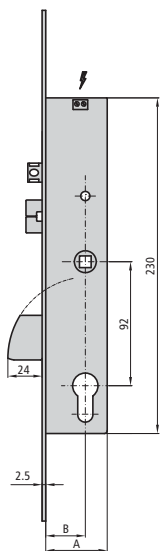

- Picaporte y palanca
- Cilindro no incluido
- Incluye cerradero ref. KCE1K2/6L

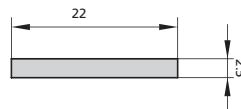

1K2/30/6	27	42	15	Al	1
1K2/33/6	30	43	13,25	Al	1
1K2/35/6	32	47	15	Al	1

* Otras medidas de frente consultar.

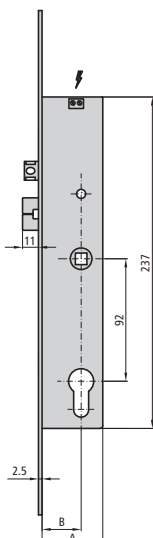

- Sólo picaporte
- Cilindro no incluido
- Incluye cerradero ref. KCE1K5T/6L

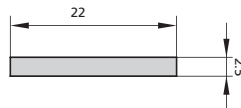

1K2T30/6	27	42	15	Al	1
1K2T33/6	30	43	13,25	Al	1
1K2T35/6	32	47	15	Al	1

* Otras medidas de frente consultar.



MULTIPUNTO PALANCA BASCULANTE ENTRE EJES 92 mm.

SERIE 2K2 DUE

CARACTERÍSTICAS

- Cerradura eléctrica 12V con apertura eléctrica automática con manilla o con cilindro
- Cerradura de 3 puntos con frente liso inox de 16 mm, 22 mm, 24 mm y U 24,5*6
- Frente de 1850 mm de largo
- Sistema antitarjeta
- Compatible con CA y CC
- Mínimo esfuerzo para cierre de puerta
- Caja de 15 mm
- Cuadrado de 8 mm
- Escudo de seguridad pasante ref. BT1196/1N
- Cerraderos de serie según cerradura
- Tornillo de fijación de cilindro

ACCESORIOS OPCIONALES

- Gama completa de cerraderos (ver páginas 39 - 45)
- Gama completa de cilindros (ver página 119 - 140)
- Frente de 2300 mm de largo opcional (serie 4K2)
- Frente de 1500 mm de largo opcional (serie 5K2)
- Conectores (ver páginas 49) CONECT01

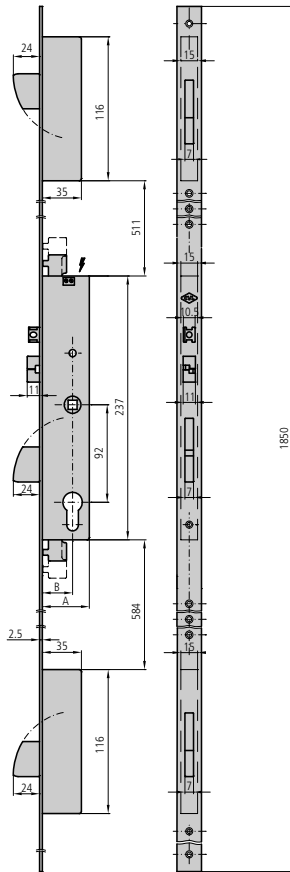

DESCRIPCIÓN

REF.

MEDIDAS
B A

LEVA

ACABADOS
FRENTE CILINDRO

UDS

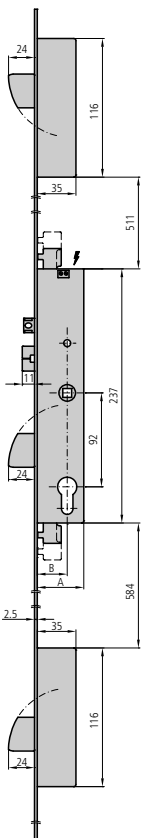

- Picaporte y palanca
- Cilindro no incluido
- Incluye cerradero central ref. KCE1K5/6L
- 2 unidades alto/bajo: CE296S/6L

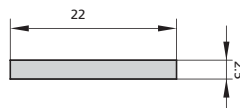

2K2/30/6L	27	42	15	Al	1
2K2/33/6L	30	43	13,25	Al	1
2K2/35/6L	32	47	15	Al	1

* Otras medidas de frente consultar.

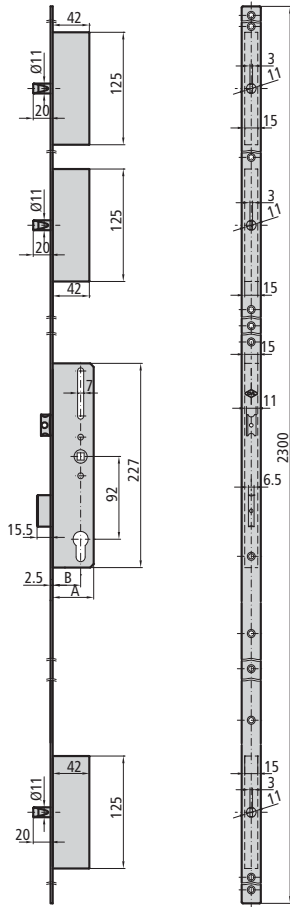
MULTIPUNTO PALANCA DESLIZANTE ENTRE EJES 92 mm.
SERIE 4I24 inve[®]se

CARACTERÍSTICAS

- Cerradura de 4 puntos con facilidad de cierre mediante manilla hacia arriba y bloqueo mediante llave
- Frente liso inox de 22 mm
- Frente de 2300 mm de largo
- Picaporte de 11 mm reversible y regulable
- Palanca central deslizante reforzada
- Puntos alto y bajo con gancho
- Caja cerrada de 15 mm
- Cuadradillo de 8 mm
- Tornillo de fijación de cilindro

ACCESORIOS OPCIONALES

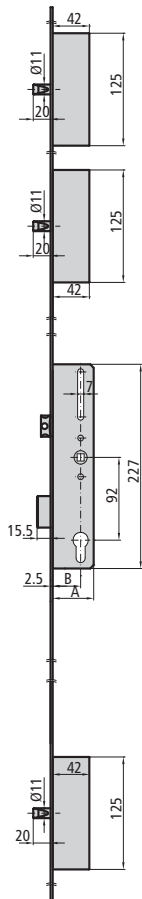
- Gama completa de cerraderos (ver páginas 39 - 45)
- Gama completa de cilindros (ver página 119 - 140)

DESCRIPCIÓN
REF.
MEDIDAS
LEVA
ACABADOS
UDS
B A
FRENTE CILINDRO

- Picaporte y palanca
- Cilindro no incluido

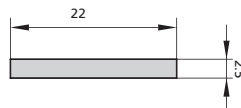
Opciones de cerradero
(ver páginas 39 - 45)

4I24G30/6L	27	42	15	Al	1
4I24G33/6L	30	45	15	Al	1
4I24G35/6L	32	47	15	Al	1

MULTIPUNTO PALANCA DESLIZANTE ENTRE EJES 92 mm.

SERIE 2I2GB *inve@se*

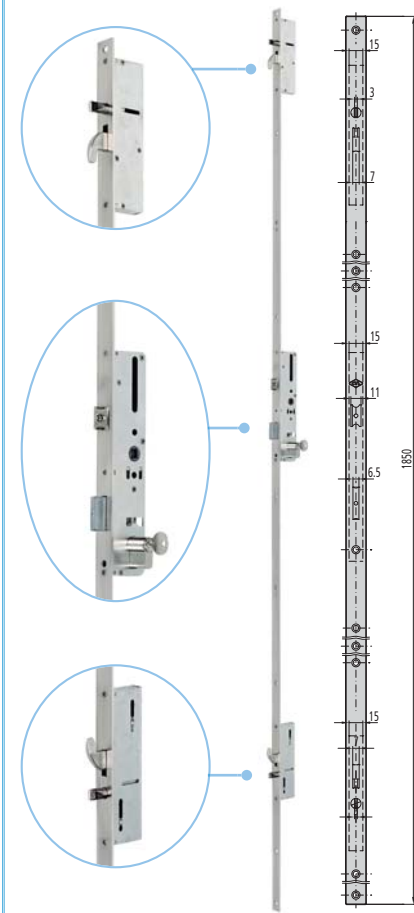

CARACTERÍSTICAS

- Cerradura multipunto con facilidad de cierre mediante manilla hacia arriba y bloqueo mediante llave
- Frente liso inox de 16 mm, 22 mm, 24 mm y U 24,5*6
- Frente de 1850 mm de largo
- Picaporte de 11 mm reversible y regulable
- Palanca central deslizante reforzada
- Punto alto y bajo con gancho y bulón
- Caja cerrada de 15 mm
- Cuadradillo de 8 mm
- Tornillo de fijación de cilindro

ACCESORIOS OPCIONALES

- Gama completa de cerraderos (ver páginas 39 - 45)
- Gama completa de cilindros (ver página 119 - 140)
- Frente de 2300 mm de largo opcional (serie 402)
- Frente de 1500 mm de largo opcional (serie 502)

DESCRIPCIÓN	REF.	MEDIDAS		LEVA	ACABADOS		UDS	
		B	A		FRENTE	CILINDRO		

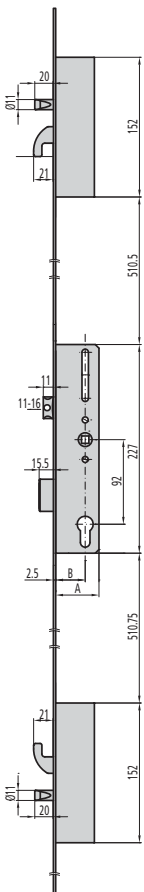

- Picaporte y palanca
- Cilindro no incluido

Opciones de cerradero
(ver páginas 39 - 45)

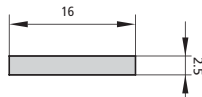

P2I2GB30/6	27	42	15	Al	1
P2I2GB33/6	30	45	15	Al	1
P2I2GB35/6	32	47	15	Al	1

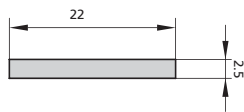

2I2GB30/6L	27	42	15	Al	1
2I2GB33/6L	30	45	15	Al	1
2I2GB35/6L	32	47	15	Al	1

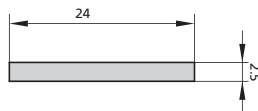

2I2GB30/6LAN	27	42	15	Al	1
2I2GB33/6LAN	30	45	15	Al	1
2I2GB35/6LAN	32	47	15	Al	1

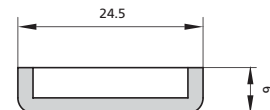

2I2GB30/6U	23	38	15	Al	1
2I2GB33/6U	26	41	15	Al	1
2I2GB35/6U	28	43	15	Al	1

PUERTAS BATIENTES

MULTIPUNTO PALANCA DESLIZANTE ENTRE EJES 92 mm.

SERIE 2I2 inve[®]se

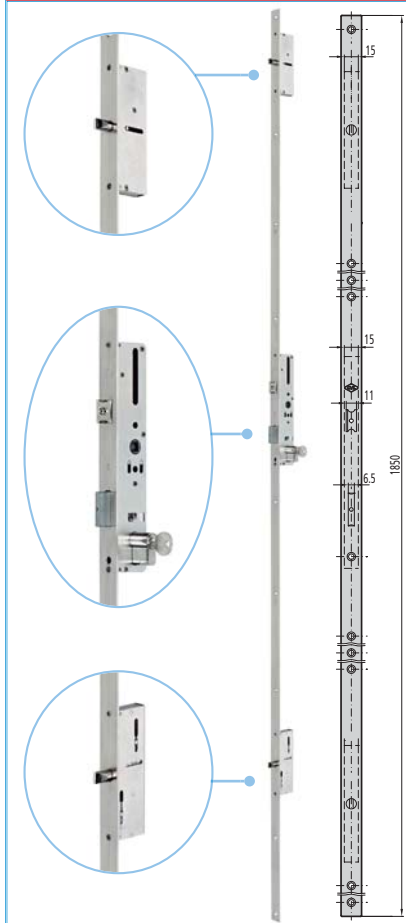

CARACTERÍSTICAS

- Cerradura de 3 puntos con facilidad de cierre mediante manilla hacia arriba y bloqueo mediante llave
- Frente liso inox de 16 mm, 22 mm, 24 mm y U 24,5*6
- Frente de 1850 mm de largo
- Picaorte de 11 mm reversible y regulable
- Palanca central deslizante reforzada
- Caja cerrada de 15 mm
- Cuadradillo de 8 mm
- Tornillo de fijación de cilindro

ACCESORIOS OPCIONALES

- Gama completa de cerraderos (ver páginas 39 - 45)
- Gama completa de cilindros (ver página 119 - 140)
- Frente de 2300 mm de largo opcional (serie 402)
- Frente de 1500 mm de largo opcional (serie 502)

DESCRIPCIÓN	REF.	MEDIDAS		LEVA	ACABADOS		UDS
		B	A		FRENTE	CILINDRO	

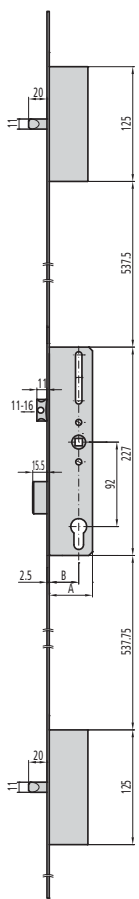

- Picaorte y palanca
- Cilindro no incluido

Opciones de cerradero
(ver páginas 39 - 45)

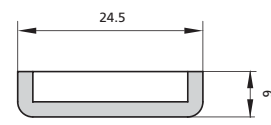
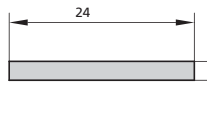
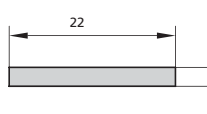
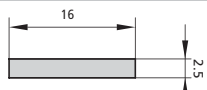

P2I2/30/6	27	42	15	Al	1
P2I2/33/6	30	45	15	Al	1
P2I2/35/6	32	47	15	Al	1
2I2/30/6L	27	42	15	Al	1
2I2/33/6L	30	45	15	Al	1
2I2/35/6L	32	47	15	Al	1
2I2/30/6LAN	27	42	15	Al	1
2I2/33/6LAN	30	45	15	Al	1
2I2/35/6LAN	32	47	15	Al	1
2I2/30/6U	23	38	15	Al	1
2I2/33/6U	26	41	15	Al	1
2I2/35/6U	28	43	15	Al	1

MULTIPUNTO PALANCA DESLIZANTE ENTRE EJES 92 mm.

SERIE 312 inve[®]se

CARACTERÍSTICAS

- Cerradura de 3 puntos central y alto/bajo con facilidad de cierre mediante manilla hacia arriba y bloqueo mediante llave
- Frente liso inox de 16 mm, 22 mm, 24 mm y U 24,5*6
- Frente de 350 mm de largo
- Picaporte de 11 mm reversible y regulable
- Palanca central deslizante reforzada
- Caja cerrada de 15 mm
- Cuadradillo de 8 mm
- 2 escudos de nylon ref. ES1984
- Tornillo de fijación de cilindro

ACCESORIOS OPCIONALES

- Gama completa de cerraderos (ver páginas 39 - 45)
- Gama completa de cilindros (ver página 119 - 140)
- Accesorios 312 (ver página 49)

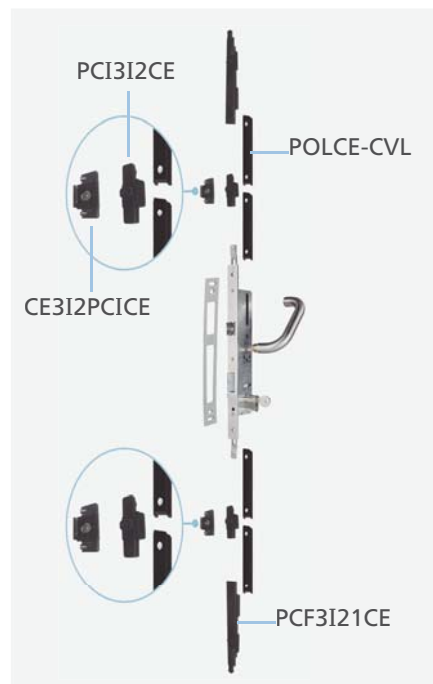
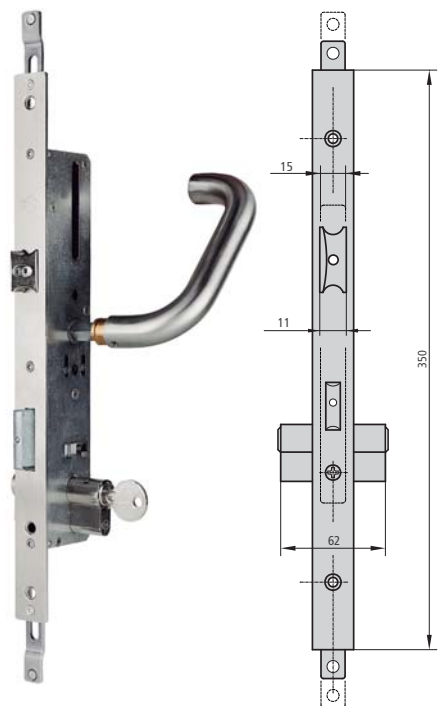

DESCRIPCIÓN

REF.

MEDIDAS

LEVA

ACABADOS

UDS

B A

FRENTE CILINDRO



- Picaporte y palanca
- Cilindro no incluido

Opciones de cerradero
(ver páginas 39 - 45)

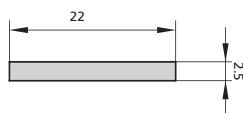

3I2/30/6L	27	42	15	Al	1	10
3I2/33/6L	30	45	15	Al	1	10
3I2/35/6L	32	47	15	Al	1	10

* Otras medidas de frente consultar.

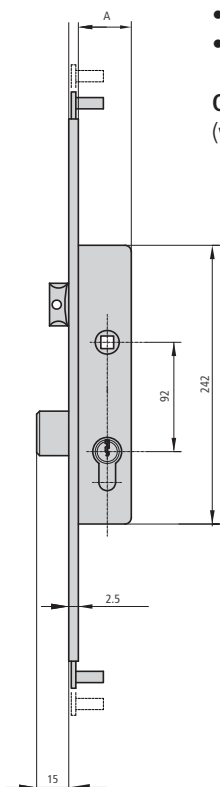

PUERTAS BATIENTES

PALANCA DESLIZANTE ENTRE EJES 85 mm.

SERIE 184

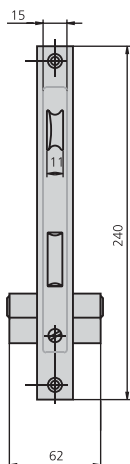

CARACTERÍSTICAS

- Frente de 22 mm ó 24 mm
- Picaporte reversible de 11 mm
- Caja de 15 mm
- Cuadradillo de 8 mm
- 2 escudos de nylon ref. E51984
- 2 terminales de frente de nylon ref. EMB196 (para frente de 22 mm)
- Tornillo de fijación de cilindro

ACCESORIOS OPCIONALES

- Gama completa de cerraderos (ver páginas 39 - 45)
- Gama completa de cilindros (ver página 119 - 140)

DESCRIPCIÓN	REF.	MEDIDAS		LEVA	ACABADOS		UDS	
		B	A		FRENTE	CILINDRO		

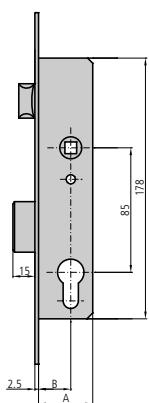

- Picaporte y palanca
- Cilindros de leva larga 5982/2525/4 o de leva corta 5990/2525/4

Opciones de cerradero
(ver páginas 39 - 45)

Opción cerraderos eléctricos
(ver página 46)

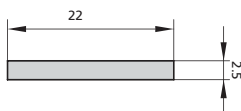

184/23/0	20	33	13,25	HN	CN	1	20
184/23/6	20	33	13,25	AI	CN	1	20
184/25/0	22	37	15	HN	CN	1	20
184/25/6	22	37	15	AI	CN	1	20
184/28/0	25	38	13,25	HN	CN	1	20
184/28/6	25	38	13,25	AI	CN	1	20
184/30/0	27	42	15	HN	CN	1	20
184/30/6	27	42	15	AI	CN	1	20
184/33/0	30	43	13,25	HN	CN	1	20
184/33/6	30	43	13,25	AI	CN	1	20
184/35/0	32	47	15	HN	CN	1	20
184/35/6	32	47	15	AI	CN	1	20

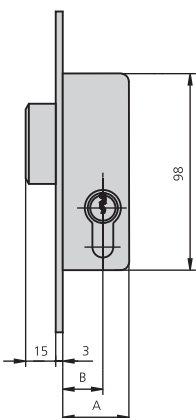

- Sólo palanca
- Cilindros de leva larga 5982/2525/4 o de leva corta 5990/2525/4

Opciones de cerradero
(ver páginas 39 - 45)

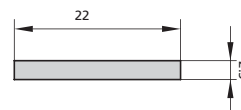

184A23/6	20	33	13,25	AI	CN	1	30
184A25/6	22	37	15	AI	CN	1	30
184A28/6	25	38	13,25	AI	CN	1	30
184A30/6	27	42	15	AI	CN	1	30
184A33/6	30	43	13,25	AI	CN	1	30
184A35/6	32	47	15	AI	CN	1	30

PALANCA DESLIZANTE ENTRE EJES 85 mm.

SERIE 184

DESCRIPCIÓN	REF.	MEDIDAS		LEVA	ACABADOS		UDS	
		B	A		FRENTE	CILINDRO		

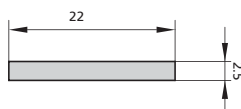
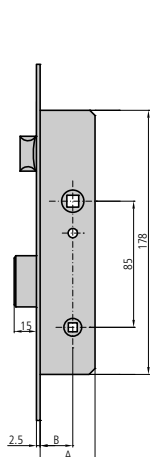

- Con condena

Opciones de cerradero
(ver páginas 39 - 45)

184C23/6	20	33		Al		2	40
184C25/6	22	37		Al		2	40
184C28/6	25	38		Al		2	40
184C30/6	27	42		Al		2	40
184C33/6	30	43		Al		2	40
184C35/6	32	47		Al		2	40

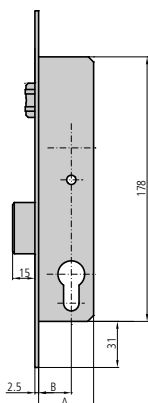
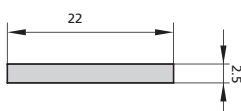

- Rodillo vaivén regulable y palanca
- Cilindros de leva larga 5982/2525/4 o de leva corta 5990/2525/4

Opciones de cerradero
(ver páginas 39 - 45)

184V23/6	20	33	13,25	Al	CN	1	20
184V25/6	22	37	15	Al	CN	1	20
184V28/6	25	38	13,25	Al	CN	1	20
184V30/6	27	42	15	Al	CN	1	20
184V33/6	30	43	13,25	Al	CN	1	20
184V35/6	32	47	15	Al	CN	1	20

PUERTAS BATIENTES

PALANCA BASCULANTE ENTRE EJES 85 mm.

SERIE 196

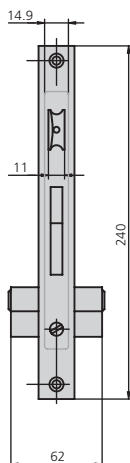

CARACTERÍSTICAS

- Frente inox de 22 mm o 24 mm o frente U de 24,5 x 6
- Picaporte reversible de 11 mm
- Picaporte regulable excepto en entrada 25 mm y 28 mm
- Caja de 15 mm
- Cuadradillo de 8 mm
- 2 escudos de nylon ref. ES1984
- 2 terminales de frente de nylon ref. EMB196 (para frente de 22 mm)
- Tornillo de fijación de cilindro

ACCESORIOS OPCIONALES

- Gama completa de cerraderos (ver páginas 39 - 45)
- Gama completa de cerraderos (ver página 119 - 140)
- Escudo de seguridad pasante BTI296/1N (ver página 48)

DESCRIPCIÓN	REF.	MEDIDAS		LEVA	ACABADOS		UDS	
		B	A		FRENTE	CILINDRO		

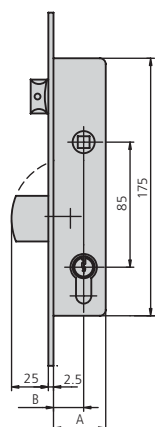

- Picaporte y palanca
- Cilindro de leva larga 5982/2525/4 o de leva corta 5990/2525/4

Opciones de cerradero
(ver páginas 39 - 45)

Opción cerradero eléctrico
(ver página 46)

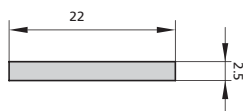

196/25/6	22	37	15	AI	CN	1	20
196/28/6	25	38	13,25	AI	CN	1	20
196/30/6	27	42	15	AI	CN	1	20
196/33/6	30	43	13,25	AI	CN	1	20
196/35/6	32	47	15	AI	CN	1	20
196/38/6	35	48	13,25	AI	CN	1	20

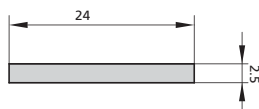

196/25/6AN	22	37	15	AI	CN	1	20
196/28/6AN	25	38	13,25	AI	CN	1	20
196/30/6AN	27	42	15	AI	CN	1	20
196/33/6AN	30	43	13,25	AI	CN	1	20
196/35/6AN	32	47	15	AI	CN	1	20
196/38/6AN	35	48	13,25	AI	CN	1	20

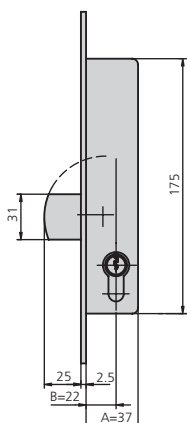

- Sólo palanca
- Cilindro de leva larga 5982/2525/4 o de leva corta 5990/2525/4

Opciones de cerradero
(ver páginas 39 - 45)

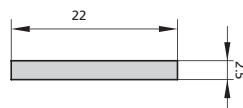

196A25/6	22	37	15	AI	CN	1	20
196A28/6	25	38	13,25	AI	CN	1	20
196A30/6	27	42	15	AI	CN	1	20
196A33/6	30	43	13,25	AI	CN	1	20
196A35/6	32	47	15	AI	CN	1	20
196A38/6	35	48	13,25	AI	CN	1	20

PALANCA BASCULANTE ENTRE EJES 85 mm. SERIE 196

DESCRIPCIÓN	REF.	MEDIDAS		LEVA	ACABADOS		UDS	
		B	A		FRENTE	CILINDRO		

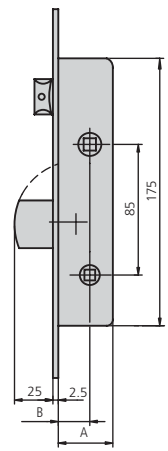

- Con condena y sin cilindro
- Opciones de cerradero**
(ver páginas 39 - 45)

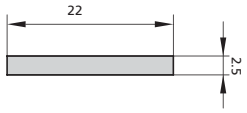

196C25/6	22	37		AI		2	40
196C28/6	25	38		AI		2	40
196C30/6	27	42		AI		2	40
196C33/6	30	43		AI		2	40
196C35/6	32	47		AI		2	40
196C38/6	35	48		AI		2	40

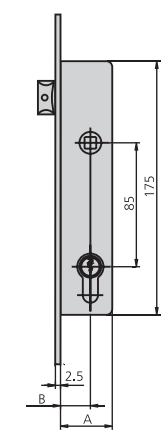

- Sólo picaporte y medio cilindro
 - Cilindro 5982T40/4
- Opción cerradero eléctrico**
(ver página 46)

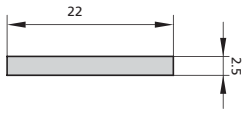

196T23/6	20	33	13,25	AI	CN	1	20
196T25/6	22	37	15	AI	CN	1	20
196T28/6	25	38	13,25	AI	CN	1	20
196T30/6	27	42	15	AI	CN	1	20
196T33/6	30	43	13,25	AI	CN	1	20
196T35/6	32	47	15	AI	CN	1	20
196T38/6	35	48	13,25	AI	CN	1	20

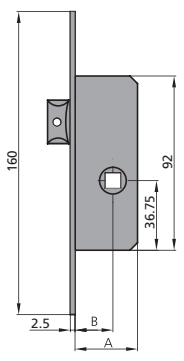

- Sólo picaporte y sin cilindro
- Opciones de cerradero**
(ver páginas 39 - 45)

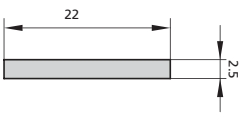

196R23/6	20	33		AI	CN	2	20
196R25/6	22	37		AI	CN	2	20
196R28/6	25	38		AI	CN	2	20
196R30/6	27	42		AI	CN	2	20
196R33/6	30	43		AI	CN	2	20
196R35/6	32	47		AI	CN	2	20
196R38/6	35	48		AI	CN	2,	20

PUERTAS BATIENTES

PALANCA BASCULANTE ENTRE EJES 85 mm.

SERIE 196

DESCRIPCIÓN	REF.	MEDIDAS		LEVA	ACABADOS		UDS	
		B	A		FRENTE	CILINDRO		

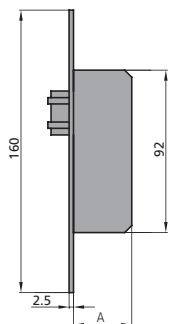

- Sólo vaivén

Opciones de cerradero
(ver páginas 39 - 45)

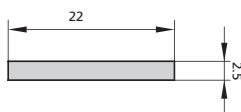

196RV/6		33		AI	CN	2	20
---------	--	----	--	----	----	---	----

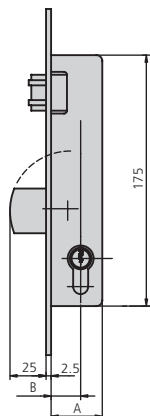

- Rodillo vaivén regulable y palanca
- Cilindro de leva larga 5982/2525/4 o de leva corta 5990/2525/4

Opciones de cerradero
(ver páginas 39 - 45)

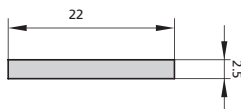

196V25/6	22	37	15	AI	CN	1	20
196V28/6	25	38	13,25	AI	CN	1	20
196V30/6	27	42	15	AI	CN	1	20
196V33/6	30	43	13,25	AI	CN	1	20
196V35/6	32	47	15	AI	CN	1	20
196V38/6	35	48	13,25	AI	CN	1	20

PALANCA GANCHO ENTRE EJES 85 mm.

SERIE 197

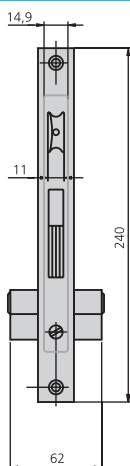

CARACTERÍSTICAS

- Frente inox de 22 mm
- Picaporte reversible de 11 mm
- Picaporte regulable excepto en entrada 25 mm y 28 mm
- Caja de 15 mm
- Cuadradillo de 8 mm
- 2 escudos de nylon ref. E51984
- 2 terminales de frente de nylon ref. EMB196 (para frente de 22 mm)
- Tornillo de fijación de cilindro

ACCESORIOS OPCIONALES

- Gama completa de cerraderos (ver páginas 39 - 45)
- Gama completa de cilindros (ver página 119 - 140)
- Escudo de seguridad pasante BT1296/1N (ver página 48)

DESCRIPCIÓN	REF.	MEDIDAS		LEVA	ACABADOS		UDS	
		B	A		FRENTE	CILINDRO		
<ul style="list-style-type: none"> • Picaporte y palanca gancho • Cilindro de leva larga 5982/2525/4 o de leva corta 5990/2525/4 <p>Opciones de cerradero (ver páginas 39 - 45)</p>	197/25/6	22	37	15	Al	CN	1	20
	197/28/6	25	38	13,25	Al	CN	1	20
	197/30/6	27	42	15	Al	CN	1	20
	197/33/6	30	43	13,25	Al	CN	1	20
	197/35/6	32	47	15	Al	CN	1	20
	197/38/6	35	48	13,25	Al	CN	1	20

PUERTAS BATIENTES

MULTIPUNTO PALANCA BASCULANTE ENTRE EJES 85 mm.

SERIE 296

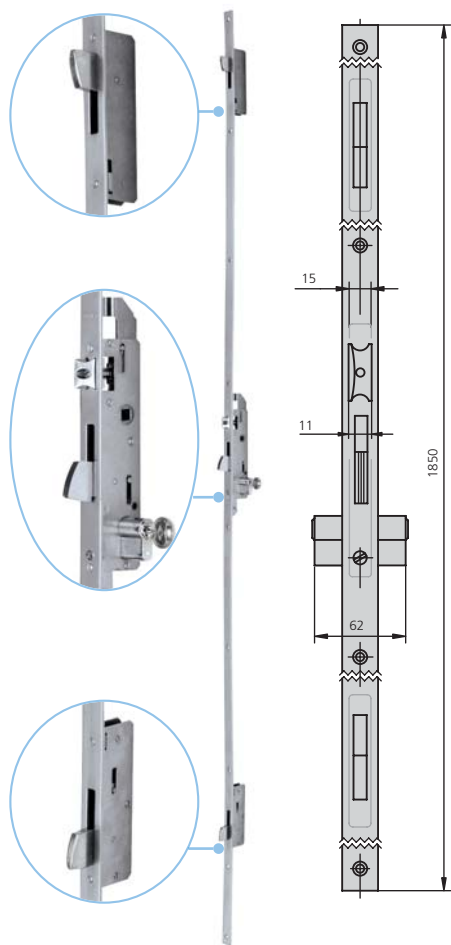

CARACTERÍSTICAS

- Frente liso inox de 1850x22 mm o 1850x24 mm o frente U 1850x24,5x6
- Picaporte reversible de 11 mm
- Picaporte regulable excepto en entrada 25 mm y 28 mm
- Caja de 15 mm
- Cuadradillo de 8 mm
- Tornillo de fijación de cilindro

ACCESORIOS OPCIONALES

- Gama completa de cerraderos (ver páginas 39 - 45)
- Gama completa de cilindros (ver página 119 - 140)
- Frente de 2300 mm de largo opcional (serie 496)
- Frente de 1500 mm de largo opcional (serie 596)

DESCRIPCIÓN	REF.	MEDIDAS		LEVA	ACABADOS		UDS	
		B	A		FRENTE	CILINDRO		

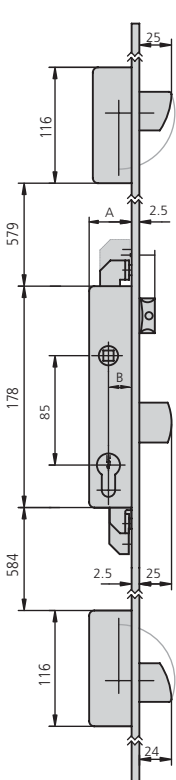

- Picaporte y palanca
- Cilindro no incluido

Opciones de cerradero
(ver páginas 39 - 45)

Opción cerradero eléctrico
(ver página 46)

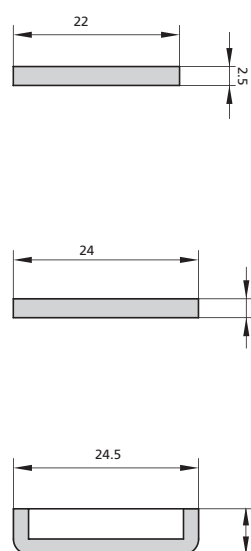

296/25/6L	22	37	15	Al	1
296/28/6L	25	38	13,25	Al	1
296/30/6L	27	42	15	Al	1
296/33/6L	30	43	13,25	Al	1
296/35/6L	32	47	15	Al	1
296/38/6L	35	48	13,25	Al	1
296/25/6LAN	22	37	15	Al	1
296/28/6LAN	25	38	13,25	Al	1
296/30/6LAN	27	42	15	Al	1
296/33/6LAN	30	43	13,25	Al	1
296/35/6LAN	32	47	15	Al	1
296/38/6LAN	35	48	13,25	Al	1
296/25/6U	18	33	15	Al	1
296/30/6U	23	38	15	Al	1
296/35/6U	28	43	15	Al	1

MULTIPUNTO PALANCA BASCULANTE ENTRE EJES 85 mm. SERIE 296

DESCRIPCIÓN	REF.	MEDIDAS		LEVA	ACABADOS		UDS	
		B	A		FRENTE	CILINDRO		
	296A25/6L	22	37	15	Al		1	
	296A28/6L	25	38	13,25	Al		1	
	296A30/6L	27	42	15	Al		1	
	296A33/6L	30	43	13,25	Al		1	
	296A35/6L	32	47	15	Al		1	
	296A38/6L	35	48	13,25	Al		1	
	296A25/6LAN	22	37	15	Al		1	
	296A28/6LAN	25	38	13,25	Al		1	
	296A30/6LAN	27	42	15	Al		1	
	296A33/6LAN	30	43	13,25	Al		1	
	296A35/6LAN	32	47	15	Al		1	
	296A38/6LAN	35	48	13,25	Al		1	
	296A25/6U	18	33	15	Al		1	
	296A30/6U	23	38	15	Al		1	
	296A35/6U	28	43	15	Al		1	

- Sólo palanca
- Cilindro no incluido

Opciones de cerradero
 (ver páginas 39 - 45)

	296V25/6L	22	37	15	Al		1	
	296V28/6L	25	38	13,25	Al		1	
	296V30/6L	27	42	15	Al		1	
	296V33/6L	30	43	13,25	Al		1	
	296V35/6L	32	47	15	Al		1	
	296V38/6L	35	48	13,25	Al		1	
	296V25/6LAN	22	37	15	Al		1	
	296V28/6LAN	25	38	13,25	Al		1	
	296V30/6LAN	27	42	15	Al		1	
	296V33/6LAN	30	43	13,25	Al		1	
	296V35/6LAN	32	47	15	Al		1	
	296V38/6LAN	35	48	13,25	Al		1	
	296V25/6U	18	33	15	Al		1	
	296V30/6U	23	38	15	Al		1	
	296V35/6U	28	43	15	Al		1	

- Rodillo vaivén regulable y palanca
- Cilindro no incluido

Opciones de cerradero
 (ver páginas 39 - 45)

MULTIPUNTO PALANCA BASCULANTE ENTRE EJES 85 mm.

SERIES 396

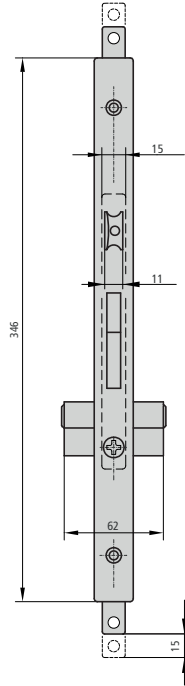

CARACTERÍSTICAS

- Cerradura de 3 puntos central y alto/bajo mediante llave
- Frente liso inox de 22 mm y U 24,5*6 mm
- Frente de 346 mm de largo
- Picaporte de 11 mm reversible y regulable
- Caja de 15 mm
- Cuadradillo de 8 mm
- 2 escudos de nylon ref. E51984
- Tornillo de fijación de cilindro

ACCESORIOS OPCIONALES

- Gama completa de cerraderos (ver páginas 39 - 45)
- Gama completa de cilindros (ver página 119 - 140)
- Accesorios 396 (ver página 49)

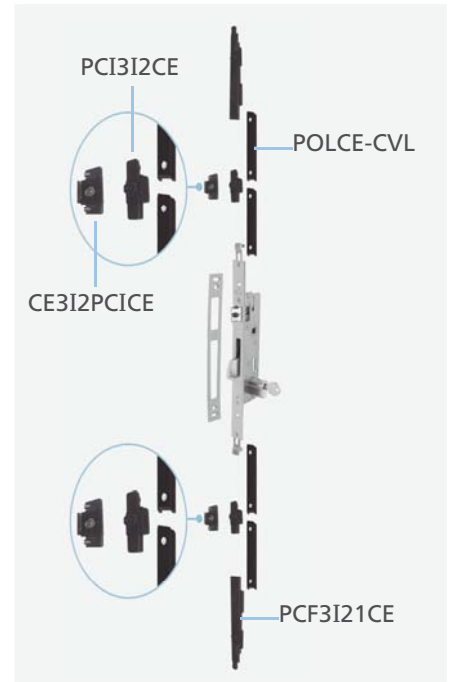

DESCRIPCIÓN

REF.

MEDIDAS

LEVA

ACABADOS

UDS

B

A

FRENTE

CILINDRO



- Picaporte y palanca
 - Cilindro no incluido
- Opciones de cerraderos**
(ver páginas 39 - 45)
- Opción de cerradero eléctrico**
(ver página 46)

396/25/6L

22

37

15

Al

1

10

396/30/6L

27

42

15

Al

1

10

396/35/6L

32

47

15

Al

1

10

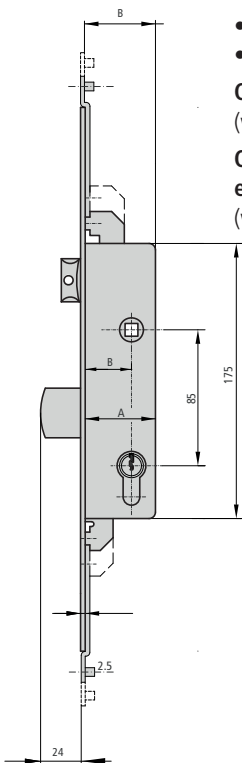

PALANCA DESLIZANTE ENTRE EJES 92 mm.

SERIE 192

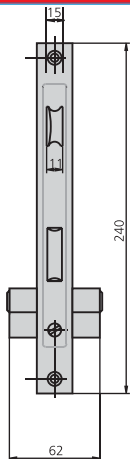

CARACTERÍSTICAS

- Frente inox de 16 mm, 22 mm o 24 mm
- Picaporte reversible de 11 mm
- Caja de 15 mm
- Cuadradillo de 8 mm
- 2 escudos de nylon ref. ES1984
- Tornillo de fijación de cilindro

ACCESORIOS OPCIONALES

- Gama completa de cerraderos (ver páginas 39 - 45)
- Gama completa de cilindros (ver página 119 - 140)

DESCRIPCIÓN

REF.

MEDIDAS

LEVA

ACABADOS

UDS

B

A

FRENTE

CILINDRO

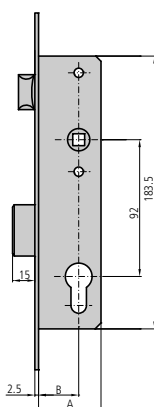

- Picaporte y palanca
- No incluye cilindro

Opciones de cerradero
(ver páginas 39 - 45)

Opción de cerradero eléctrico
(ver página 46)

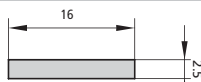

P192/25/6	22	37	15	Al	CN	1	20
P192/30/6	27	42	15	Al	CN	1	20
P192/35/6	32	47	15	Al	CN	1	20

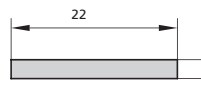

192/25/6	22	37	15	Al	CN	1	20
192/30/6	27	42	15	Al	CN	1	20
192/35/6	32	47	15	Al	CN	1	20

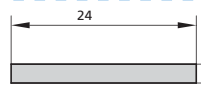

192/25/6AN	22	37	15	Al	CN	1	20
192/30/6AN	27	42	15	Al	CN	1	20
192/35/6AN	32	47	15	Al	CN	1	20

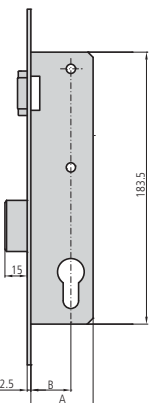

- Rodillo vaivén regulable y palanca
- No incluye cilindro

Opciones de cerradero
(ver páginas 39 - 45)

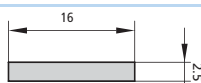

P192V25/6	22	37	15	Al	CN	1	20
P192V30/6	27	42	15	Al	CN	1	20
P192V35/6	32	47	15	Al	CN	1	20

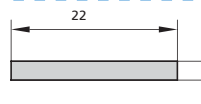

192V25/6	22	37	15	Al	CN	1	20
192V30/6	27	42	15	Al	CN	1	20
192V35/6	32	47	15	Al	CN	1	20

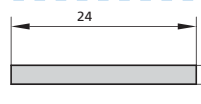

192V25/6AN	22	37	15	Al	CN	1	20
192V30/6AN	27	42	15	Al	CN	1	20
192V35/6AN	32	47	15	Al	CN	1	20

PUERTAS BATIENTES

PALANCA BASCULANTE ENTRE EJES 92 mm.

SERIE 194

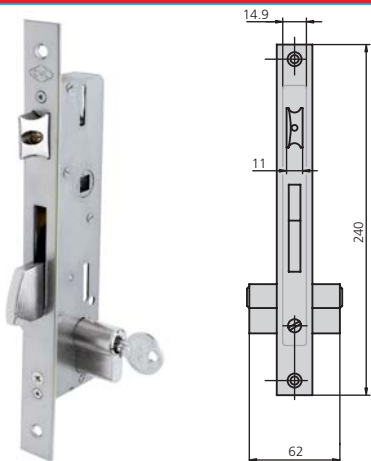

CARACTERÍSTICAS

- Frente liso inox de 22 mm o 24 mm ó frente inox en U de 24,5x6
- Picaporte reversible de 11 mm
- Picaporte regulable excepto en entrada 25 mm
- Caja de 15 mm
- Cuadradillo de 8 mm
- 2 escudos de nylon ref. ES1984
- Tornillo de fijación de cilindro

ACCESORIOS OPCIONALES

- Gama completa de cerraderos (ver páginas 39 - 45)
- Gama completa de cilindros (ver página 119 - 140)
- Escudo de seguridad pasante BTI296 (ver página 48)

DESCRIPCIÓN	REF.	MEDIDAS		LEVA	ACABADOS		UDS	
		B	A		FRENTE	CILINDRO		

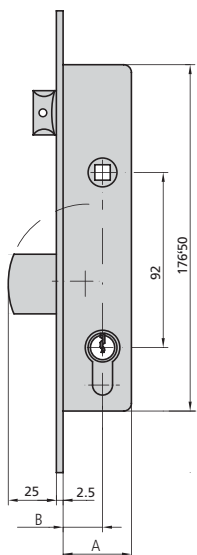

- Picaporte y palanca
- No incluye cilindro

Opciones de cerradero
(ver páginas 39 - 45)

Opción de cerradero eléctrico
(ver página 46)

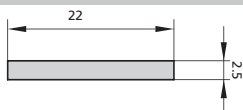

194/25/6	22	37	15	AI	CN	1	20
194/30/6	27	42	15	AI	CN	1	20
194/35/6	32	47	15	AI	CN	1	20

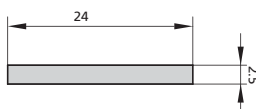

194/25/6AN	22	37	15	AI	CN	1	20
194/30/6AN	27	42	15	AI	CN	1	20
194/35/6AN	32	47	15	AI	CN	1	20

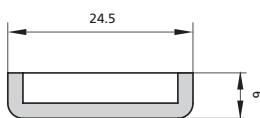

194/25/6U	18	33	15	AI U	CN	1	20
194/30/6U	23	38	15	AI U	CN	1	20
194/35/6U	28	43	15	AI U	CN	1	20

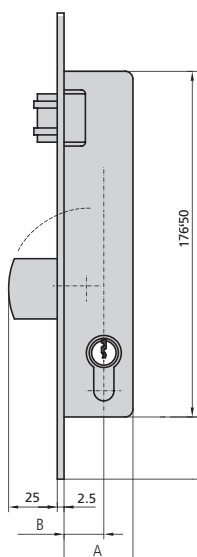

- Rodillo vaivén regulable y palanca.
- No incluye cilindro

Opciones de cerradero
(ver páginas 39 - 45)

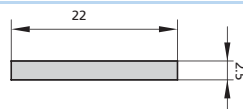

194V25/6	22	37	15	AI	CN	1	20
194V30/6	27	42	15	AI	CN	1	20
194V35/6	32	47	15	AI	CN	1	20

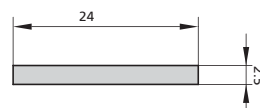

194V25/6AN	22	37	15	AI	CN	1	20
194V30/6AN	27	42	15	AI	CN	1	20
194V35/6AN	32	47	15	AI	CN	1	20

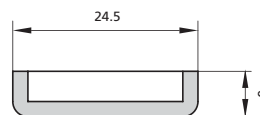

194V25/6U	18	33	15	AI U	CN	1	20
194V30/6U	23	38	15	AI U	CN	1	20
194V35/6U	28	43	15	AI U	CN	1	20

MULTIPUNTO PALANCA BASCULANTE ENTRE EJES 92 mm.

SERIE 294

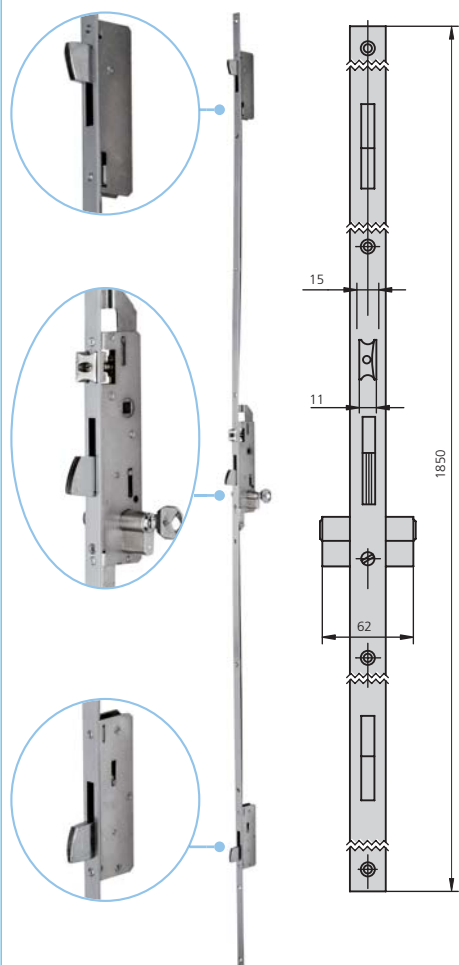

CARACTERÍSTICAS

- Frente liso inox de 1850x22 mm o 1850x24 mm o frente U de 1850x24,5x6
- Picaporte reversible de 11 mm
- Picaporte regulable excepto en entrada 25 mm
- Caja de 15 mm
- Cuadradillo de 8 mm
- Tornillo de fijación de cilindro

ACCESORIOS OPCIONALES

- Gama completa de cerraderos (ver páginas 39 - 45)
- Gama completa de cilindros (ver página 119 - 140)
- Frente de 2300 mm de largo opcional (serie 494)
- Frente de 1500 mm de largo opcional (serie 594)

DESCRIPCIÓN	REF.	MEDIDAS		LEVA	ACABADOS		UDS	
		B	A		FRENTE	CILINDRO		

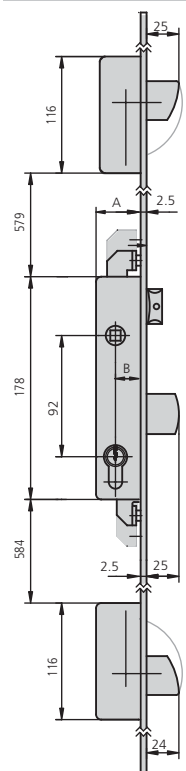

- Picaporte y palanca
- Cilindro no incluido

Opciones de cerradero
(ver páginas 39 - 45)

Opción cerradero eléctrico
(ver página 46)

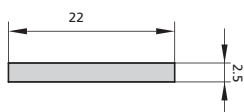

294/25/6L	22	37	15	Al	1
294/30/6L	27	42	15	Al	1
294/35/6L	32	47	15	Al	1

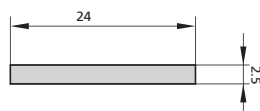

294/25/6LAN	22	37	15	Al	1
294/30/6LAN	27	42	15	Al	1
294/35/6LAN	32	47	15	Al	1

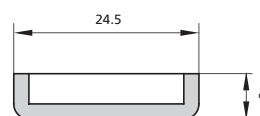

294/25/6U	18	33	15	Al	1
294/30/6U	23	38	15	Al	1
294/35/6U	28	43	15	Al	1

PUERTAS BATIENTES

MULTIPUNTO PALANCA BASCULANTE ENTRE EJES 92 mm.

SERIE 294

DESCRIPCIÓN	REF.	MEDIDAS		LEVA	ACABADOS		UDS	
		B	A		FRENTE	CILINDRO		
<ul style="list-style-type: none"> Rodillo vaivén regulable y palanca Cilindro no incluido <p>Opciones de cerradero (ver páginas 39 - 45)</p>								

ACCESORIOS

CERRADEROS

UDS

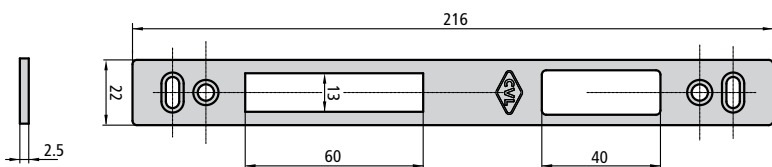

- Cerradero fijo de hierro niquelado CE184/0L
- Cerradero fijo de acero inoxidable CE184/6L

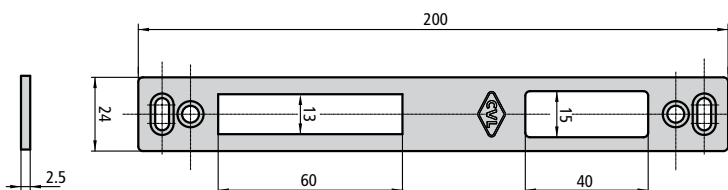

- Cerradero fijo de hierro niquelado CE184/0LAN
- Cerradero fijo de acero inoxidable CE184/6LAN

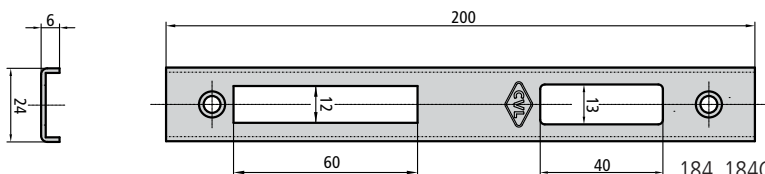

- Cerradero fijo de acero inoxidable CE184/6U
- 184, 184C, 184V, 192, 192C, 192V, F192, 1E5, central 2E5, 1E2, central 2E2, 2E2GB, 615, 615E, 2I2, 2I2GB, 3I2

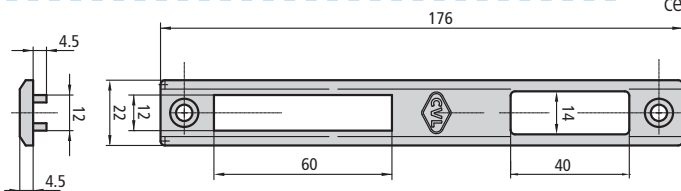

- Cerradero fijo metálico negro CE184/1N

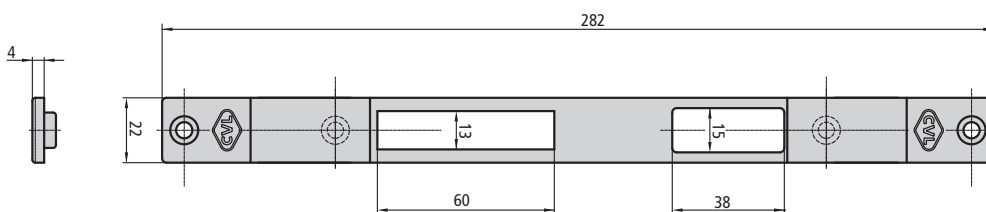

- Cerradero regulable metálico negro CE184/1NR

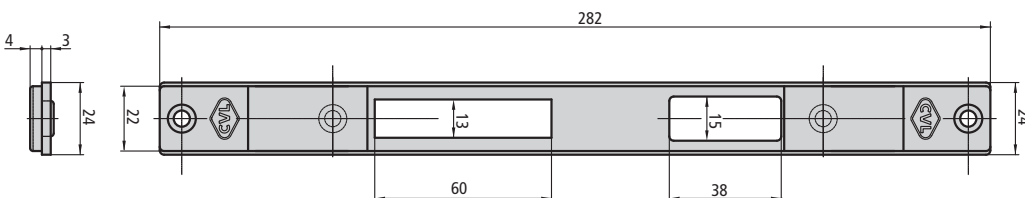

- Cerradero regulable metálico negro con suplemento CE184/1NRS

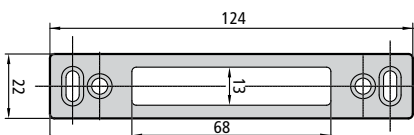

184A

- Cerradero fijo de hierro niquelado CE184A/0L
- Cerradero fijo de acero inoxidable CE184A/6L

ACCESORIOS

CERRADEROS

DESCRIPCIÓN

REF.

APLICABLE A CERRADURAS

UDS

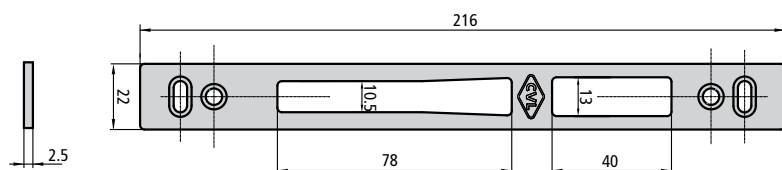

- Cerradero fijo de acero inoxidable CE196/6L

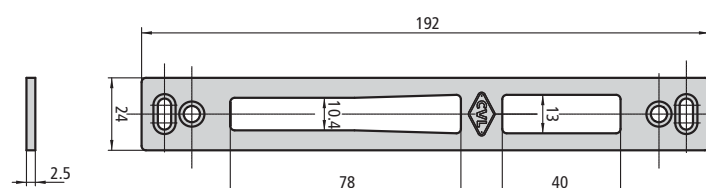

- Cerradero fijo de acero inoxidable CE196/6LAN

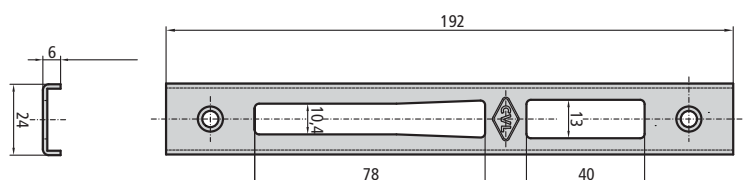

- Cerradero fijo de acero inoxidable con levas CE196/6U
- 196, 196C, 196V, 197, 194, 194C, 194V, central 296, 296V, 396, 496, 496V, 596, 596V, 294, 294V, 494, 494V

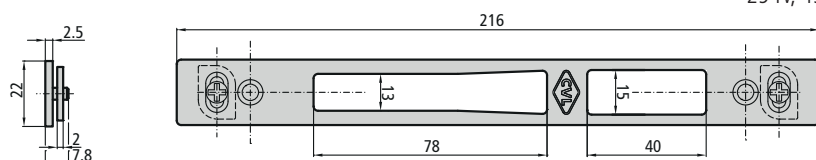

- Cerradero regulable de acero inoxidable con levas CE196/6LR

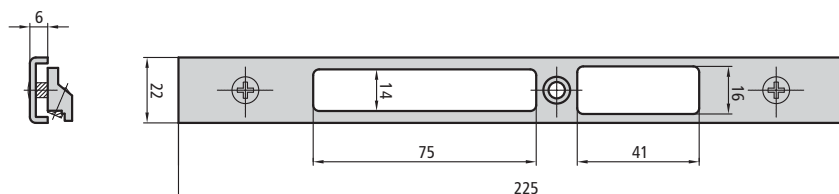

- Cerradero regulable inox en U CE196/6RU

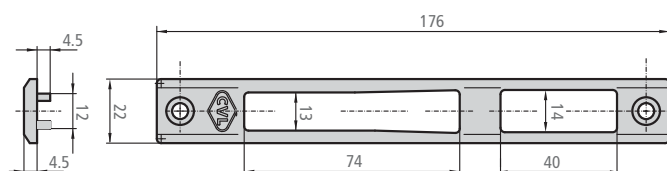

- Cerradero fijo metálico negro CE196/1N

ACCESORIOS

CERRADEROS

DESCRIPCIÓN	REF.	APLICABLE A CERRADURAS	UDS  
-------------	------	------------------------	---

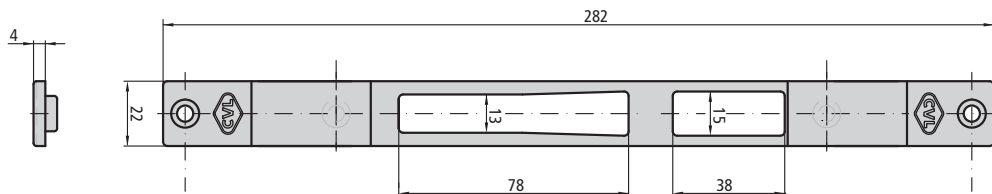

196, 196C, 196V, 197,
194, 194C, 194V,
central 296, 296V, 396,
496, 496V, 596, 596V,
294, 294V, 494, 494V

- Cerradero regulable metálico negro CE196/1NR

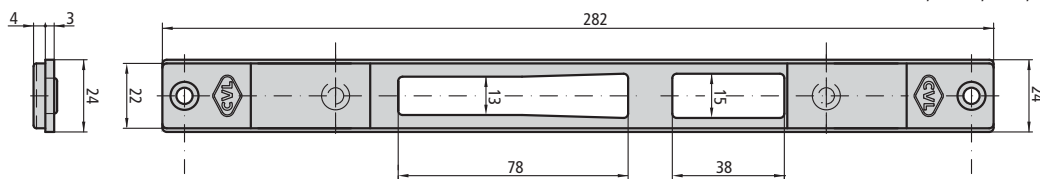

- Cerradero regulable metálico negro con suplemento CE196/1NRS

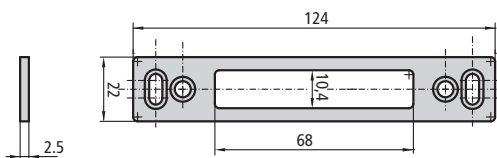

- Cerradero fijo de acero inoxidable para solo palanca CE296S/6L

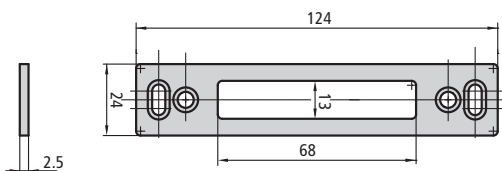

- Cerradero fijo de acero inoxidable para solo palanca CE296S/6LAN

196A, 197K, 296A, 496A, 596A,
294A, 494A, suplementos alto/bajo
de las series 296, 496, 596, 294,
494, 2E5, 2E2, 2K2, 2K5

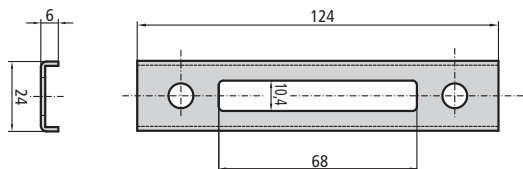

- Cerradero fijo de acero inoxidable para solo palanca CE296S/6U

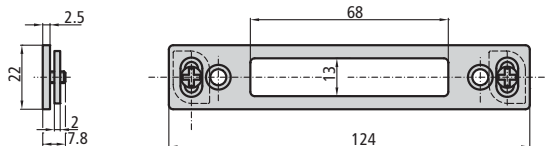

- Cerradero regulable de acero inoxidable con levas CE296S/6LR

PUERTAS BATIENTES

ACCESORIOS

CERRADEROS

DESCRIPCIÓN	REF.	APLICABLE A CERRADURAS	UDS  
-------------	------	------------------------	---

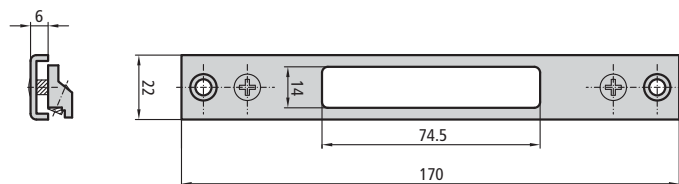

- Cerradero regulable inox en U solo palanca CE296S/6RU

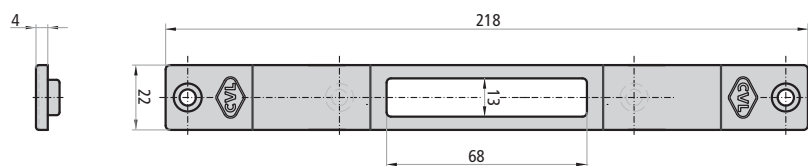

- Cerradero regulable metálico negro CE296S/1NR

196A, 197K, 296A, 496A, 596A, 294A, 494A, suplementos alto/bajo de las series 296, 496, 596, 294, 494, 2E5, 2E2, 2K2 2K5

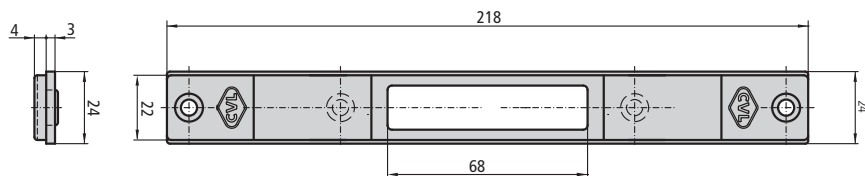

- Cerradero regulable metálico negro con suplemento CE296S/1NRS

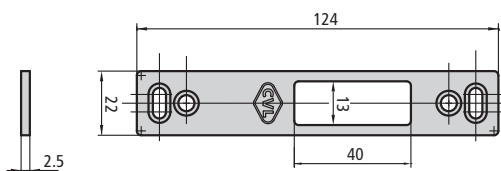

- Cerradero fijo de acero inoxidable para solo picaporte CE196R/6L

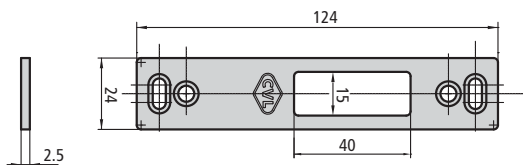

- Cerradero fijo de acero inoxidable para solo picaporte CE196R/6LAN

196R, 196RV, 196T, 194T

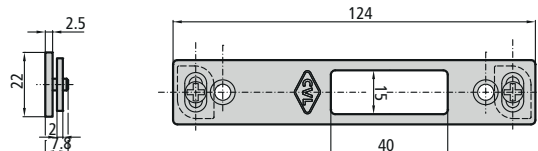

- Cerradero regulable de acero inoxidable con levas CE196R/6LR

ACCESORIOS **CERRADEROS**

DESCRIPCIÓN	REF.	APLICABLE A CERRADURAS	UDS
-------------	------	------------------------	-----

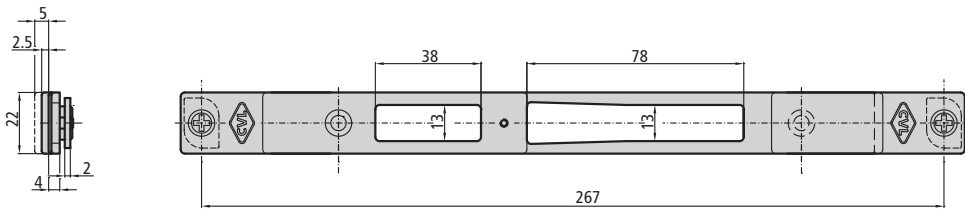

- Cerradero regulable metálico negro, incluye 1 suplemento de 2,5 mm y otro de 5 mm KCE1K5/1NR 1K2, 1K5, central 2K2, central 2K5

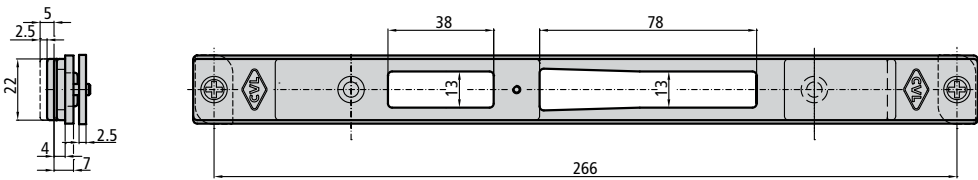

- Cerradero regulable metálico negro con suplemento, incluye 1 suplemento de 2,5 mm y otro de 5 mm KCE1K5/1NRS 1K2, 1K5, central 2K2, central 2K5

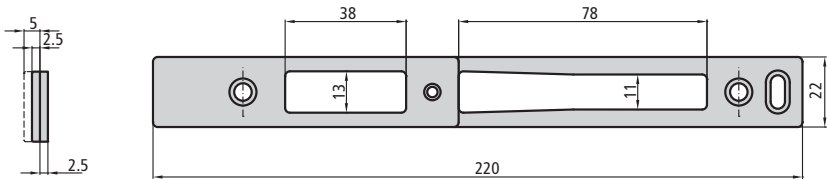

- Cerradero fijo de acero inoxidable de 22 mm, incluye 1 suplemento de 2,5 mm y otro de 5 mm KCE1K5/6L 1K2, 1K5, central 2K2, central 2K5

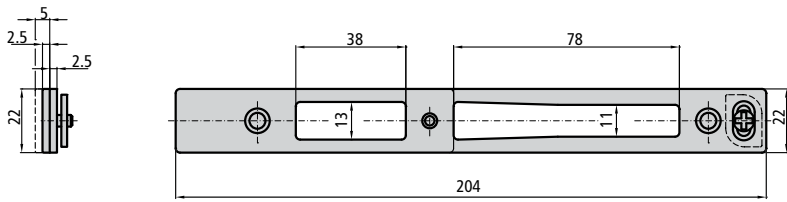



- Cerradero regulable de acero inoxidable, incluye 1 suplemento de 2,5 mm y otro de 5 mm con levas KCE1K5/6LR 1K2, 1K5, central 2K2, central 2K5

PUERTAS BATIENTES

ACCESORIOS

CERRADEROS

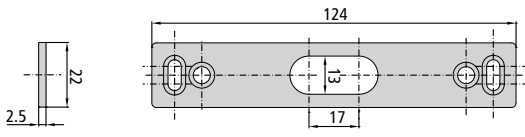
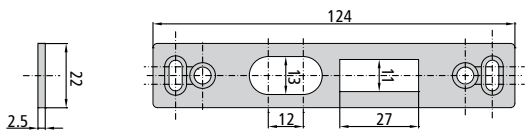
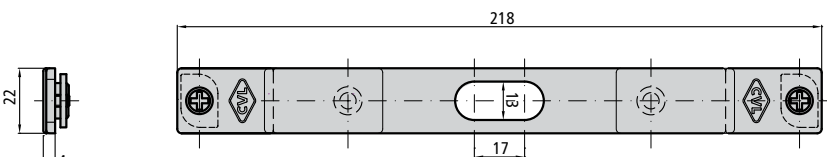
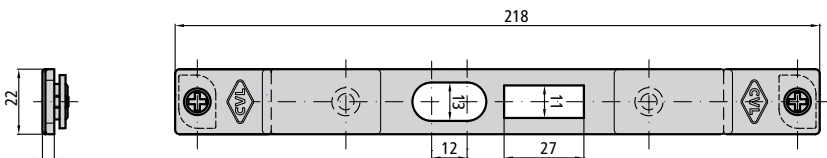
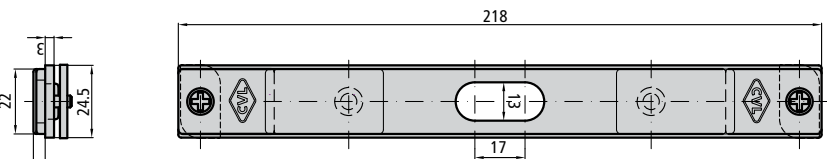
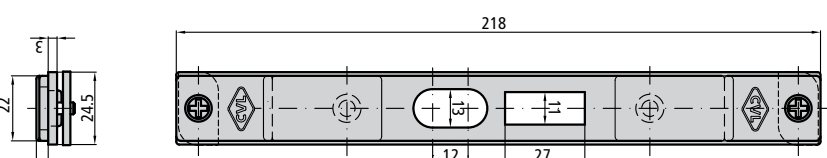
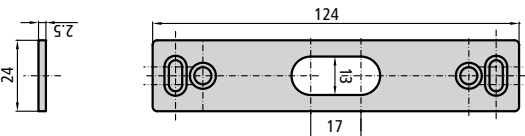
DESCRIPCIÓN	REF.	APLICABLE A CERRADURAS	UDS  
	CE202S/6L	alto / bajo 2I2	-----
	CE202GB/6L	alto / bajo 2I2GB, 2E2GB	-----
	CE202S/1NR	alto / bajo 2I2	-----
	CE202GB/1NR	alto / bajo 2I2GB, 2E2GB	-----
	CE202S/1NRS	alto / bajo 2I2 con suplemento	-----
	CE202GB/1NRS	alto / bajo 2I2GB, 2E2GB	-----
	CE202S/6LAN	alto / bajo 2I2	-----

ACCESORIOS

CERRADEROS

DESCRIPCIÓN	REF.	APLICABLE A CERRADURAS	UDS
	CE202GB/6LAN	alto / bajo 2I2GB, 2E2GB	
	CE202S/6LR18	alto / bajo 2I2	
	CE202GB/6LR18	alto / bajo 2I2GB, 2E2GB	
	CE202S/6LR20	alto / bajo 2I2	
	CE202GB/6LR20	alto / bajo 2I2GB, 2E2GB	
	CE202S/6U	alto / bajo 2I2	

PUERTAS BATIENTES

ACCESORIOS

CERRADEROS ELÉCTRICOS

DESCRIPCIÓN	REF.	APLICABLE A CERRADURAS	UDS  
-------------	------	------------------------	---

- Cerradero eléctrico regulable reversible con funcionamiento automático y con desbloqueo
- Frente plano inox
- 12V/Corriente alterna

CEC41/6AD 184, 196, 197, 296, 396, 496, 596, 192, F192,
194, 294, 494, 183, 612, 612E, 615E, 615

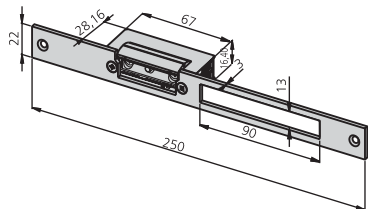

- Cerradero eléctrico regulable reversible con funcionamiento automático y con desbloqueo
- Sólo picaporte y frente plano inox
- 12V/Corriente alterna

CEC41T/6AD 196T, 194T, 183T

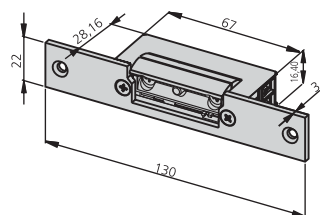

* Otros tipos de cerradero eléctrico consultar.

ACCESORIOS

ESCUDOS Y MANILLAS DE ACERO INOXIDABLE

DESCRIPCIÓN	REF.	ACABADO	CANTO SERIES	UDS
<ul style="list-style-type: none"> Juego escudo con manilla y bocallave cilindro para aluminio Entre ejes 85 mm No incluye cilindro 	JM6006/85/6R	Al	Red.	2
<ul style="list-style-type: none"> Juego roseta para aluminio más juego escudo 	JMB6000/6R	Al	Red.	2
<ul style="list-style-type: none"> Juego escudo para cilindro 	JES6000/6R	Al	Red.	2
<ul style="list-style-type: none"> Juego placa con tirador y bocallave de cilindro No incluye cilindro 	JT6006/85/6R	Al	Red.	2

PUERTAS BATIENTES

ACCESORIOS

ESCUDOS

DESCRIPCIÓN	REF.	ACABADO	CANTO SERIES	UDS
<ul style="list-style-type: none"> • Escudo de seguridad no pasante, 1 escudo de zamak y 2 tornillos 	BT194/1N	NEGRO		
<p>NEGRO</p>				
<ul style="list-style-type: none"> • Escudo de seguridad pasante con contraescudo, 1 escudo de zamak, capucha de nylon para contraescudo y dos tornillos pasantes • 1 escudo de zamak 	BT1296/1N	NEGRO		
<p>NEGRO</p>				
<ul style="list-style-type: none"> • Escudo de nylon 	ES1984	NEGRO		

ACCESORIOS

OTROS

DESCRIPCIÓN	REF.	APLICABLE A SERIES	UDS
 <ul style="list-style-type: none"> • Terminales de nylon 	EMB196	184, 192, 196, 197, 194, 1E5, 1E2, 1K5	10
 <ul style="list-style-type: none"> • Conjunto vaivén para la serie SOFT 	CV1E5	1E5, 2E5, 1E2, 2E2	10
 <ul style="list-style-type: none"> • Tapa resbalón para la serie SOFT 	TAP1E5	1E5, 2E5, 1E2, 2E2	10
 <ul style="list-style-type: none"> • Poliamida extrudida para perfiles de Cámara Europea 	POLCE-CVL	3I2, 396	100 m
 <ul style="list-style-type: none"> • Punto de cierre final para cámara europea y con un cierre adicional 	PCF3I21CE	3I2, 396	
 <ul style="list-style-type: none"> • Punto de cierre intermedio para cámara europea 	PCI3I2CE	3I2, 396	
 <ul style="list-style-type: none"> • Cerradero regulable para cámara europea y punto de cierre intermedio 	CE3I2PCICE	3I2, 396	
 <ul style="list-style-type: none"> • Contacto con muelles que se empotran en el marco de la puerta sin dejar cables visibles 	CONNECT01	1K5, 1K2, 2K5, 2K2	

MULTIPUNTO PALANCA GANCHO ENTRE EJES 85 mm.

SERIE 4I54KD

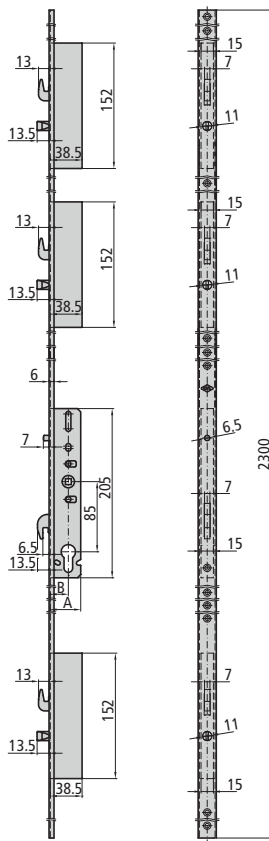

CARACTERÍSTICAS

- Cerraduras para puertas correderas
- Cerradura de 4 puntos con facilidad de cierre mediante manilla hacia arriba (90°) y bloqueo mediante llave
- Cierre mediante 4 ganchos y 3 bulones deslizantes
- Sistema de bloqueo de manilla en modo de puerta abierta
- Posibilidad de atado de manilla a 21,5 mm ↑↓ pasante o directo a la cerradura
- Frente inox U de 2300 x 16 x 6 y 2300 x 22 x 6
- Caja cerrada de 15 mm
- Cuadradillo de 7 mm
- Tornillo de fijación de cilindro

ACCESORIOS OPCIONALES

- Gama completa de cilindros (ver página 119 - 140)

DESCRIPCIÓN

REF.

MEDIDAS
B A

LEVA

ACABADOS
FRENTE CILINDRO

UDS

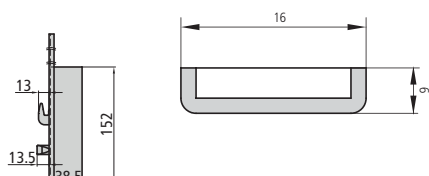
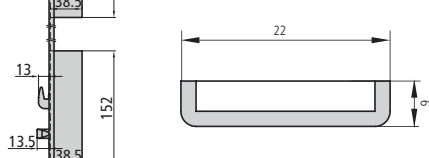

DESCRIPCIÓN	REF.	MEDIDAS B A	LEVA	ACABADOS FRENTE CILINDRO	UDS
	4I54KD256U16	18 33	15	Al	1
	4I54KD256U22	18 33	15	Al	1



- Solo palanca gancho
- Cilindro no incluido

MULTIPUNTO PALANCA GANCHO ENTRE EJES 85 mm.

SERIE 2I5KD

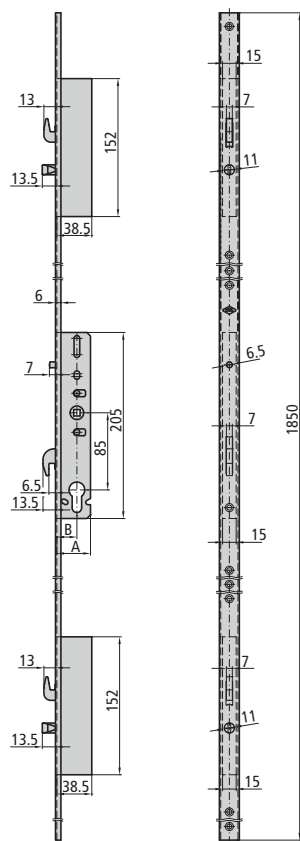

CARACTERÍSTICAS

- Cerraduras para puertas correderas
- Cerradura de 3 puntos con facilidad de cierre mediante manilla hacia arriba (90°) y bloqueo mediante llave
- Cierre mediante 3 ganchos y 2 bulones deslizantes
- Sistema de bloqueo de manilla en modo de puerta abierta
- Posibilidad de atado de manilla a 21,5 mm ↑↓ pasante o directo a la cerradura
- Frente inox U de 1850 x 16 x 6 y 1850 x 22 x 6
- Caja cerrada de 15 mm
- Cuadradillo de 7 mm
- Tornillo de fijación de cilindro

ACCESORIOS OPCIONALES

- Gama completa de cilindros (ver página 119 - 140)

DESCRIPCIÓN	REF.	MEDIDAS		LEVA	ACABADOS		UDS	
		B	A		FRENTE	CILINDRO		

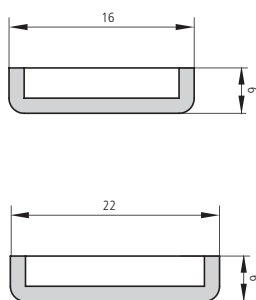
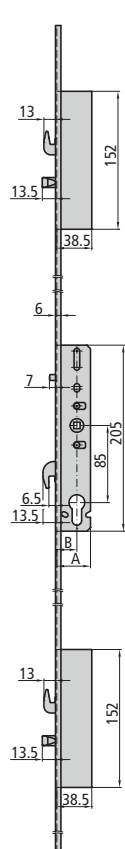

	2I5KD25/6U16	18	33	15	Al		1
	2I5KD25/6U22	18	33	15	Al		1

- Solo palanca gancho
- Cilindro no incluido

MULTIPUNTO PALANCA GANCHO ENTRE EJES 85 mm.

SERIE 297K

CARACTERÍSTICAS

- Para puertas correderas
- Frente inox U de 1850x16x6 mm
- Caja de 15 mm
- Cuadradillo de 8 mm
- Tornillo de fijación de cilindro

ACCESORIOS OPCIONALES

- Gama completa de cilindros (ver página 119 - 140)

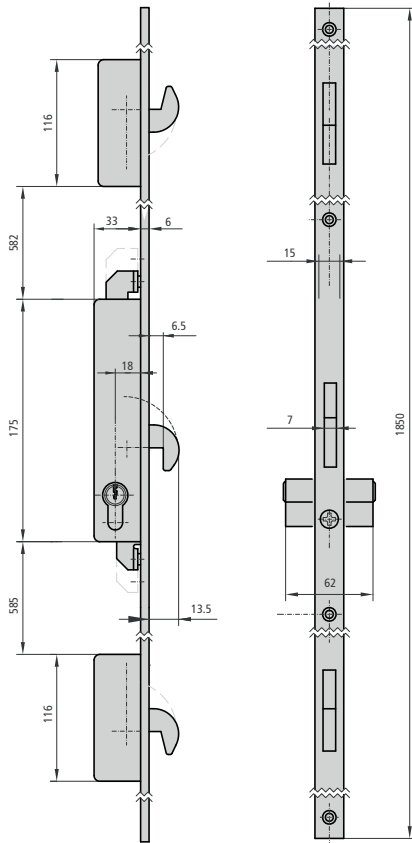

DESCRIPCIÓN

REF.

MEDIDAS

LEVA

ACABADOS

UDS

B

A

FRENTE

CILINDRO



297K25/6U16

18

33

15

Al

1

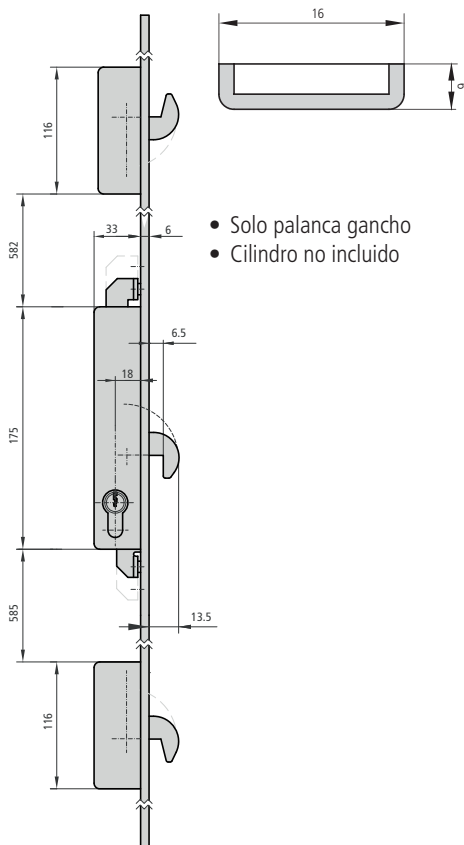

- Solo palanca gancho
- Cilindro no incluido

PALANCA GANCHO ENTRE EJES 85 mm.

SERIE 198K

CARACTERÍSTICAS

- Frente inox de 16 mm ó 22 mm
- Caja de 15 mm
- 2 escudos de nylon ref. ES1984
- Tornillo de fijación de cilindro

ACCESORIOS OPCIONALES

- Gama completa de cilindros (ver página 119 - 140)

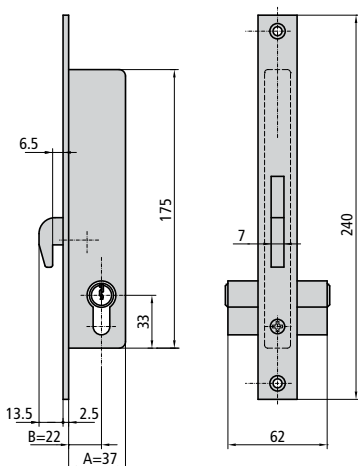

DESCRIPCIÓN

REF.

MEDIDAS
B A

LEVA

ACABADOS
FRENTES CILINDRO

UDS

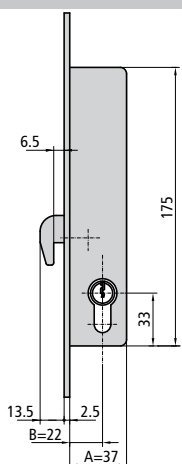

- Cerradura para puerta corredera
- Sólo palanca gancho
- Cilindro de leva larga 5982/2525/4

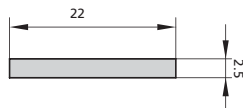
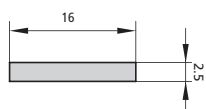

P198K25/6	22	37	15	AI	CN	1	20
P198K30/6	27	42	15	AI	CN	1	20
P198K35/6	32	47	15	AI	CN	1	20

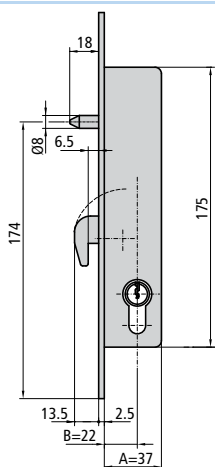

- Cerradura para puerta corredera
- Sólo palanca gancho con pin de seguridad
- Cilindro de leva larga 5982/2525/4

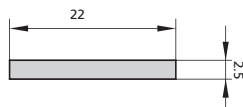
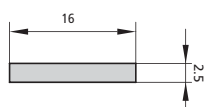

P198KB25/6	22	37	15	AI	CN	1	20
P198KB30/6	27	42	15	AI	CN	1	20
P198KB35/6	32	47	15	AI	CN	1	20

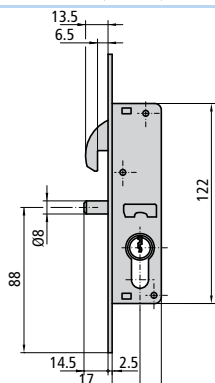



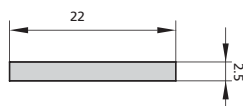
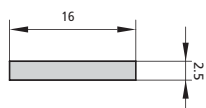

- Cerradura para puerta corredera
- Sólo palanca gancho
- Pin deslizantes
- Cilindro de leva corta 5990/2525/4



P198KD20/6	17	30	13,25	AI	CN	1	20
198KD20/6	17	30	13,25	AI	CN	1	20

ACCESORIOS

MANILLAS

DESCRIPCIÓN	REF.	ACABADO	CANTO SERIES	UDS
 <ul style="list-style-type: none"> Juego roseta para puerta corredera aluminio 	JM2I5KD/1NR	NEGRO	2I5KD 4I54KD	 
 <ul style="list-style-type: none"> Juego roseta más juego escudo para puerta corredera aluminio 	JMB2I5KD/1NR	NEGRO	2I5KD 4I54KD	

CERRADURAS DE EMBUTIR PARA CARPINTERÍA METÁLICA



Palanca deslizante entre ejes 85 cilindro europerfil leva corta	56
• Serie 1984	56
Palanca deslizante entre ejes 85 cilindro europerfil leva larga	58
• Serie 1995	58
Palanca gancho entre ejes 85 cilindro europerfil	60
• Serie 190	60
• Serie 1990	61
• Serie 1994	62
Multipunto palanca gancho entre ejes 85	64
• Serie 2994	64
Multipunto palanca gancho entre ejes 85	66
• Serie 3994	66
Palanca deslizante entre ejes 92 cilindro europerfil	68
• Serie 1992	68
Palanca deslizante entre ejes 70 cilindro europerfil	69
• Serie 1983	69
Palanca deslizante entre ejes 85 cilindro ovalado monoblock	71
• Serie 1963	71
• Serie 1975	73
Palanca deslizante entre ejes 74 cilindro ovalado de vástagos	74
• Serie 1964	74
Cerradura para puertas de zócalo con cilindro ovalado de vástagos	76
• Serie 1981	76
Cerradura para puertas de zócalo con cilindro europerfil	77
• Serie 1991	77
Cerradura de sólo gancho con cilindro ovalado de vástagos	78
• Serie 1968	78
Cerradura de sólo gancho con cilindro europerfil	79
• Serie 1982	79
Cerradura de sólo picaporte para puertas metálicas	80
• Serie 1979	80
Cerradura para puertas y persianas metálicas enrollables	81
• Serie 11A	81
• Serie 11E	82
Cerradura para puertas metálicas basculantes	83
• Serie 11B	83
Accesorios	84
• Cerraderos para cerraduras metálicas	84
• Cerraderos eléctricos	87
• Escudos	88
• Escudos de seguridad	88

PALANCA DESLIZANTE ENTRE EJES 85 CILINDRO EUROPERFIL LEVA CORTA

SERIE 1984

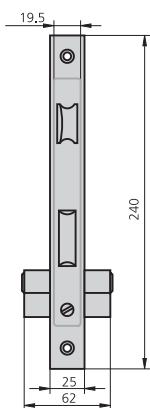

CARACTERÍSTICAS

- Frente hierro niquelado ó acero inoxidable
- Caja bicromatada
- Palanca deslizante
- Picaporte reversible
- Cuadradillo de 8 mm
- Cilindro europerfil
- 2 escudos de nylon ref. ES1984
- Tornillo de fijación de cilindro

ACCESORIOS OPCIONALES

- Cerraderos según cerradura (ver abajo)
- Gama completa de cilindros (ver páginas 119 - 140)

DESCRIPCIÓN	REF.	MEDIDAS		LEVA	ACABADOS		UDS	
		B	A		FRENTE	CILINDRO		
<ul style="list-style-type: none"> • Picaporte y palanca • Cilindro 5990/2525 Opciones de cerradero • CE1984/0 o CE1984/6 Opción cerraderos eléctricos • CEC45/6A • CEC45/6AD 	1984/20/0	20	33	13,25	HN	CN	1	20
	1984/20/5	20	33	13,25	HN	CL	1	20
	1984/20/6	20	33	13,25	AI	CN	1	20
	1984/25/0	25	38	13,25	HN	CN	1	20
	1984/25/5	25	38	13,25	HN	CL	1	20
	1984/25/6	25	38	13,25	AI	CN	1	20
	1984/30/0	30	43	13,25	HN	CN	1	20
	1984/30/5	30	43	13,25	HN	CL	1	20
	1984/30/6	30	43	13,25	AI	CN	1	20

<ul style="list-style-type: none"> • Cerradura de condena • Sin cilindro Opciones de cerradero • CE1984/6 	1984C20/6	20	33		AI		2	40
	1984C25/6	25	38		AI		2	40
	1984C30/6	30	43		AI		2	40

PALANCA DESLIZANTE ENTRE EJES 85 CILINDRO EUROPERFIL LEVA CORTA

SERIE 1984

DESCRIPCIÓN	REF.	MEDIDAS		LEVA	ACABADOS		UDS	
		B	A		FRENTE	CILINDRO		

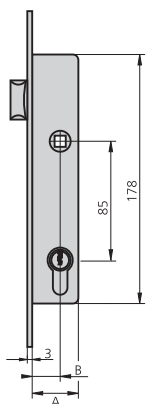

- Sólo picaporte
- Cilindro 5982T40/4

1984T20/6	20	33	15	Al	CN	1	20
1984T25/6	25	38	15	Al	CN	1	20
1984T30/6	30	43	15	Al	CN	1	20

Opción cerraderos eléctricos

- CEC45/6A o CEC45/6AD

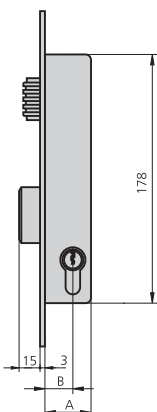

- Rodillo vaivén regulable y palanca
- Cilindro 5990/2525

1984V20/6	20	33	13,25	Al	CN	1	20
1984V25/6	25	38	13,25	Al	CN	1	20
1984V30/6	30	43	13,25	Al	CN	1	20

Opciones de cerradero

- CE1984/6

PALANCA DESLIZANTE ENTRE EJES 85 CILINDRO EUROPERFIL LEVA LARGA

SERIE 1995

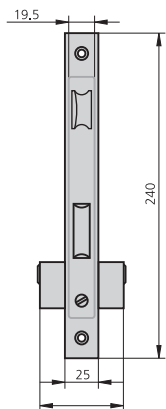

CARACTERÍSTICAS

- Frente hierro niquelado ó acero inoxidable
- Caja bicromatada
- Palanca deslizante
- Picaporte reversible
- Cuadradillo de 8 mm
- Cilindro europerfil
- 2 escudos de nylon ref. ES1984
- Tornillo de fijación de cilindro

ACCESORIOS OPCIONALES

- Cerraderos según cerradura (ver abajo)
- Amplia gama de cilindros (ver páginas 119 - 140)

DESCRIPCIÓN	REF.	MEDIDAS		LEVA	ACABADOS		UDS	
		B	A		FRENTE	CILINDRO		

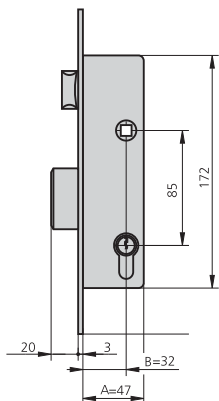

- Picaporte y palanca
- Cilindro 5982/2525

1995/32/0	32	47	15	HN	CN	1	20
1995/32/5	32	47	15	HN	CL	1	20
1995/32/6	32	47	15	AI	CN	1	20

- Opciones de cerradero**
- CE1984/0 o CE1984/6

- Opciones cerraderos eléctricos**

- CELC45/6A o CELC45/6AD

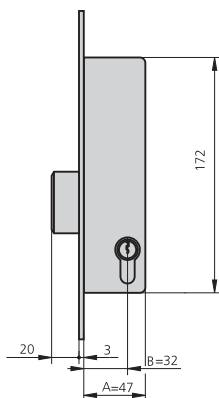

- Sólo palanca
- Cilindro 5982/2525/4

1995A32/6	32	47	15	AI	CN	1	20
-----------	----	----	----	----	----	---	----

- Opciones de cerradero**
- CE2994S/6

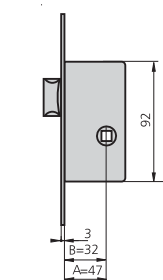

- Sólo picaporte
- Sin cilindro

1995R32/0	32	47		HN		1	30
-----------	----	----	--	----	--	---	----

PALANCA DESLIZANTE ENTRE EJES 85 CILINDRO EUROPERFIL LEVA LARGA SERIE 1995

DESCRIPCIÓN	REF.	MEDIDAS		LEVA	ACABADOS		UDS	
		B	A		FRENTE	CILINDRO		

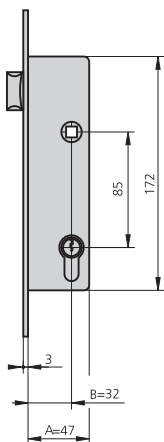

- Sólo picaporte
- Cilindro 5982T40/4

1995T32/6	32	47	15	Al	CN	1	20
-----------	----	----	----	----	----	---	----

Opciones cerraderos eléctricos

- CELC45T/6A o CELC45T/6AD

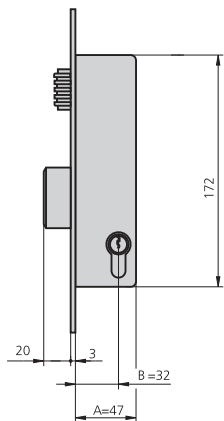

- Rodillo vaivén regulable y palanca
- Cilindro 5982/2525/4

1995V32/6	32	47	15	Al	CN	1	20
-----------	----	----	----	----	----	---	----

Opciones de cerradero

- CE1984/6

PALANCA GANCHO ENTRE EJES 85 CILINDRO EUROPERFIL

SERIE 190

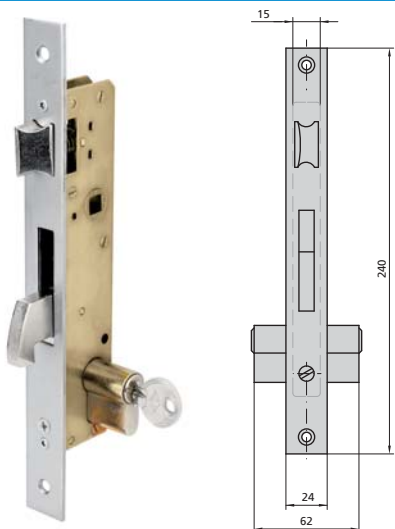

CARACTERÍSTICAS

- Frente de 24 mm
- Picaporte reversible
- Caja bicromatada de 15 mm
- Cuadradillo de 8 mm
- Cilindro europerfil
- 2 escudos de nylon ref. ES1984
- Tornillo de fijación de cilindro

ACCESORIOS OPCIONALES

- Gama completa de cilindros (ver páginas 119 - 140)

DESCRIPCIÓN	REF.	MEDIDAS		LEVA	ACABADOS		UDS	
		B	A		FRENTE	CILINDRO		

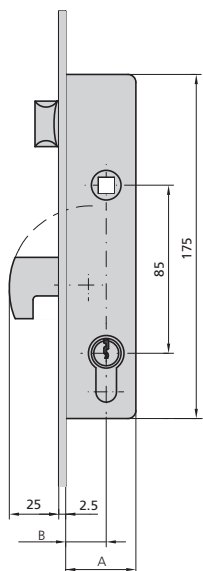

- Picaporte y palanca
- Cilindro 5990/2525

Opciones de cerradero

- CE190/0 o CE190/6

Opciones cerraderos eléctricos

- CELC45/6A o CELC45/6AD

190/23/0	20	33	13,25	HN	CN	1	20
190/23/5	20	33	13,25	HN	CL	1	20
190/23/6	20	33	13,25	AI	CN	1	20
190/28/0	25	38	13,25	HN	CN	1	20
190/28/5	25	38	13,25	HN	CL	1	20
190/28/6	25	38	13,25	AI	CN	1	20
190/33/0	30	43	13,25	HN	CN	1	20
190/33/5	30	43	13,25	HN	CL	1	20
190/33/6	30	43	13,25	AI	CN	1	20

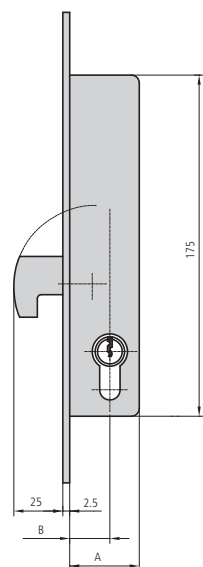

- Solo palanca
- Cilindro 5990/2525

Opciones de cerradero

- CE190/0 o CE190/6

190A23/0	20	33	13,25	HN	CN	1	20
190A23/5	20	33	13,25	HN	CL	1	20
190A23/6	20	33	13,25	AI	CN	1	20
190A28/0	25	38	13,25	HN	CN	1	20
190A28/5	25	38	13,25	HN	CL	1	20
190A28/6	25	38	13,25	AI	CN	1	20
190A33/0	30	43	13,25	HN	CN	1	20
190A33/5	30	43	13,25	HN	CL	1	20
190A33/6	30	43	13,25	AI	CN	1	20

PALANCA GANCHO ENTRE EJES 85 CILINDRO EUROPERFIL

SERIE 1990

CARPINTERÍA METÁLICA

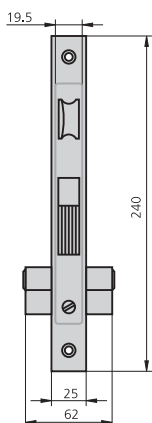

CARACTERÍSTICAS

- Frente hierro niquelado o acero inoxidable
- Caja bicromatada
- Palanca basculante de gancho
- Picaporte reversible
- Cuadradillo de 8 mm
- Cilindro europerfil
- 2 escudos de nylon ref. ES1984
- Tornillo de fijación de cilindro

ACCESORIOS OPCIONALES

- Gama completa de cilindros (ver páginas 119 - 140)

DESCRIPCIÓN	REF.	MEDIDAS		LEVA	ACABADOS		UDS	
		B	A		FRENTE	CILINDRO		

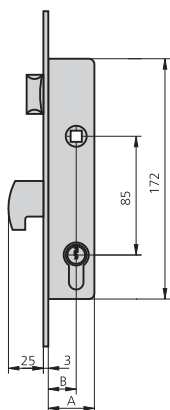

- Picaporte y palanca
- Cilindro 5990/2525 o 5982/2525
- Cerradero CE1990/0

Opciones cerraderos eléctricos

- CELC45/6A o CELC45/6AD

1990/20/0	20	33	13,25	HN	CN	1	20
1990/20/5	20	33	13,25	HN	CL	1	20
1990/20/6	20	33	13,25	Al	CN	1	20
1990/25/0	25	38	13,25	HN	CN	1	20
1990/25/5	25	38	13,25	HN	CL	1	20
1990/25/6	25	38	13,25	Al	CN	1	20
1990/32/0	32	47	15	HN	CN	1	20
1990/32/5	32	47	15	HN	CL	1	20
1990/32/6	32	47	15	Al	CN	1	20

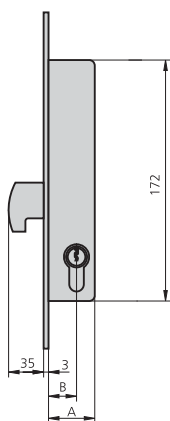

- Sólo palanca
- Cilindro 5990/2525 o 5982/2525
- Cerradero CE1990/0

1990A20/0	20	33	13,25	HN	CN	1	20
1990A20/5	20	33	13,25	HN	CL	1	20
1990A20/6	20	33	13,25	Al	CN	1	20
1990A25/0	25	38	13,25	HN	CN	1	20
1990A25/5	25	38	13,25	HN	CL	1	20
1990A25/6	25	38	13,25	Al	CN	1	20
1990A32/0	32	47	15	HN	CN	1	20
1990A32/5	32	47	15	HN	CL	1	20
1990A32/6	32	47	15	Al	CN	1	20

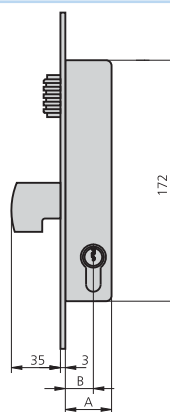

- Rodillo vaivén regulable y palanca
- Cilindro 5990/2525 o 5982/2525
- Cerradero CE1990/0

1990V20/0	20	33	13,25	HN	CN	1	20
1990V20/5	20	33	13,25	HN	CL	1	20
1990V20/6	20	33	13,25	Al	CN	1	20
1990V25/0	25	38	13,25	HN	CN	1	20
1990V25/5	25	38	13,25	HN	CL	1	20
1990V25/6	25	38	13,25	Al	CN	1	20
1990V32/0	32	47	15	HN	CN	1	20
1990V32/5	32	47	15	HN	CL	1	20
1990V32/6	32	47	15	Al	CN	1	20

PALANCA GANCHO ENTRE EJES 85 CILINDRO EUROPERFIL

SERIE 1994

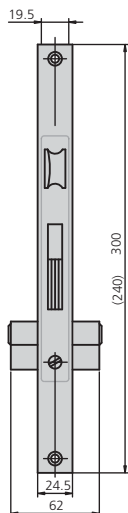

CARACTERÍSTICAS

- Frente de acero inoxidable
- Caja bicromatada
- Palanca basculante de gancho
- Picaporte reversible
- Cuadradillo de 8 mm
- Cilindro europerfil
- Tornillo de fijación de cilindro
- Cerradero según cerradura

ACCESORIOS OPCIONALES

- Gama completa de cilindros (ver páginas 119 - 140)

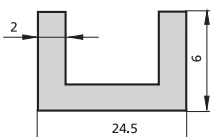

FRETE U

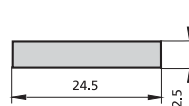

FRETE LISO

DESCRIPCIÓN	REF.	MEDIDAS		LEVA	ACABADOS		UDS	
		B	A		FRENTE	CILINDRO		

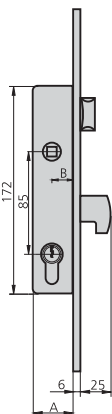

FRETE U

- Picaporte y palanca
- Cilindro 5982/2525/4
- Cerradero CE1994/6

Opciones cerraderos eléctricos

- CELC45/6A o CELC45/6AD

1994/25/6	18	33	15	AI	CN	1	10
1994/30/6	23	38	15	AI	CN	1	10
1994/35/6	28	43	15	AI	CN	1	10

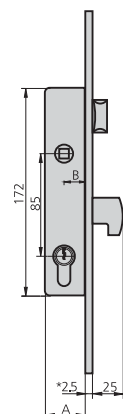

FRETE LISO

- Picaporte y palanca
- Cilindro 5982/2525/4
- Cilindro CE1994/6



Opciones cerraderos eléctricos

- CELC45/6A o CELC45/6AD

1994/25/6L	22	37	15	AI	CN	1	20
1994/30/6L	27	42	15	AI	CN	1	20
1994/35/6L	32	47	15	AI	CN	1	20

PALANCA GANCHO ENTRE EJES 85 CILINDRO EUROPERFIL

SERIE 1994

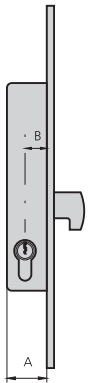
DESCRIPCIÓN	REF.	MEDIDAS		LEVA	ACABADOS		UDS	
		B	A		FRENTE	CILINDRO		
 <p>FRENTE U</p> <ul style="list-style-type: none"> Sólo palanca Cilindro 5982/2525/4 Cerradero CE1994/6 	1994A25/6	18	33	15	Al	CN	1	10
	1994A30/6	23	38	15	Al	CN	1	10
	1994A35/6	28	43	15	Al	CN	1	10
<p>FRENTE LISO</p> <ul style="list-style-type: none"> Sólo palanca Cilindro 5982/2525/4 Cerradero CE1994/6 	1994A25/6L	22	37	15	Al	CN	1	20
	1994A30/6L	27	42	15	Al	CN	1	20
	1994A35/6L	32	47	15	Al	CN	1	20

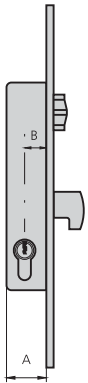
 <p>FRENTE U</p> <ul style="list-style-type: none"> Rodillo vaivén regulable y palanca Cilindro 5982/2525/4 Cerradero CE1994/6 	1994V25/6	18	33	15	Al	CN	1	10
	1994V30/6	23	38	15	Al	CN	1	10
	1994V35/6	28	43	15	Al	CN	1	10
<p>FRENTE LISO</p> <ul style="list-style-type: none"> Rodillo vaivén regulable y palanca Cilindro 5982/2525/4 Cerradero CE1994/6 	1994V25/6L	22	37	15	Al	CN	1	20
	1994V30/6L	27	42	15	Al	CN	1	20
	1994V35/6L	32	47	15	Al	CN	1	20

CARPINTERÍA METÁLICA

MULTIPUNTO PALANCA GANCHO ENTRE EJES 85

SERIE 2994

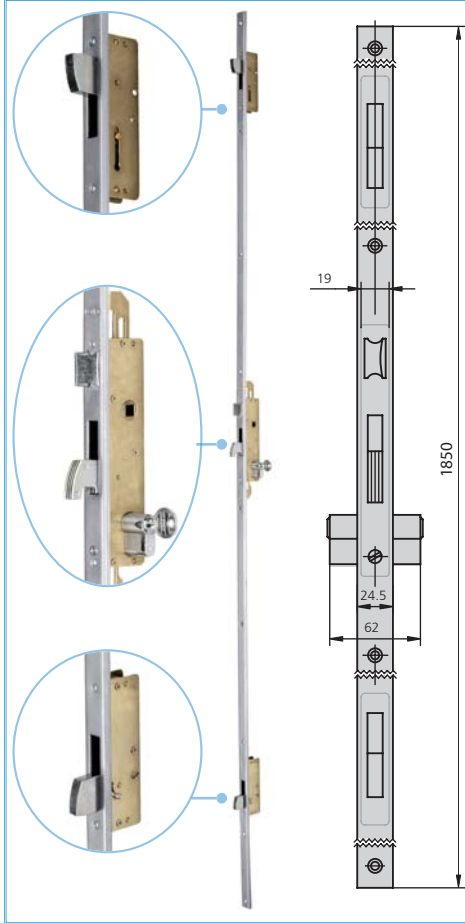

CARACTERÍSTICAS

- Frente de acero inoxidable
- Caja bicromatada
- Palanca basculante de gancho
- Picaporte reversible
- Cuadradillo de 8 mm
- Cilindro euoperfil de seguridad
- Tornillo de fijación de cilindro
- Cerradero según cerradura
- Escudo de seguridad BT194/1N

ACCESORIOS OPCIONALES

- Gama completa de cilindros (ver páginas 119 - 140)

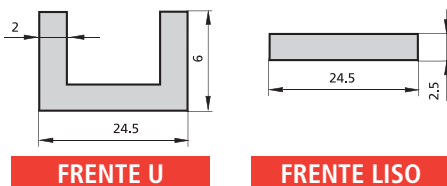

DESCRIPCIÓN	REF.	MEDIDAS		LEVA	ACABADOS		UDS	
		B	A		FRENTE	CILINDRO		

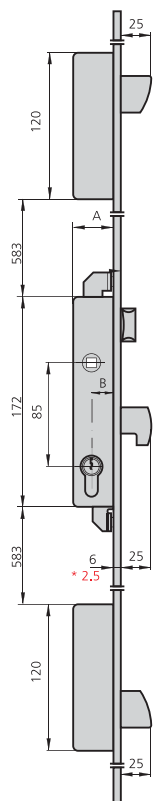

- FRENTE U**
- Picaporte y palanca
 - Cilindro 6982/2525/4
 - Cerradero CE1994/6
 - Cerradero alto/bajo CE2994S/6
 - Escudo de seguridad BT194/1N

2994/25/6	18	33	15	AI	CN	1	
2994/30/6	23	38	15	AI	CN	1	
2994/35/6	28	43	15	AI	CN	1	



- FRENTE LISO**
- Picaporte y palanca
 - Cilindro 6982/2525/4
 - Cerradero CE1994/6
 - Cerradero alto/bajo CE2994S/6
 - Escudo de seguridad BT194/1N

2994/25/6L	22	37	15	AI	CN	1	
2994/30/6L	27	42	15	AI	CN	1	
2994/35/6L	32	47	15	AI	CN	1	

* Medidas en frente liso

MULTIPUNTO PALANCA GANCHO ENTRE EJES 85

SERIE 2994

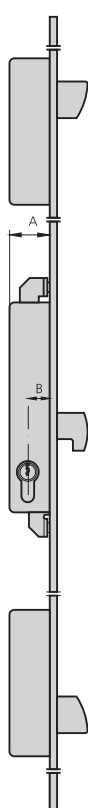
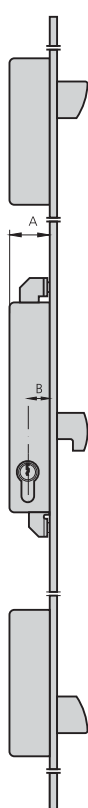
DESCRIPCIÓN	REF.	MEDIDAS		LEVA	ACABADOS		UDS	
		B	A		FRENTE	CILINDRO		
 <p>FRENTE U</p> <ul style="list-style-type: none"> Sólo palanca Cilindro 6982/2525/4 Cerradero CE1994/6 Cerradero alto/bajo CE2994S/6 Escudo de seguridad BT194/1N 	2994A25/6	18	33	15	Al	CN	1	
	2994A30/6	23	38	15	Al	CN	1	
	2994A35/6	28	43	15	Al	CN	1	
 <p>FRENTE LISO</p> <ul style="list-style-type: none"> Sólo palanca Cilindro 6982/2525/4 Cerradero CE1994/6 Cerradero alto/bajo CE2994S/6 Escudo de seguridad BT194/1N 	2994A25/6L	22	37	15	Al	CN	1	
	2994A30/6L	27	42	15	Al	CN	1	
	2994A35/6L	32	47	15	Al	CN	1	

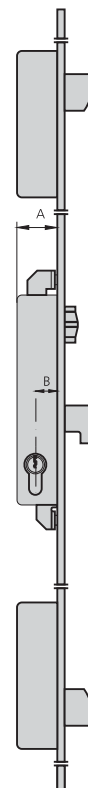
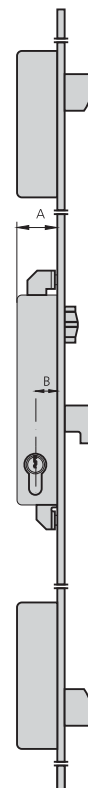
 <p>FRENTE U</p> <ul style="list-style-type: none"> Rodillo vaivén regulable y palanca Cilindro 6982/2525/4 Cerraderos CE1994/6 Cerraderos alto/bajo CE2994S/6 Escudo de seguridad BT194/1N 	2994V25/6	18	33	15	Al	CN	1	
	2994V30/6	23	38	15	Al	CN	1	
	2994V35/6	28	43	15	Al	CN	1	
 <p>FRENTE LISO</p> <ul style="list-style-type: none"> Rodillo vaivén regulable y palanca Cilindro 6982/2525/4 Cerraderos CE1994/6 Cerraderos alto/bajo CE2994S/6 Escudo de seguridad BT194/1N 	2994V25/6L	22	37	15	Al	CN	1	
	2994V30/6L	27	42	15	Al	CN	1	
	2994V35/6L	32	47	15	Al	CN	1	

MULTIPUNTO PALANCA GANCHO ENTRE EJES 85

SERIE 3994

CARPINTERÍA METÁLICA

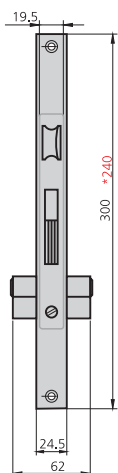

CARACTERÍSTICAS

- Cerradura de 3 puntos mediante barra roscada de M8
- Frente de acero inoxidable
- Caja bicromatada
- Palanca basculante de gancho
- Picaporte reversible
- Cuadradillo de 8 mm
- Cilindro de seguridad
- Tornillo de fijación de cilindro
- Cerradero según cerradura
- Escudo de seguridad ref. BT194/1N

ACCESORIOS OPCIONALES

- Gama completa de cilindros (ver páginas 119 - 140)

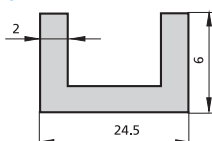

FRENTE U

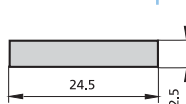

FRENTE LISO

* Medidas en frente liso

DESCRIPCIÓN	REF.	MEDIDAS		LEVA	ACABADOS		UDS	
		B	A		FRENTE	CILINDRO		

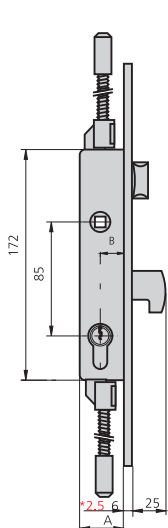

FRENTE U

- Picaporte y palanca
- Cilindro 6982/2525/4
- Cerradero CE1994/6
- Escudo de seguridad BT194/1N

3994/25/6	18	33	15	AI	CN	1	10
3994/30/6	23	38	15	AI	CN	1	10
3994/35/6	28	43	15	AI	CN	1	10

FRENTE LISO

- Picaporte y palanca
- Cilindro 6982/2525/4
- Cerradero CE1994/6
- Escudo de seguridad BT194/1N

3994/25/6L	22	37	15	AI	CN	1	10
3994/30/6L	27	42	15	AI	CN	1	10
3994/35/6L	32	47	15	AI	CN	1	10

* Medidas en frente liso

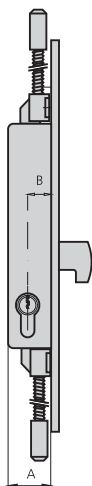

FRENTE U

- Sólo palanca
- Cilindro 6982/2525/4
- Cerradero CE1994/6
- Escudo de seguridad BT194/1N

3994A25/6	18	33	15	AI	CN	1	10
3994A30/6	23	38	15	AI	CN	1	10
3994A35/6	28	43	15	AI	CN	1	10

FRENTE LISO

- Sólo palanca
- Cilindro 6982/2525/4
- Cerradero CE1994/6
- Escudo de seguridad BT194/1N

3994A25/6L	22	37	15	AI	CN	1	10
3994A30/6L	27	42	15	AI	CN	1	10
3994A35/6L	32	47	15	AI	CN	1	10

MULTIPUNTO PALANCA GANCHO ENTRE EJES 85

SERIE 3994

DESCRIPCIÓN	REF.	MEDIDAS		LEVA	ACABADOS		UDS	
		B	A		FRENTE	CILINDRO		

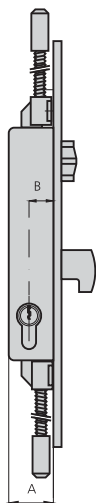

FRENTE U

- Rodillo vaivén regulable y palanca
- Cilindro 6982/2525/4
- Cerradero CE1994/6
- Escudo de seguridad BT194/1N

3994V25/6	18	33	15	Al	CN	1	10
3994V30/6	23	38	15	Al	CN	1	10
3994V35/6	28	43	15	Al	CN	1	10

FRENTE LISO

- Rodillo vaivén regulable y palanca
- Cilindro 6982/2525/4
- Cerradero CE1994/6
- Escudo de seguridad BT194/1N

3994V25/6L	22	37	15	Al	CN	1	10
3994V30/6L	27	42	15	Al	CN	1	10
3994V35/6L	32	47	15	Al	CN	1	10

FRENTE U

- Sin palanca y sin picaporte
- Cilindro 6982/2525/4
- Escudo de seguridad BT194/1N

3994F25/6	18	33	15	Al	CN	1	10
3994F30/6	23	38	15	Al	CN	1	10
3994F35/6	28	43	15	Al	CN	1	10

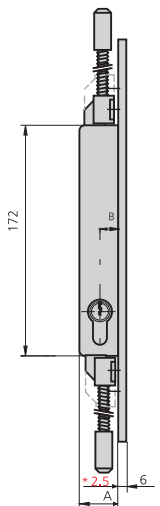

FRENTE LISO

- Sin palanca y sin picaporte
- Cilindro 6982/2525/4
- Escudo de seguridad BT194/1N

3994F25/6L	22	37	15	Al	CN	1	10
3994F30/6L	27	42	15	Al	CN	1	10
3994F35/6L	32	47	15	Al	CN	1	10

PALANCA DESLIZANTE ENTRE EJES 92 CILINDRO EUROPERFIL

SERIE 1992

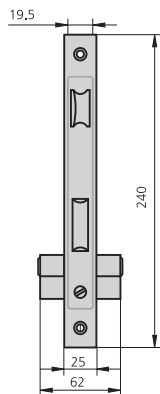

CARACTERÍSTICAS

- Frente de acero inoxidable
- Caja bicromatada
- Palanca deslizante
- Picaporte reversible
- Cuadradillo de 8 mm
- Cilindro europerfil
- 2 escudos de nylon ref. ES1984
- Tornillo de fijación de cilindro

ACCESORIOS OPCIONALES

- Cerraderos según cerradura (ver abajo)
- Gama completa de cilindros (ver páginas 119 - 140)

DESCRIPCIÓN	REF.	MEDIDAS		LEVA	ACABADOS		UDS	
		B	A		FRENTE	CILINDRO		

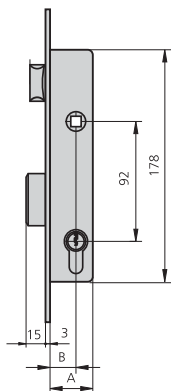

- Picaporte y palanca
- Cilindro 5990/2525

1992/20/6	20	33	13,25	Al	CN	1	20
1992/25/6	25	38	13,25	Al	CN	1	20
1992/30/6	30	43	13,25	Al	CN	1	20

Opciones de cerradero

- CE1984/6

Opciones cerraderos eléctricos

- CELC45/6A o CELC45 /6AD

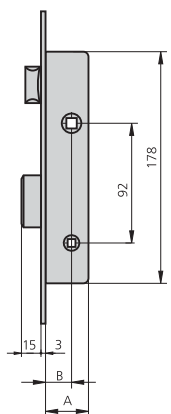

- Cerradura de condensa
- Sin cilindro

1992C20/6	20	33		Al		2	40
1992C25/6	25	38		Al		2	40
1992C30/6	30	43		Al		2	40

Opciones de cerradero

- CE1984/6

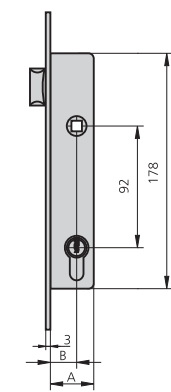

- Sólo picaporte
- Cilindro 55982T40/4

1992T20/6	20	33	15	Al	CN	1	20
1992T25/6	25	38	15	Al	CN	1	20
1992T30/6	30	43	15	Al	CN	1	20

Opciones cerraderos eléctricos

- CELC45T/6A o CELC45T/6AD

PALANCA DESLIZANTE ENTRE EJES 70 CILINDRO EUROPERFIL

SERIE 1983

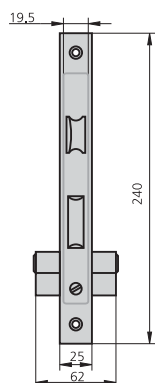

CARACTERÍSTICAS

- Frente hierro niquelado o acero inoxidable
- Caja bicromatada
- Palanca deslizante
- Picaporte reversible
- Cuadradillo de 8 mm
- Cilindro europerfil
- 2 escudos de nylon ref. ES1984
- Tornillo de fijación de cilindro

ACCESORIOS OPCIONALES

- Cerraderos según cerradura (ver abajo)
- Gama completa de cilindros (ver páginas 119 - 140)

CARPINTERÍA METÁLICA

DESCRIPCIÓN	REF.	MEDIDAS		LEVA	ACABADOS		UDS	
		B	A		FRENTE	CILINDRO		

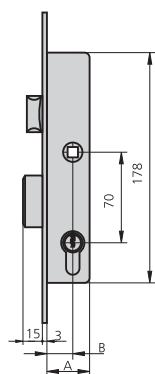

- Picaporte y palanca
- Cilindro 5990/2525

Opciones de cerradero

- CE1983/0 o CE1983/6

Opciones cerraderos eléctricos

- CELC45/6A o CELC45 /6AD

1983/20/0	20	33	13,25	HN	CN	1	20
1983/20/5	20	33	13,25	HN	CL	1	20
1983/20/6	20	33	13,25	AI	CN	1	20
1983/25/0	25	38	13,25	HN	CN	1	20
1983/25/5	25	38	13,25	HN	CL	1	20
1983/25/6	25	38	13,25	AI	CN	1	20
1983/30/0	30	43	13,25	HN	CN	1	20
1983/30/5	30	43	13,25	HN	CL	1	20
1983/30/6	30	43	13,25	AI	CN	1	20

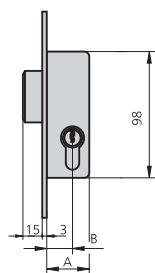

- Sólo palanca
- Cilindro 5990/2525

Opciones de cerradero

- CE2994S/6

1983A20/0	20	33	13,25	HN	CN	1	30
1983A20/5	20	33	13,25	HN	CL	1	30
1983A25/0	25	38	13,25	HN	CN	1	30
1983A25/5	25	38	13,25	HN	CL	1	30
1983A30/0	30	43	13,25	HN	CN	1	30
1983A30/5	30	43	13,25	HN	CL	1	30

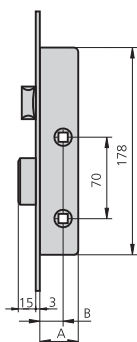

- Cerradura de condena
- Sin cilindro

Opciones de cerradero

- CE1983/6

1983C20/6	20	33		AI		2	40
1983C25/6	25	38		AI		2	40
1983C30/6	30	43		AI		2	40

PALANCA DESLIZANTE ENTRE EJES 70 CILINDRO EUROPERFIL

SERIE 1983

CARPINTERÍA METÁLICA

DESCRIPCIÓN	REF.	MEDIDAS		LEVA	ACABADOS		UDS	
		B	A		FRENTE	CILINDRO		
<ul style="list-style-type: none"> • Cerradura de sólo picaporte • Sin cilindro 	1983R20/0	20	33		HN		2	60
	1983R25/0	25	38		HN		2	60
	1983R30/0	30	43		HN		2	60

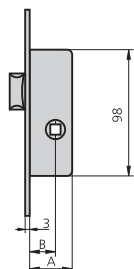

<ul style="list-style-type: none"> • Cerradura de sólo vaivén • Sin cilindro 	1983RV/0		33		HN		2	60
--	----------	--	----	--	----	--	---	----

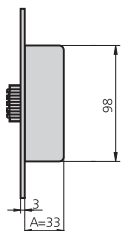

<ul style="list-style-type: none"> • Sólo picaporte • Cilindro 5982T40/4 	1983T20/6	20	33	15	AI	CN	1	20
	1983T25/6	25	38	15	AI	CN	1	20
	1983T30/6	30	43	15	AI	CN	1	20

Opciones de cerraderos eléctricos

- CELC45T/6A o CELC45T/6AD

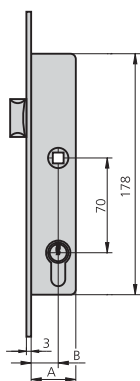

PALANCA DESLIZANTE ENTRE EJES 85 CILINDRO OVALADO MONOBLOCK

SERIE 1963

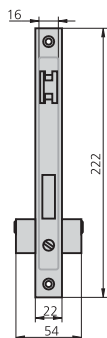

CARACTERÍSTICAS

- Frente de hierro niquelado o acero inoxidable
- Caja bicromatada
- Palanca deslizante
- Picaporte reversible
- Cuadradillo de 8 mm
- Cilindro ovalado monoblock (5963)
- 2 escudos de nylon ref. ES1963
- Tornillo de fijación de cilindro

ACCESORIOS OPCIONALES

- Cerraderos según cerradura (ver abajo)
- Cilindros (ver página 134)

CARPINTERÍA METÁLICA

DESCRIPCIÓN	REF.	MEDIDAS		LEVA	ACABADOS		UDS	
		B	A		FRENTE	CILINDRO		

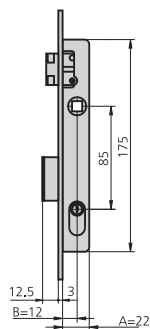

- Picaporte y palanca
- Cilindro 5963/2222

- Opciones de cerradero**
- CE1984/0 o CE1984/6

1963/0	12	22	HN	CN	1	20
1963/5	12	22	HN	CL	1	20
1963/6	12	22	AI	CN	1	20

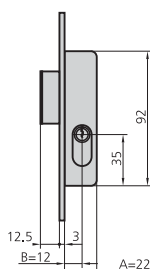

- Cerradura de sólo palanca
- Cilindro 5963/2222

- Opciones de cerradero**
- CE2994S/6

1963A/0	12	22	HN	CN	1	30
1963A/5	12	22	HN	CL	1	30
1963A/6	12	22	AI	CN	1	30

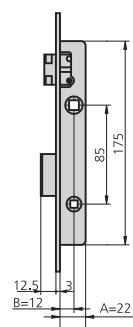

- Cerradura de condena
- Sin cilindro

- Opciones de cerradero**
- CE1984/6

1963C/6	12	22	AI		2	40
---------	----	----	----	--	---	----

PALANCA DESLIZANTE ENTRE EJES 85 CILINDRO OVALADO MONOBLOCK

SERIE 1963

CARPINTERÍA METÁLICA

DESCRIPCIÓN	REF.	MEDIDAS		LEVA	ACABADOS		UDS	
		B	A		FRENTE	CILINDRO		
<ul style="list-style-type: none"> • Cerradura de pomo condena • Sin cilindro <p>Opciones de cerradero</p> <ul style="list-style-type: none"> • CE1984/6 	1963CP16/6	12	22		Al		1	20
<ul style="list-style-type: none"> • Cerradura de sólo picaporte • Sin cilindro <p>Opciones de cerradero</p> <ul style="list-style-type: none"> • CE196R/6L 	1963R/0	12	22		HN		2	60
<ul style="list-style-type: none"> • Cerradura de sólo vaivén • Sin cilindro <p>Opciones de cerradero</p> <ul style="list-style-type: none"> • CE196R/6L 	1963RV/0		22		HN		2	60
<ul style="list-style-type: none"> • Rodillo vaivén regulable y palanca • Cilindro 5963/2222 <p>Opciones de cerradero</p> <ul style="list-style-type: none"> • CE1984/0 o CE1984/6 	1963V/0	12	22		HN	CN	1	20
	1963V/5	12	22		HN	CL	1	20
	1963V/6	12	22		Al	CN	1	20

PALANCA DESLIZANTE ENTRE EJES 85 CILINDRO OVALADO MONOBLOCK

SERIE 1975

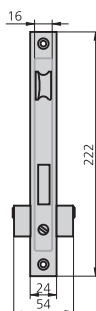

CARACTERÍSTICAS

- Frente de hierro niquelado
- Caja bicromatada
- Palanca deslizante
- Picaporte reversible
- Cuadradillo de 8 mm
- Cilindro ovalado monoblock (5963)
- 2 escudos de nylon ref. ES1963
- Tornillo de fijación de cilindro

ACCESORIOS OPCIONALES

- Cerraderos según cerradura (ver abajo)
- Cilindros (ver página 134)

CARPINTERÍA METÁLICA

DESCRIPCIÓN	REF.	MEDIDAS		LEVA	ACABADOS		UDS	
		B	A		FRENTE	CILINDRO		

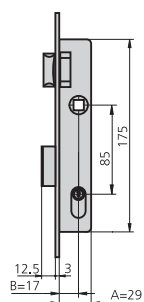

- Picaporte y palanca
- Cilindro 5963/2222

1975/0	17	29	HN	CN	1	20
1975/5	17	29	HN	CL	1	20

- Opciones de cerradero**
- CE1984/0

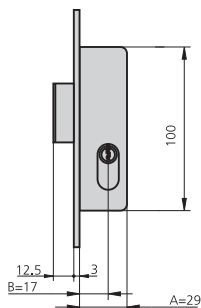

- Sólo palanca
- Cilindro 5963/2222

1975A/0	17	29	HN	CN	1	30
1975A/5	17	29	HN	CL	1	30

- Opciones de cerradero**
- CE2994S/6

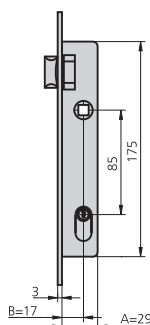

- Sólo picaporte
- Cilindro 5963T36

1975T/0	17	29	HN	CN	1	20
1975T/5	17	29	HN	CL	1	20

- Opciones de cerradero**
- CEC41T/6A o CEC41T/6AD

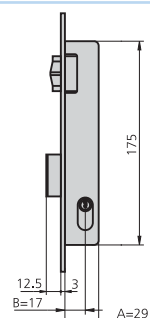

- Rodillo vaivén regulable y palanca
- Cilindro 5963/2222

1975V/0	17	29	HN	CN	1	20
1975V/5	17	29	HN	CL	1	20

- Opciones de cerradero**
- CE1984/0

PALANCA DESLIZANTE ENTRE EJES 74 CILINDRO OVALADO DE VÁSTAGOS

SERIES 1964

CARPINTERÍA METÁLICA

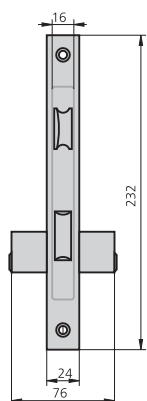

CARACTERÍSTICAS

- Frente de hierro niquelado o acero inoxidable
- Caja bicromatada
- Palanca deslizante
- Picaporte reversible
- Cuadradillo de 8 mm
- Cilindro ovalado monoblock (5964)
- 2 escudos de nylon ref. ES1964
- Tornillo de fijación de cilindro

ACCESORIOS OPCIONALES

- Cerraderos según cerradura (ver abajo)
- Cilindros (ver página 138)

DESCRIPCIÓN	REF.	MEDIDAS		LEVA	ACABADOS		UDS	
		B	A		FRENTE	CILINDRO		
<ul style="list-style-type: none"> • Picaporte y palanca • Cilindro ovalado 5964/2525 <p>Opciones de cerradero</p> <ul style="list-style-type: none"> • CE1984/0 o CE1984/6 	1964/0	20	34	HN	CN	1	20	
	1964/5	20	34	HN	CL	1	20	
	1964/6	20	34	AI	CN	1	20	
<ul style="list-style-type: none"> • Cerradura de sólo palanca • Cilindro ovalado 5964/2525 <p>Opciones de cerradero</p> <ul style="list-style-type: none"> • CE2994S/6 	1964A/0	20	34	HN	CN	1	30	
	1964A/5	20	34	HN	CL	1	30	
<ul style="list-style-type: none"> • Cerradura de condena • Sin cilindro <p>Opciones de cerradero</p> <ul style="list-style-type: none"> • CE1984/0 o CE1984/6 	1964C/0	20	34	HN		2	40	
	1964C/6	20	34	AI		2	40	
<ul style="list-style-type: none"> • Cerradura de pomo condena • Sin cilindro <p>Opciones de cerradero</p> <ul style="list-style-type: none"> • CE1984/6 	1964CP/6	20	34	AI		1	20	

PALANCA DESLIZANTE ENTRE EJES 74 CILINDRO OVALADO DE VÁSTAGOS **SERIES 1964**

DESCRIPCIÓN	REF.	MEDIDAS		LEVA	ACABADOS		UDS	
		B	A		FRENTE	CILINDRO		
<ul style="list-style-type: none"> • Cerradura de sólo picaporte • Sin cilindro <p>Opciones de cerradero</p> <ul style="list-style-type: none"> • CE196R/6L 	1964R/0	20	34		HN		2	60
<ul style="list-style-type: none"> • Cerradura de sólo vaivén • Sin cilindro <p>Opciones de cerradero</p> <ul style="list-style-type: none"> • CE196R/6L 	1964RV/0		34		HN		2	60
<ul style="list-style-type: none"> • Cerradura de sólo picaporte • Cilindro 5964T25 <p>Opciones de cerraderos eléctricos</p> <ul style="list-style-type: none"> • CEC41T/6A o CEC41T/6AD 	1964T/0 1964T/5 1964T/6	20 20 20	34 34 34		HN HN AI	CN CL CN	1 1 1	20 20 20
<ul style="list-style-type: none"> • Rodillo vaivén regulable y palanca • Cilindro 5964/2525 <p>Opciones de cerradero</p> <ul style="list-style-type: none"> • CE1984/0 o CE1984/6 	1964V/0 1964V/5 1964V/6	20 20 20	34 34 34		HN HN AI	CN CL CN	1 1 1	20 20 20

CARPINTERÍA METÁLICA

CERRADURA PARA PUERTAS DE ZÓCALO CON CILINDRO OVALADO DE VÁSTAGOS

SERIE 1981

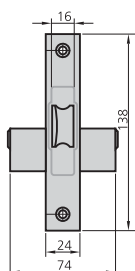

CARACTERÍSTICAS

- Frente de hierro niquelado
- Caja bicromatada
- Picaporte extensible y reversible
- Accionamiento extensible con llave
- Accionamiento del picaporte con llave y manilla
- Cuadradillo de 8 mm
- Cilindro ovalado monoblock (5081) o cilindro redondo monoblock (5181)
- 2 escudos de nylon ref. ES1964 ó ES1962/4
- Tornillo de fijación de cilindro
- Cerradero CE1991/0

ACCESORIOS OPCIONALES

- Cilindro (ver página 135)

DESCRIPCIÓN	REF.	MEDIDAS		LEVA	ACABADOS		UDS	
		B	A		FRENTE	CILINDRO		
CILINDRO OVALADO <ul style="list-style-type: none"> • Cilindro ovalado 5081/3030 • Cerradero CE1991/0 • Escudo de nylon ES1964 	1981/60/0	57	152		HN	CN	1	20
	1981/60/5	57	152		HN	CL	1	20
CILINDRO REDONDO <ul style="list-style-type: none"> • Cilindro redondo 5181/3030 • Cerradero CE1991/0 • Escudo ES1962/4 	11981/60/0	57	152		HN	CN	1	20
	11981/60/5	57	152		HN	CL	1	20
CILINDRO OVALADO <ul style="list-style-type: none"> • Vaivén extensible • Cilindro ovalado 5081/3030 • Cerradero CE1991/0 • Escudo de nylon ES1964 	1981V60/0	57	152		HN	CN	1	20
	1981V60/5	57	152		HN	CL	1	20
CILINDRO REDONDO <ul style="list-style-type: none"> • Vaivén extensible • Cilindro redondo 5181/3030 • Cerradero CE1991/0 • Escudo ES1962/4 	11981V60/0	57	152		HN	CN	1	20
	11981V60/5	57	152		HN	CL	1	20

CERRADURA PARA PUERTAS DE ZÓCALO CON CILINDRO EUROPERFIL

SERIE 1991

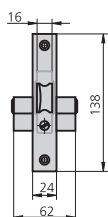

CARACTERÍSTICAS

- Frente de hierro niquelado
- Caja bicromatada
- Picaporte extensible y reversible
- Accionamiento extensible con llave
- Accionamiento del picaporte con llave y manilla
- Cuadradillo de 8 mm
- Cilindro europerfil
- 2 escudos de nylon ref. E51984
- Tornillo de fijación de cilindro
- Cerradero CE1991/0

ACCESORIOS OPCIONALES

- Gama completa de cilindros (ver páginas 119 - 140)

CARPINTERÍA METÁLICA

DESCRIPCIÓN	REF.	MEDIDAS		LEVA	ACABADOS		UDS	
		B	A		FRENTE	CILINDRO		
• Picaporte extensible y reversible	1991/60/0	58	149	15	HN	CN	1	20
• Cilindro europerfil 5982/2525	1991/60/5	58	149	15	HN	CL	1	20
• Cerradero CE1991/0	1991/70/0	68	159	15	HN	CN	1	20
	1991/70/5	68	159	15	HN	CL	1	20

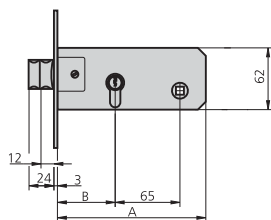

CERRADURA DE SÓLO GANCHO CON CILINDRO OVALADO DE VÁSTAGOS

SERIE 1968

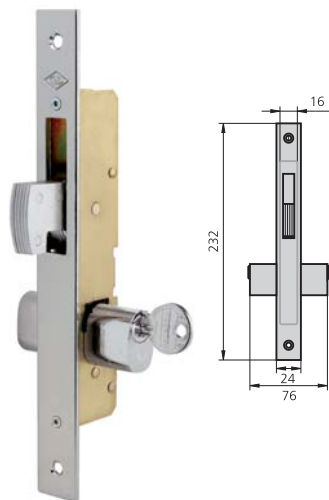

CARACTERÍSTICAS

- Frente de hierro niquelado
- Caja bicromatada
- Palanca de gancho
- Cilindro ovalado monoblock de vástagos
- 2 escudos de nylon ref. ES1964
- Tornillo de fijación de cilindro

ACCESORIOS OPCIONALES



DESCRIPCIÓN	REF.	MEDIDAS		LEVA	ACABADOS		UDS	
		B	A		FRENTE	CILINDRO		
<ul style="list-style-type: none"> • Cerradura con palanca basculante de gancho • Cilindro 5968/2525 	1968/0	17	34		HN	CN	1	20
	1968/5	17	34		HN	CL	1	20

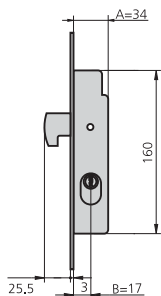

CERRADURA DE SÓLO GANCHO CON CILINDRO EUROPERFIL

SERIE 1982

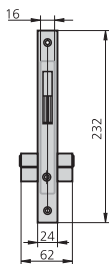

CARACTERÍSTICAS

- Frente de hierro niquelado
- Caja bicromatada
- Palanca de gancho
- Cilindro europerfil
- 2 escudos de nylon ref. E51984
- Tornillo de fijación de cilindro

ACCESORIOS OPCIONALES

- Gama completa de cilindros (ver páginas 119 - 140)

CARPINTERÍA METÁLICA

DESCRIPCIÓN	REF.	MEDIDAS		LEVA	ACABADOS		UDS	
		B	A		FRENTE	CILINDRO		
<ul style="list-style-type: none"> • Cerradura con palanca basculante de gancho • Cilindro 5982/2525 	1982/0	17	34		HN	CN	1	20
	1982/5	17	34		HN	CL	1	20

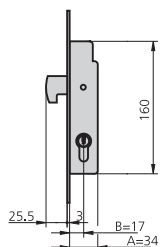

CERRADURA DE SÓLO PICAPORTE PARA PUERTAS METÁLICAS

SERIE 1979

CARACTERÍSTICAS

ACCESORIOS OPCIONALES

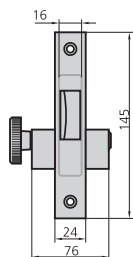

- Frente de hierro niquelado
- Caja bicromatada
- Picaporte reversible accionado con llave por el exterior y con pomo por el interior o accionamiento con llave por ambos lados
- Cilindro ovalado monoblock de vástagos
- 2 escudos de nylon ref. E51964
- Tornillo de fijación de cilindro

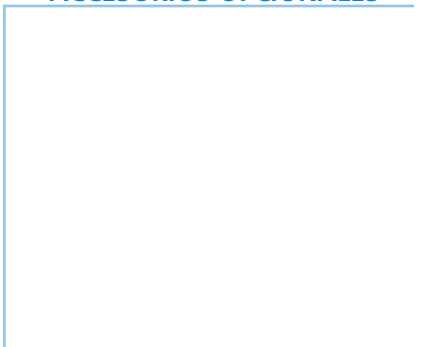

DESCRIPCIÓN	REF.	MEDIDAS		LEVA	ACABADOS		UDS	
		B	A		FRENTE	CILINDRO		

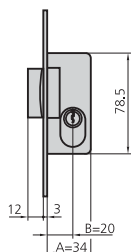

- Picaporte reversible accionado con llave por el exterior y pomo por el interior
- 5979P3030

1979P/0	20	34	HN	CN	1	30
1979P/5	20	34	HN	CL	1	30

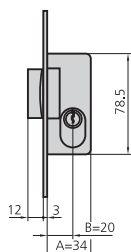

- Picaporte reversible accionado con llave por el exterior y por el interior
- 5979/3030

1979/0	20	34	HN	CN	1	30
1979/5	20	34	HN	CL	1	30

CERRADURA PARA PUERTAS Y PERSIANAS METÁLICAS ENROLLABLES

SERIE 11A

CARPINTERÍA METÁLICA



CARACTERÍSTICAS

- Cerradura para puertas metálicas enrollables
- Accionamiento exterior e interior mediante llave
- Caja bicromatada
- Cilindro redondo de 3 pitones

ACCESORIOS OPCIONALES

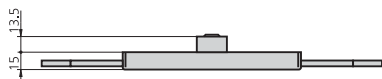

DESCRIPCIÓN	REF.	MEDIDAS		LEVA	ACABADOS		UDS	
		B	A		FRENTE	CILINDRO		
<ul style="list-style-type: none"> • Dos puntos de cierre laterales 	11A	60	154		CL		1	24
<ul style="list-style-type: none"> • Dos puntos de cierre laterales y un punto inferior 	11A/3P	60	154		CL		1	

CERRADURA PARA PUERTAS Y PERSIANAS METÁLICAS ENROLLABLES

SERIE 11E

CARACTERÍSTICAS

- Cerradura para persiana metálica enrollable
- Accionamiento exterior e interior mediante llave
- Cilindro redondo de 3 pitones

ACCESORIOS OPCIONALES

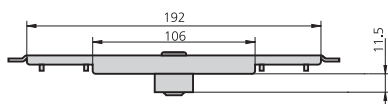

DESCRIPCIÓN	REF.	MEDIDAS		LEVA	ACABADOS		UDS	
		B	A		FRENTE	CILINDRO		
• Dos puntos de cierre horizontales	11E	30	216		CL		1	20

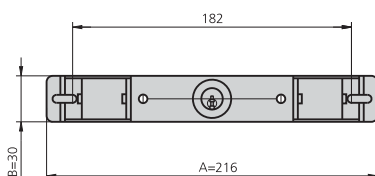

CERRADURA PARA PUERTAS METÁLICAS BASCULANTES

SERIE 11B

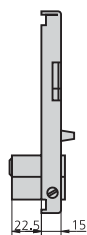

CARACTERÍSTICAS

- Accionamiento mediante manilla.
- Bloqueo interior mediante botón, bloqueo exterior mediante llave
- 2 puntos de cierre horizontales
- Caja bicromatada
- Medio cilindro monoblock ref. 5982T40/3
- Opcionalmente con set de escudo y manillas (ref. 11B/M)
- 1 Escudo ref. ES1960

ACCESORIOS OPCIONALES

- Gama completa de cilindros (ver páginas 119 - 140)

CARPINTERÍA METÁLICA

DESCRIPCIÓN	REF.	MEDIDAS		LEVA	ACABADOS		UDS	
		B	A		FRENTE	CILINDRO		
• Dos puntos de cierre horizontales	11B	60	154	15	CL		1	40
• Medio cilindro monoblock 5982T40/3	11B/M	60	154	15	CL		1	40

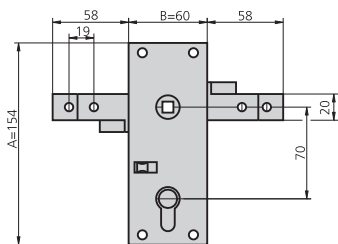

ACCESORIOS

CERRADEROS PARA CERRADURAS METÁLICAS

CARPINTERÍA METÁLICA

DESCRIPCIÓN	REF.	ACABADO	APLICABLE A CERRADURAS	UDS
-------------	------	---------	------------------------	-----

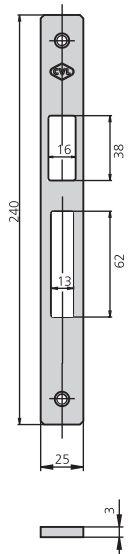

CE1983/0	HN	1983		
CE1983/6	AI			

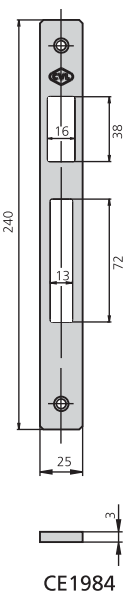

CE1984/0	HN	1984, 1992, 1995,		
CE1984/6	AI	1964, 1963, 1975		

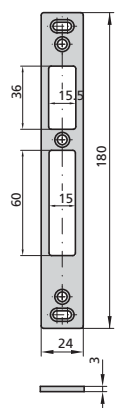

CE190/0	HN	190		
CE190/6	AI	190		

ACCESORIOS

CERRADEROS PARA CERRADURAS METÁLICAS

DESCRIPCIÓN	REF.	ACABADO	APLICABLE A CERRADURAS	UDS
-------------	------	---------	------------------------	-----

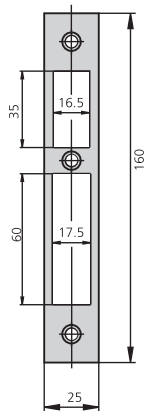

CE1990/0 HN 1990

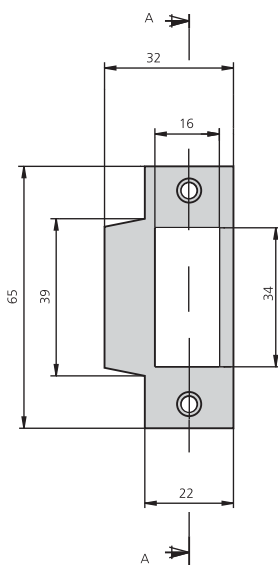

CE1991/0 HN 1991, 1981, 11981

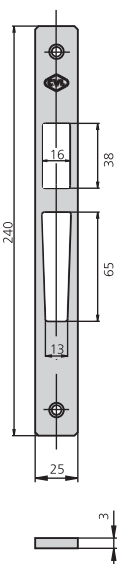

CE1994/6 Al 1994, 2994, 3994



ACCESORIOS

CERRADEROS PARA CERRADURAS METÁLICAS

CARPINTERÍA METÁLICA

DESCRIPCIÓN	REF.	ACABADO	APLICABLE A CERRADURAS	UDS
-------------	------	---------	------------------------	-----

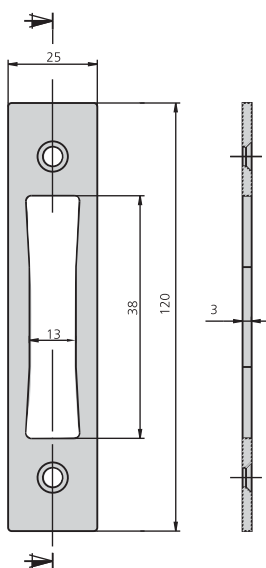

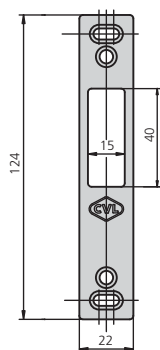

CE2994S/6 Al 1983A, 1963A, 1975A,
1995A, up/down 2994



CE196R/6 Al 1963R, 1964R, 1983R,
1995R

ACCESORIOS

CERRADEROS ELÉCTRICOS

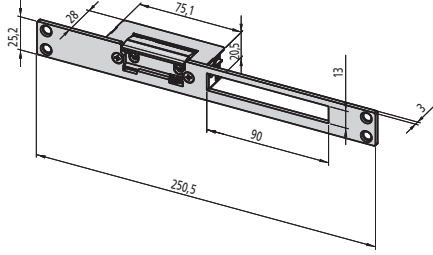
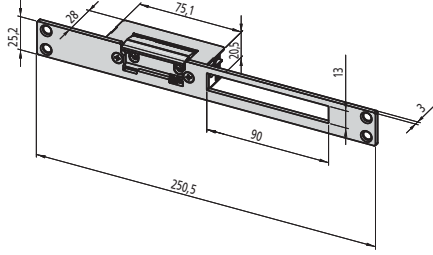
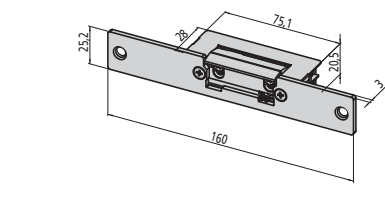
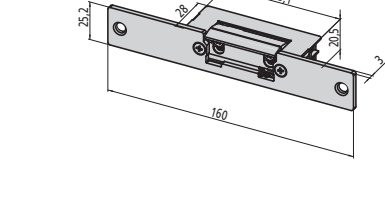
DESCRIPCIÓN	REF.	APLICABLE A CERRADURAS	UDS
<ul style="list-style-type: none"> • Cerradero eléctrico regulable reversible con funcionamiento automático • Frente plano inox • 12V / corriente alterna 	<p>CEL45/6A</p>	<p>1995, 1992, 1984, 190, 1990, 1994, 1983</p>	 
			
<ul style="list-style-type: none"> • Cerradero eléctrico regulable reversible con funcionamiento automático y con desbloqueo • Frente plano inox • 12V / corriente alterna 	<p>CEL45/6AD</p>	<p>1995, 1992, 1984, 190, 1990, 1994, 1983</p>	
			
<ul style="list-style-type: none"> • Cerradero eléctrico regulable reversible con funcionamiento automático • Sólo picaporte y frente plano inox • 12V / corriente alterna 	<p>CEL45T/6A</p>	<p>1995T, 1992T, 1983T, 1984T</p>	
			
<ul style="list-style-type: none"> • Cerradero eléctrico regulable reversible con funcionamiento automático y con desbloqueo • Sólo picaporte y frente plano inox • 12V / corriente alterna 	<p>CEL45T/6AD</p>	<p>1995T, 1992T, 1983T, 1984T</p>	
			

ACCESORIOS

ESCUDOS

DESCRIPCIÓN	REF.	ACABADO	APLICABLE A CERRADURAS	UDS
	ES1963	Escudo de nylon	1963, 1975	
	ES1964	Escudo de nylon	1964, 1968, 1979, 1981	
	ES1984	Escudo de nylon	1982, 1983, 1984, 1990, 1992, 1994, 1995, 196, 184, 183, 192, 194, 194, P194	

ACCESORIOS

ESCUDOS DE SEGURIDAD

DESCRIPCIÓN	REF.	ACABADO	APLICABLE A CERRADURAS	UDS
 <p>NEGRO</p>	BT194/1N	Negro	1983, 1984, 1990,	

CERRADURAS DE SOBREPONER

	Cerradura de sobreponer serie 56	90
	• Serie 56A	90
	• Serie 56B	91
	• Serie 56C	92
	Cerradura de sobreponer serie 125	93
	• Serie 125A	93
	• Serie 125B	94
	Cerradura de sobreponer serie 124	95
	• Serie 124A	95
	Cerradura de sobreponer serie 122	96
	• Serie 122A	96
	• Serie 122C	97
	Cerradura de sobreponer serie 123	98
	• Serie 123A	98
	• Serie 123C	99
	Cerrojos	100
	• Serie 1976	100
	• Serie 1978	101
	• Serie 1988	102
	Picaportes	103
	• Serie 234	103
	• Serie 236	104

CERRADURA DE SOBREPONER SERIE 56

SERIE 56A

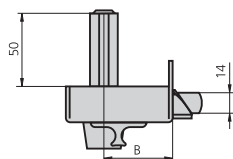

CARACTERÍSTICAS

- Picaporte accionado por llave exteriormente y con llave y tirador desde el interior
- Palanca de una vuelta de llave accionable por ambos lados
- Posibilidad de elección entre cilindro de perfil o cilindro redondo
- Dos acabados: hierro esmaltado y hierro niquelado
- Cerradero según cerradura
- Embellecedor según tipo de cilindro
- componentes de sujeción

ACCESORIOS OPCIONALES

- Cilindro de seguridad

DESCRIPCIÓN	REF.	MEDIDAS		CILINDRO	ACABADOS		UDS	
		B	A		FRENTE	CILINDRO		
• Cilindro perfil ref. 5056/50/3	56A60D/0	35	60	5056/50/3	HN	CL	1	24
• Cerradero ref. CE56AD o CE56AI	56A60I/0	35	60	5056/50/3	HN	CL	1	24
• Embellecedor ES125	56A60D/1	35	60	5056/50/3	HE	CL	1	24
	56A60I/1	35	60	5056/50/3	HE	CL	1	24
	56A70D/0	45	70	5056/50/3	HN	CL	1	24
Opciones cerraderos eléctricos	56A70I/0	45	70	5056/50/3	HN	CL	1	24
• CELC56/1A o CELC56/1BA	56A70D/1	45	70	5056/50/3	HE	CL	1	24
	56A70I/1	45	70	5056/50/3	HE	CL	1	24
	156A60D/0	35	60	5156/50/3	HN	CL	1	24
• Cilindro redondo ref. 5156/50/3	156A60I/0	35	60	5156/50/3	HN	CL	1	24
• Cerradero ref. CE56AD o CE56AI	156A60D/1	35	60	5156/50/3	HE	CL	1	24
• Embellecedor ES1125	156A60I/1	35	60	5156/50/3	HE	CL	1	24
	156A70D/0	45	70	5156/50/3	HN	CL	1	24
Opciones cerraderos eléctricos	156A70I/0	45	70	5156/50/3	HN	CL	1	24
• CELC56/1A o CELC56/1BA	156A70D/1	45	70	5156/50/3	HE	CL	1	24
	156A70I/1	45	70	5156/50/3	HE	CL	1	24

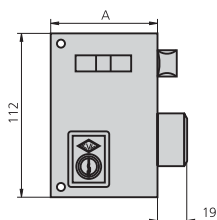

CERRADURA DE SOBREPONER SERIE 56 **SERIE 56B**

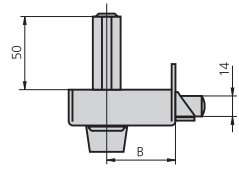

CARACTERÍSTICAS

- Picaporte accionado mediante manilla por ambos lados
- Palanca de una vuelta de llave accionable por ambos lados
- Posibilidad de elección entre cilindro de perfil o cilindro redondo
- Dos acabados: hierro esmaltado y hierro niquelado
- Cerradero según cerradura
- Embellecedor según tipo de cilindro
- Componentes de sujeción

ACCESORIOS OPCIONALES

- Cilindro de seguridad

DESCRIPCIÓN	REF.	MEDIDAS		CILINDRO	ACABADOS		UDS	
		B	A		FRENTE	CILINDRO		
• Cilindro perfil ref. 5056/50/3	56B60D/0	35	60	5056/50/3	HN	CL	1	24
	56B60I/0	35	60	5056/50/3	HN	CL	1	24
• Cerradero ref. CE56AD o CE56AI	56B60D/1	35	60	5056/50/3	HE	CL	1	24
• Embellecedor ES125	56B60I/1	35	60	5056/50/3	HE	CL	1	24
	56BR70D/0	45	70	5056/50/3	HN	CL	1	24
	56BR70I/0	45	70	5056/50/3	HN	CL	1	24
Opciones cerraderos eléctricos	56BR70D/1	45	70	5056/50/3	HE	CL	1	24
• CELC56/1A o CELC56/1BA	56BR70I/1	45	70	5056/50/3	HE	CL	1	24

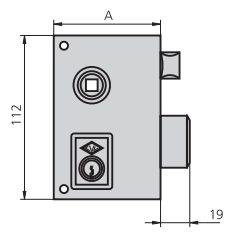

• Cilindro redondo ref. 5156/50/3	156B60D/0	35	60	5156/50/3	HN	CL	1	24
	156B60I/0	35	60	5156/50/3	HN	CL	1	24
• Cerradero ref. CE56AD o CE56AI	156B60D/1	35	60	5156/50/3	HE	CL	1	24
• Embellecedor ES1125	156B60I/1	35	60	5156/50/3	HE	CL	1	24
	156BR70D/0	45	70	5156/50/3	HN	CL	1	24
	156BR70I/0	45	70	5156/50/3	HN	CL	1	24
Opciones cerraderos eléctricos	156BR70D/1	45	70	5156/50/3	HE	CL	1	24
• CELC56/1A o CELC56/1BA	156BR70I/1	45	70	5156/50/3	HE	CL	1	24

CERRADURAS DE SOBREPONER

CERRADURA DE SOBREPONER SERIE 56

SERIE 56C

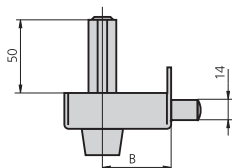

CARACTERÍSTICAS

- Picaporte accionado por manilla por ambos lados
- Palanca de una vuelta de llave accionable por ambos lados
- Posibilidad de elección entre cilindro de perfil o cilindro redondo
- Dos acabados: hierro esmaltado y hierro niquelado
- Cerradero según cerradura
- Embellecedor según tipo de cilindro
- componentes de sujeción

ACCESORIOS OPCIONALES

- Cilindro de seguridad

CERRADURAS DE SOBREPONER

DESCRIPCIÓN	REF.	MEDIDAS		CILINDRO	ACABADOS		UDS	
		B	A		FRENTE	CILINDRO		
• Cilindro perfil ref. 5056/50/3	56C60D/0	35	60	5056/50/3	HN	CL	1	24
	56C60I/0	35	60	5056/50/3	HN	CL	1	24
• Cerradero ref. CE56C/1 o CE56C/0	56C60D/1	35	60	5056/50/3	HE	CL	1	24
	56C60I/1	35	60	5056/50/3	HE	CL	1	24
• Embellecedor ES125	56C70D/0	45	70	5056/50/3	HN	CL	1	24
	56C70I/0	45	70	5056/50/3	HN	CL	1	24
	56C70D/1	45	70	5056/50/3	HE	CL	1	24
	56C70I/1	45	70	5056/50/3	HE	CL	1	24
• Cilindro redondo ref. 5156/50/3	156C60D/0	35	60	5156/50/3	HN	CL	1	24
	156C60I/0	35	60	5156/50/3	HN	CL	1	24
• Cerradero ref. CE56C/1 o CE56C/0	156C60D/1	35	60	5156/50/3	HE	CL	1	24
	156C60I/1	35	60	5156/50/3	HE	CL	1	24
• Embellecedor ES1125	156C70D/0	45	70	5156/50/3	HN	CL	1	24
	156C70I/0	45	70	5156/50/3	HN	CL	1	24
	156C70D/1	45	70	5156/50/3	HE	CL	1	24
	156C70I/1	45	70	5156/50/3	HE	CL	1	24

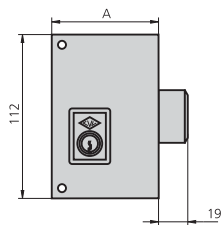

CERRADURA DE SOBREPONER SERIE 125

SERIE 125A

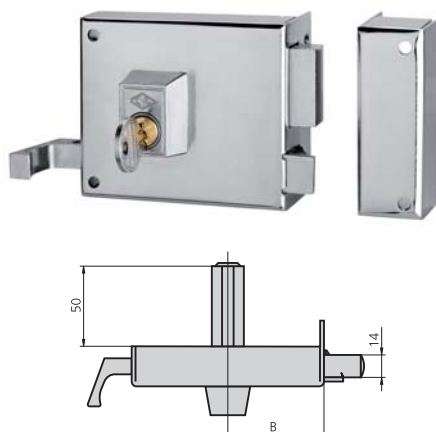

CARACTERÍSTICAS

- Picaporte accionado por llave exteriormente y con llave y tirador desde el interior
- Palanca de dos vueltas de llave accionable por ambos lados
- Posibilidad de elección entre cilindro de perfil o cilindro redondo
- Dos acabados: hierro esmaltado y hierro niquelado
- Cerradero según cerradura
- Embellecedor según tipo de cilindro
- Componentes de sujeción

ACCESORIOS OPCIONALES

- Cilindro de seguridad

DESCRIPCIÓN	REF.	MEDIDAS		CILINDRO	ACABADOS		UDS	
		B	A		FRENTE	CILINDRO		
• Cilindro perfil ref. 5056/50/3	125A8D/0	47	90	5056/50/3	HN	CL	1	20
• Picaporte reversible en la medida de 100 mm (REF. 125AR)	125A8I/0	47	90	5056/50/3	HN	CL	1	20
• Cerradero ref. CE125AD o CE125AI	125A8D/1	47	90	5056/50/3	HE	CL	1	20
• Embellecedor ES125	125A8I/1	47	90	5056/50/3	HE	CL	1	20
Opciones cerraderos eléctricos	125AR10D/0	60	100	5056/50/3	HN	CL	1	20
• CELC125/1A o CELC125/1BA	125AR10I/0	60	100	5056/50/3	HN	CL	1	20
	125AR10D/1	60	100	5056/50/3	HE	CL	1	20
	125AR10I/1	60	100	5056/50/3	HE	CL	1	20
	125A12D/0	60	120	5056/50/3	HN	CL	1	20
	125A12I/0	60	120	5056/50/3	HN	CL	1	20
	125A12D/1	60	120	5056/50/3	HE	CL	1	20
	125A12I/1	60	120	5056/50/3	HE	CL	1	20
	125A14D/0	70	140	5056/50/3	HN	CL	1	20
	125A14I/0	70	140	5056/50/3	HN	CL	1	20
	125A14D/1	70	140	5056/50/3	HE	CL	1	20
	125A14I/1	70	140	5056/50/3	HE	CL	1	20
	1125A8D/0	47	90	5156/50/3	HN	CL	1	20
	1125A8I/0	47	90	5156/50/3	HN	CL	1	20
	1125A8D/1	47	90	5156/50/3	HE	CL	1	20
	1125A8I/1	47	90	5156/50/3	HE	CL	1	20
	1125AR10D/0	60	100	5156/50/3	HN	CL	1	20
	1125AR10I/0	60	100	5156/50/3	HN	CL	1	20
	1125AR10D/1	60	100	5156/50/3	HE	CL	1	20
	1125AR10I/1	60	100	5156/50/3	HE	CL	1	20
	1125A12D/0	60	120	5156/50/3	HN	CL	1	20
	1125A12I/0	60	120	5156/50/3	HN	CL	1	20
	1125A12D/1	60	120	5156/50/3	HE	CL	1	20
	1125A12I/1	60	120	5156/50/3	HE	CL	1	20
	1125A14D/0	70	140	5156/50/3	HN	CL	1	20
	1125A14I/0	70	140	5156/50/3	HN	CL	1	20
	1125A14D/1	70	140	5156/50/3	HE	CL	1	20
	1125A14I/1	70	140	5156/50/3	HE	CL	1	20

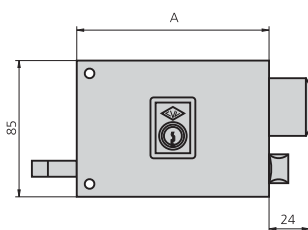

- Cilindro redondo ref. 5156/50/3
- Picaporte reversible en la medida de 100 mm (REF. 1125AR)
- Cerradero ref. CE125AD o CE125AI
- Embellecedor ES1125

Opciones cerraderos eléctricos

- CELC125/1A o CELC125/1BA

CERRADURA DE SOBREPONER SERIE 125

SERIE 125B

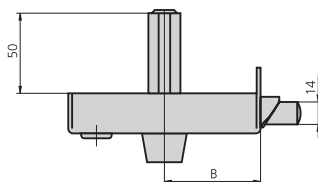

CARACTERÍSTICAS

- Picaporte accionado por manilla por ambos lados
- Picaporte reversible
- Palanca de dos vueltas de llave accionable por ambos lados
- Posibilidad de elección entre cilindro de perfil o cilindro redondo
- Dos acabados: hierro esmaltado y hierro niquelado
- Cerradero según cerradura
- Embellecedor según tipo de cilindro
- Componentes de sujeción

ACCESORIOS OPCIONALES

- Cilindro de seguridad

CERRADURAS DE SOBREPONER

DESCRIPCIÓN	REF.	MEDIDAS		CILINDRO	ACABADOS		UDS	
		B	A		FRENTE	CILINDRO		
• Cilindro perfil ref. 5056/50/3	125BR12D/0	60	120	5056/50/3	HN	CL	1	24
• Picaporte reversible	125BR12I/0	60	120	5056/50/3	HN	CL	1	24
• Cerradero ref. CE125AD o CE125AI	125BR12D/1	60	120	5056/50/3	HE	CL	1	24
• Embellecedor ES125	125BR12I/1	60	120	5056/50/3	HE	CL	1	24
Opciones cerraderos eléctricos	125BR14D/0	70	140	5056/50/3	HN	CL	1	24
• CELC125/1A o CELC125/1BA	125BR14I/0	70	140	5056/50/3	HN	CL	1	24
	125BR14D/1	70	140	5056/50/3	HE	CL	1	24
	125BR14I/1	70	140	5056/50/3	HE	CL	1	24

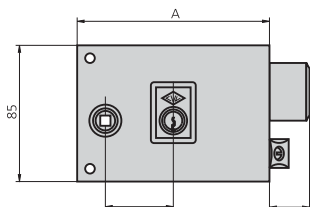

- Cilindro redondo ref. 5156/50/3
- Picaporte reversible
- Cerradero ref. CE125AD o CE125AI
- Embellecedor ES1125

- Opciones cerraderos eléctricos**
- CELC125/1A o CELC125/1BA

1125BR12D/0	60	120	5156/50/3	HN	CL	1	24
1125BR12I/0	60	120	5156/50/3	HN	CL	1	24
1125BR12D/1	60	120	5156/50/3	HE	CL	1	24
1125BR12I/1	60	120	5156/50/3	HE	CL	1	24
1125BR14D/0	70	140	5156/50/3	HN	CL	1	24
1125BR14I/0	70	140	5156/50/3	HN	CL	1	24
1125BR14D/1	70	140	5156/50/3	HE	CL	1	24
1125BR14I/1	70	140	5156/50/3	HE	CL	1	24

CERRADURA DE SOBREPONER SERIE 124

SERIE 124A



CARACTERÍSTICAS

- Palanca de dos vueltas de llave accionable por ambos lados
- Posibilidad de elección entre cilindro de perfil o cilindro redondo
- Dos acabados: hierro esmaltado y hierro niquelado
- Cerradero según cerradura
- Embellecedor según tipo de cilindro
- Componentes de sujeción

ACCESORIOS OPCIONALES

- Cilindro de seguridad

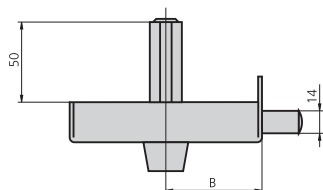

DESCRIPCIÓN	REF.	MEDIDAS		CILINDRO	ACABADOS		UDS	
		B	A		FRENTE	CILINDRO		
<ul style="list-style-type: none"> • Cilindro perfil ref. 5056/50/3 • Cerradero ref. CE125AD o CE125AI • Embellecedor ES125 	124A8D/0	47	90	5056/50/3	HN	CL	1	24
	124A8I/0	47	90	5056/50/3	HN	CL	1	24
	124A8D/1	47	90	5056/50/3	HE	CL	1	24
	124A8I/1	47	90	5056/50/3	HE	CL	1	24
	124A10D/0	60	100	5056/50/3	HN	CL	1	24
	124A10I/0	60	100	5056/50/3	HN	CL	1	24
	124A10D/1	60	100	5056/50/3	HE	CL	1	24
	124A10I/1	60	100	5056/50/3	HE	CL	1	24
	124A12D/0	60	120	5056/50/3	HN	CL	1	24
	124A12I/0	60	120	5056/50/3	HN	CL	1	24
	124A12D/1	60	120	5056/50/3	HE	CL	1	24
	124A12I/1	60	120	5056/50/3	HE	CL	1	24
	124A14D/0	70	140	5056/50/3	HN	CL	1	24
	124A14I/0	70	140	5056/50/3	HN	CL	1	24
124A14D/1	70	140	5056/50/3	HE	CL	1	24	
124A14I/1	70	140	5056/50/3	HE	CL	1	24	
<ul style="list-style-type: none"> • Cilindro redondo ref. 5156/50/3 • Cerradero ref. CE125AD o CE125AI • Embellecedor ES1125 	1124A8D/0	47	90	5156/50/3	HN	CL	1	24
	1124A8I/0	47	90	5156/50/3	HN	CL	1	24
	1124A8D/1	47	90	5156/50/3	HE	CL	1	24
	1124A8I/1	47	90	5156/50/3	HE	CL	1	24
	1124A10D/0	60	100	5156/50/3	HN	CL	1	24
	1124A10I/0	60	100	5156/50/3	HN	CL	1	24
	1124A10D/1	60	100	5156/50/3	HE	CL	1	24
	1124A10I/1	60	100	5156/50/3	HE	CL	1	24
	1124A12D/0	60	120	5156/50/3	HN	CL	1	24
	1124A12I/0	60	120	5156/50/3	HN	CL	1	24
	1124A12D/1	60	120	5156/50/3	HE	CL	1	24
	1124A12I/1	60	120	5156/50/3	HE	CL	1	24
	1124A14D/0	70	140	5156/50/3	HN	CL	1	24
	1124A14I/0	70	140	5156/50/3	HN	CL	1	24
1124A14D/1	70	140	5156/50/3	HE	CL	1	24	
1124A14I/1	70	140	5156/50/3	HE	CL	1	24	

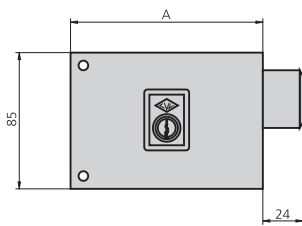

CERRADURAS DE SOBREPONER

CERRADURA DE SOBREPONER SERIE 122

SERIE 122A

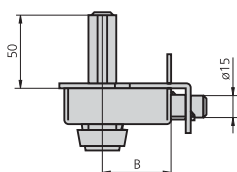

CARACTERÍSTICAS

- Cerradura de sobreponer reforzada
- Picaporte accionado por llave exteriormente y con llave o pomo desde el interior
- Palanca de 3 bulones de acero a dos vueltas de llave accionable por ambos lados del cilindro
- Sistema antipalanqueta
- Posibilidad de elección entre cilindro de perfil o cilindro redondo
- Dos acabados: hierro esmaltado y hierro niquelado
- Cerradero según cerradura
- Embellecedor según tipo de cilindro
- Componentes de sujeción

ACCESORIOS OPCIONALES

- Cilindro de seguridad

CERRADURAS DE SOBREPONER

DESCRIPCIÓN	REF.	MEDIDAS		CILINDRO	ACABADOS		UDS	
		B	A		FRENTE	CILINDRO		
<ul style="list-style-type: none"> • Cilindro perfil ref. 5056/50/3 • Cerradero ref. CE122AD o CE122AI • Embellecedor ES125 	122A70D/0	45	70	5056/50/3	HN	CL	1	10
	122A70I/0	45	70	5056/50/3	HN	CL	1	10
	122A70D/1	45	70	5056/50/3	HE	CL	1	10
	122A70I/1	45	70	5056/50/3	HE	CL	1	10
<ul style="list-style-type: none"> • Cilindro redondo ref. 5156/50/3 • Cerradero ref. CE122AD o CE122AI • Embellecedor ES1125 	1122A70D/0	45	70	5156/50/3	HN	CL	1	10
	1122A70I/0	45	70	5156/50/3	HN	CL	1	10
	1122A70D/1	45	70	5156/50/3	HE	CL	1	10
	1122A70I/1	45	70	5156/50/3	HE	CL	1	10

CERRADURA DE SOBREPONER SERIE 122 **SERIE 122C**

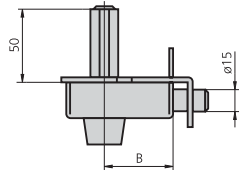

CARACTERÍSTICAS

- Cerradura de sobreponer reforzada
- Palanca de 4 bulones de acero a dos vueltas de llave accionable por ambos lados del cilindro
- Sistema antipalanqueta
- Posibilidad de elección entre cilindro de perfil o cilindro redondo
- Dos acabados: hierro esmaltado y hierro niquelado
- Cerradero según cerradura
- Embellecedor según tipo de cilindro
- Componentes de sujeción

ACCESORIOS OPCIONALES

- Cilindro de seguridad

DESCRIPCIÓN	REF.	MEDIDAS		CILINDRO	ACABADOS		UDS	
		B	A		FRENTE	CILINDRO		
<ul style="list-style-type: none"> • Cilindro perfil ref. 5056/50/3 • Cerradero ref. CE122C/1 o CE122C/0 • Embellecedor ES125 	122C70D/0	45	70	5056/50/3	HN	CL	1	10
	122C70I/0	45	70	5056/50/3	HN	CL	1	10
	122C70D/1	45	70	5056/50/3	HE	CL	1	10
	122C70I/1	45	70	5056/50/3	HE	CL	1	10
<ul style="list-style-type: none"> • Cilindro redondo ref. 5156/50/3 • Cerradero ref. CE122C/1 o CE122C/0 • Embellecedor ES1125 	1122C70D/0	45	70	5156/50/3	HN	CL	1	10
	1122C70I/0	45	70	5156/50/3	HN	CL	1	10
	1122C70D/1	45	70	5156/50/3	HE	CL	1	10
	1122C70I/1	45	70	5156/50/3	HE	CL	1	10

CERRADURAS DE SOBREPONER

CERRADURA DE SOBREPONER SERIE 123

SERIE 123A

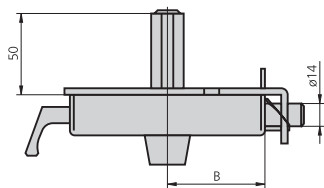

CARACTERÍSTICAS

- Cerradura de sobreponer reforzada
- Picaporte accionable mediante llave por el exterior y con tirador o llave desde el interior
- Palanca de 3 bulones de acero a dos vueltas de llave accionable por ambos lados del cilindro
- Sistema antipalanqueta
- Posibilidad de elección entre cilindro de perfil o cilindro redondo
- Dos acabados: hierro esmaltado y hierro niquelado
- Cerradero según cerradura
- Embellecedor según tipo de cilindro
- Componentes de sujeción

ACCESORIOS OPCIONALES

- Cilindro de seguridad

CERRADURAS DE SOBREPONER

DESCRIPCIÓN	REF.	MEDIDAS		CILINDRO	ACABADOS		UDS	
		B	A		FRENTE	CILINDRO		
• Cilindro perfil ref. 5056/50/3	123A10D/0	60	100	5056/50/3	HN	CL	1	10
• Cerradero ref. CE123AD o CE123AI	123A10I/0	60	100	5056/50/3	HN	CL	1	10
• Embellecedor ES125	123A10D/1	60	100	5056/50/3	HE	CL	1	10
	123A10I/1	60	100	5056/50/3	HE	CL	1	10
	123A12D/0	60	120	5056/50/3	HN	CL	1	10
	123A12I/0	60	120	5056/50/3	HN	CL	1	10
	123A12D/1	60	120	5056/50/3	HE	CL	1	10
	123A12I/1	60	120	5056/50/3	HE	CL	1	10

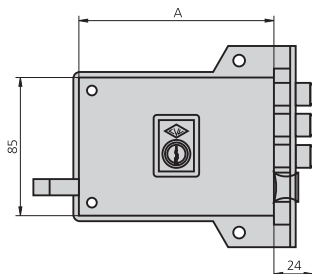

- Cilindro redondo ref. 5156/50/3
- Cerradero ref. CE123AD o CE123AI
- Embellecedor ES1125

	1123A10D/0	60	100	5156/50/3	HN	CL	1	10
	1123A10I/0	60	100	5156/50/3	HN	CL	1	10
	1123A10D/1	60	100	5156/50/3	HE	CL	1	10
	1123A10I/1	60	100	5156/50/3	HE	CL	1	10
	1123A12D/0	60	120	5156/50/3	HN	CL	1	10
	1123A12I/0	60	120	5156/50/3	HN	CL	1	10
	1123A12D/1	60	120	5156/50/3	HE	CL	1	10
	1123A12I/1	60	120	5156/50/3	HE	CL	1	10

CERRADURA DE SOBREPONER SERIE 123 **SERIE 123C**

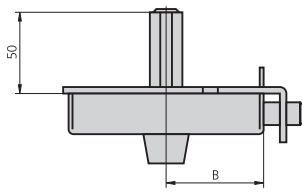

CARACTERÍSTICAS

- Cerradura de sobreponer reforzada
- Palanca de 4 bulones de acero a dos vueltas de llave accionable por ambos lados del cilindro
- Sistema antipalanqueta
- Posibilidad de elección entre cilindro de perfil o cilindro redondo
- Dos acabados: hierro esmaltado y hierro niquelado
- Cerradero según cerradura
- Embellecedor según tipo de cilindro
- Componentes de sujeción

ACCESORIOS OPCIONALES

- Cilindro de seguridad

DESCRIPCIÓN	REF.	MEDIDAS		CILINDRO	ACABADOS		UDS	
		B	A		FRENTE	CILINDRO		
• Cilindro perfil ref. 5056/50/3	123C10D/0	60	100	5056/50/3	HN	CL	1	10
• Cerradero ref. CE123C/1 o CE123C/1	123C10I/0	60	100	5056/50/3	HN	CL	1	10
• Embellecedor ES125	123C10D/1	60	100	5056/50/3	HE	CL	1	10
	123C10I/1	60	100	5056/50/3	HE	CL	1	10
	123C12D/0	60	120	5056/50/3	HN	CL	1	10
	123C12I/0	60	120	5056/50/3	HN	CL	1	10
	123C12D/1	60	120	5056/50/3	HE	CL	1	10
	123C12I/1	60	120	5056/50/3	HE	CL	1	10

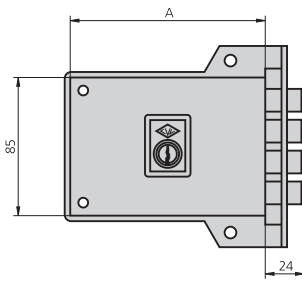

• Cilindro redondo ref. 5156/50/3	1123C10D/0	60	100	5156/50/3	HN	CL	1	10
• Cerradero ref. CE123C/1 o CE123C/1	1123C10I/0	60	100	5156/50/3	HN	CL	1	10
• Embellecedor ES1125	1123C10D/1	60	100	5156/50/3	HE	CL	1	10
	1123C10I/1	60	100	5156/50/3	HE	CL	1	10
	1123C12D/0	60	120	5156/50/3	HN	CL	1	10
	1123C12I/0	60	120	5156/50/3	HN	CL	1	10
	1123C12D/1	60	120	5156/50/3	HE	CL	1	10
	1123C12I/1	60	120	5156/50/3	HE	CL	1	10

CERRADURAS DE SOBREPONER

CERROJOS

SERIE 1976

CARACTERÍSTICAS

- Cerrojo de seguridad reversible aplicable a puertas metálicas basculantes o enrollables
- Se suministra por parejas con la misma llave
- Palanca deslizante de acero accionable por llave desde el exterior
- Cilindro exterior redondo diámetro 26 mm
- Acabado en hierro esmaltado

ACCESORIOS OPCIONALES

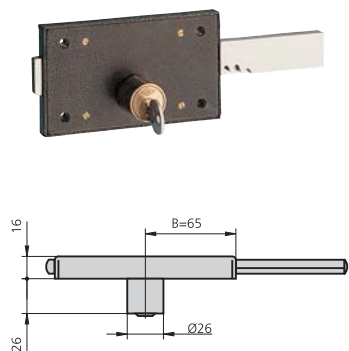

DESCRIPCIÓN

REF.

**MEDIDAS
B A**

**CILINDRO
Ø 26mm**

**ACABADOS
FRENTE CILINDRO**

UDS

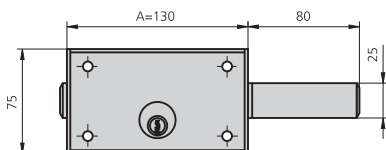

1976/1	65	130	Ø 26mm	HE	CL	1	17
--------	----	-----	--------	----	----	---	----

CERROJOS **SERIE 1978**

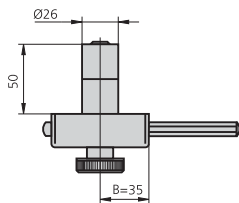

CARACTERÍSTICAS

- Cerrojo de seguridad reversible
- Palanca deslizante de acero accionable por llave desde el exterior y mediante pomo desde el interior
- Cilindro exterior redondo diámetro 26 mm
- Dos acabados: hierro esmaltado y hierro niquelado
- Cerradero CE1978/1 o CE1978/0
- Embellecedor ES1125
- Componentes de sujeción

ACCESORIOS OPCIONALES

- Cilindro de seguridad
- Cilindros de distintas larguras

DESCRIPCIÓN	REF.	MEDIDAS		CILINDRO		ACABADOS		UDS	
		B	A	FRENTE	CILINDRO				

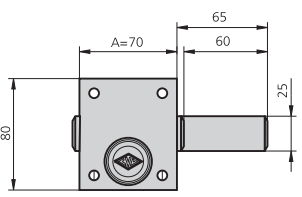

1978/0	35	70	Ø 26mm	HN	CL	1	20
1978/1	35	70	Ø 26mm	HE	CL	1	20

CERRADURAS DE SOBREPONER

CERROJOS

SERIE 1988

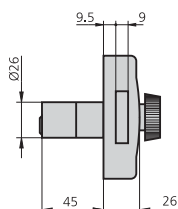

CARACTERÍSTICAS

- Cerrojo de seguridad reversible
- Palanca deslizante de acero accionable por llave desde el exterior y mediante pomo desde el interior
- Cilindro exterior redondo diámetro 26 mm
- Dos acabados: hierro esmaltado y hierro niquelado
- Cerradero CE1988/1 o CE1988/0
- Embellecedor ES1125
- Componentes de sujeción

ACCESORIOS OPCIONALES

- Cilindro de seguridad
- Cilindros de distintas longitudes

CERRADURAS DE SOBREPONER

DESCRIPCIÓN	REF.	MEDIDAS		CILINDRO		ACABADOS		UDS	
		B	A	FRENTE	CILINDRO				

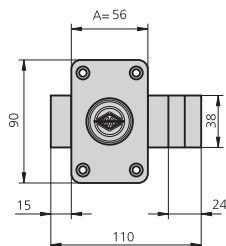

1988/0		56	Ø 26mm	HN	CL	1	24
1988/1		56	Ø 26mm	HE	CL	1	24

PICAPORTES **SERIE 234**

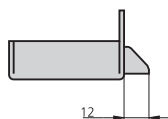

CARACTERÍSTICAS

- Picaporte reversible de sobreponer
- Picaporte accionable mediante manilla
- Cuadradillo para manilla de 8 mm
- Acabado en hierro esmaltado
- Cerradero CE234/1
- Embellecedor ES234

ACCESORIOS OPCIONALES



DESCRIPCIÓN	REF.	MEDIDAS		CILINDRO	ACABADOS		UDS	
		B	A		FRENTE	CILINDRO		

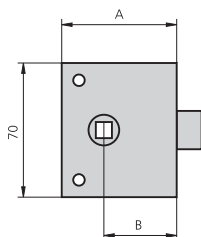

234/50/1	30	50	-	HE		6	120
234/60/1	38	60	-	HE		6	120
234/70/1	46	70	-	HE		6	120

CERRADURAS DE SOBREPONER

PICAPORTES

SERIE 236

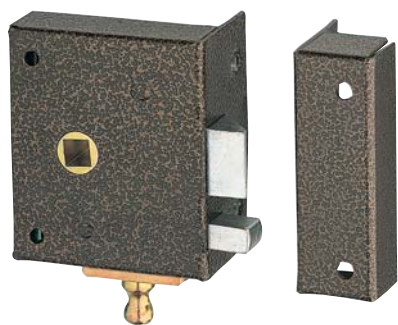

CARACTERÍSTICAS

- Picaporte reversible de sobreponer
- Condena accionable mediante tirador
- Cuadradillo para manilla de 8 mm
- Acabado en hierro esmaltado
- Cerradero CE236/1
- Embellecedor ES234

ACCESORIOS OPCIONALES

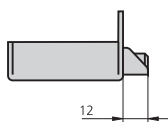

DESCRIPCIÓN

REF.

MEDIDAS

CILINDRO

ACABADOS

UDS

B

A

FRENTE

CILINDRO

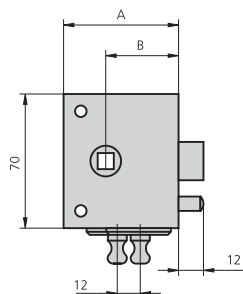

REF.	MEDIDAS B	MEDIDAS A	CILINDRO	ACABADOS FRENTE CILINDRO	UDS 	UDS
236/50/1	30	50	-	HE	6	120
236/60/1	38	60	-	HE	6	120
236/70/1	46	70	-	HE	6	120

CERRADURAS DE EMBUTIR PARA CARPINTERÍA DE MADERA

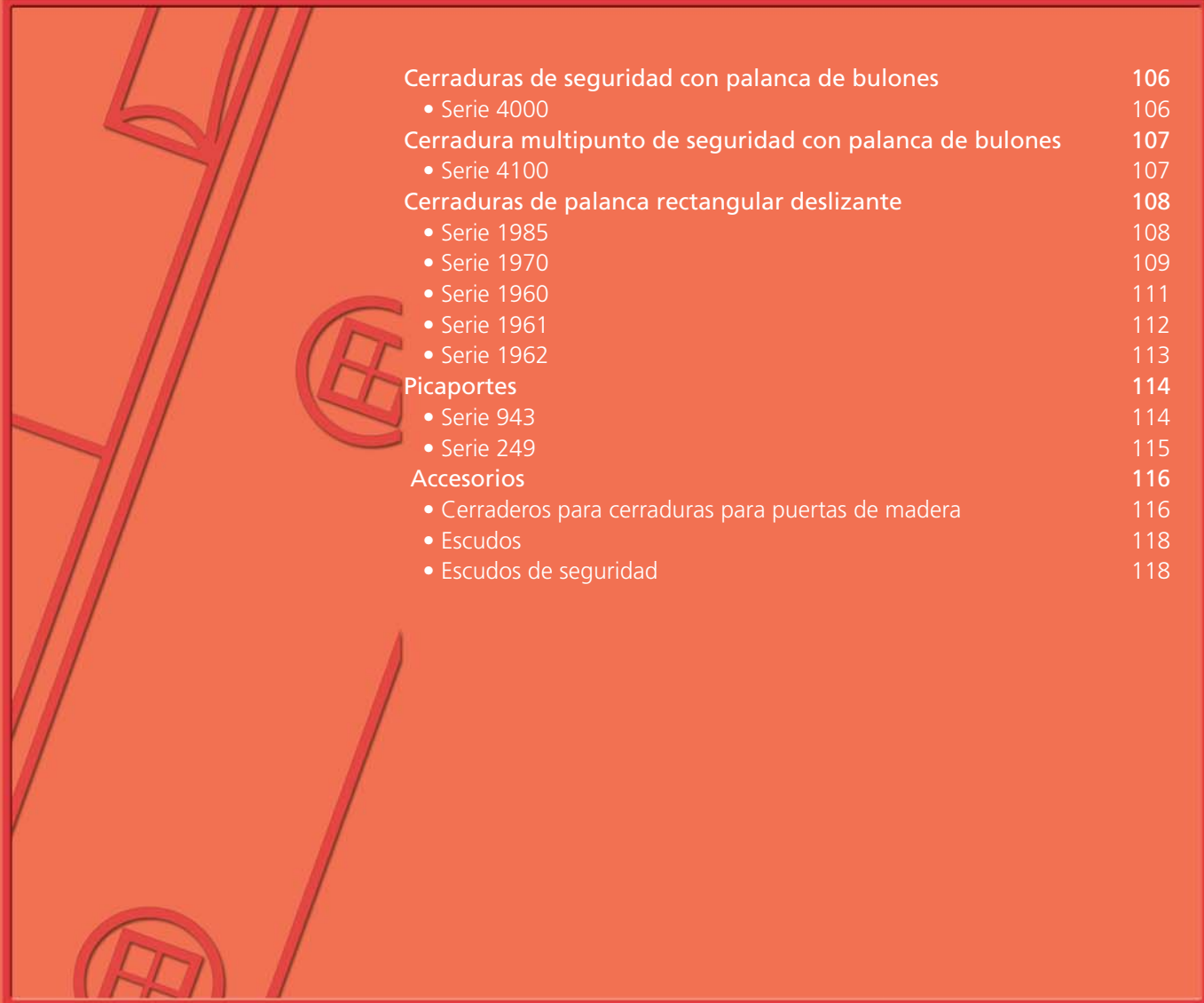

Cerraduras de seguridad con palanca de bulones	106
• Serie 4000	106
Cerradura multipunto de seguridad con palanca de bulones	107
• Serie 4100	107
Cerraduras de palanca rectangular deslizante	108
• Serie 1985	108
• Serie 1970	109
• Serie 1960	111
• Serie 1961	112
• Serie 1962	113
Picaportes	114
• Serie 943	114
• Serie 249	115
Accesorios	116
• Cerraderos para cerraduras para puertas de madera	116
• Escudos	118
• Escudos de seguridad	118

CERRADURAS DE SEGURIDAD CON PALANCA DE BULONES

SERIE 4000

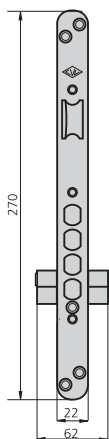

CARACTERÍSTICAS

- Cerradura de seguridad de 1 punto y palanca de 4 bulones de acero
- Entre ejes 85 mm
- Frente de hierro latonado o acero inoxidable disponible en canto redondo y canto cuadrado
- Picaporte reversible accionable mediante llave y manilla
- Cerradero de hierro latonado o acero inoxidable disponible en canto redondo y canto cuadrado
- Escudo protector de cilindro
- Cilindro de seguridad
- Otros acabados posibles: inox, pintado bronce ingles, pintado dorado, pintado plateado

ACCESORIOS OPCIONALES

- Gama completa de cilindros (ver páginas 119 - 140)

DESCRIPCIÓN	REF.	MEDIDAS		LEVA	ACABADOS		CANTO	UDS	
		B	A		FRENTE	CILINDRO			

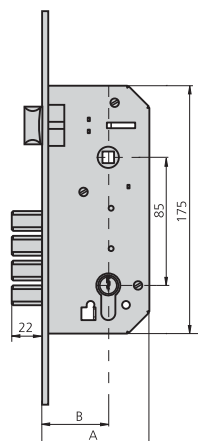

• Picaporte y palanca de 4 bulones de acero	4000/50/0	50	80	15	HN	CN	Red	1	12
	4001/50/0	50	80	15	HN	CN	Cua	1	12
• Cilindro de seguridad 6982/2525	4000/60/0	60	90	15	HN	CN	Red	1	12
	4001/60/0	60	90	15	HN	CN	Cua	1	12

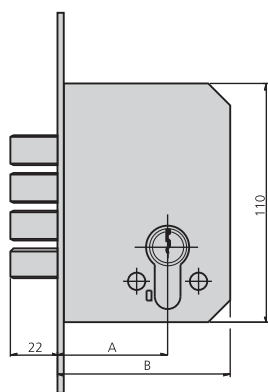

• Cerradura con sólo palanca de 4 bulones de acero	4000A50/0	50	80	15	HN	CN	Red	1	12
	4001A50/0	50	80	15	HN	CN	Cua	1	12
• Cilindro de seguridad 6982/2525	4000A60/0	60	90	15	HN	CN	Red	1	12
	4001A60/0	60	90	15	HN	CN	Cua	1	12

CERRADURA MULTIPUNTO DE SEGURIDAD CON PALANCA DE BULONES

SERIE 4100

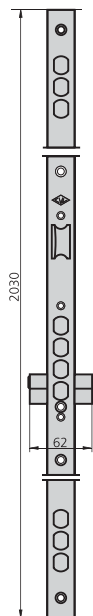
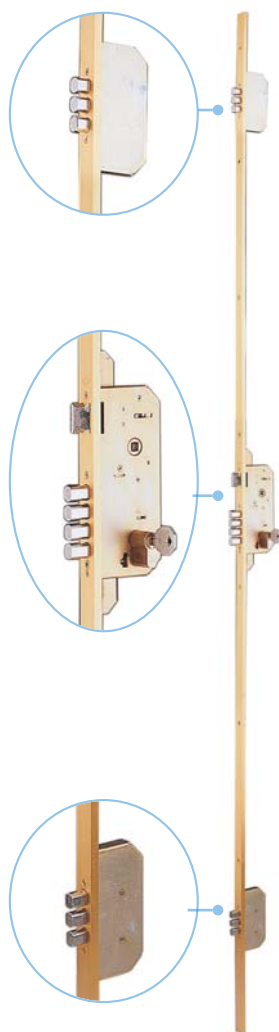

CARACTERÍSTICAS

- Cerradura de alta seguridad de 3 puntos de cierre mediante 10 bulones de acero
- Entre ejes 85 mm
- Frente largo de acero niquelado
- Picaporte reversible accionable mediante llave y manilla
- 3 cerraderos cortos de acero niquelado
- Escudo protector de cilindro de seguridad pintado dorado
- Cilindro de seguridad
- Otros acabados posibles: inox, pintado bronce ingles, pintado dorado, pintado plateado

ACCESORIOS OPCIONALES

- Gama completa de cilindros (ver páginas 119 - 140)

EMBUTIR PARA MADERA

DESCRIPCIÓN	REF.	MEDIDAS		LEVA	ACABADOS		UDS	
		B	A		FRENTE	CILINDRO		

- Cerradura de 3 puntos ref. 4100/50/0
- Cilindro de seguridad ref. 6982/2525/4

4100/50/0	50	80	15	HN			1
4100/60/0	60	90	15	HN			1

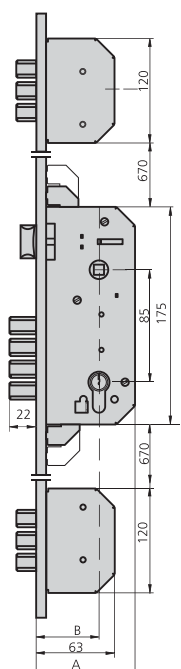

CERRADURAS DE PALANCA RECTANGULAR DESLIZANTE

SERIE 1985

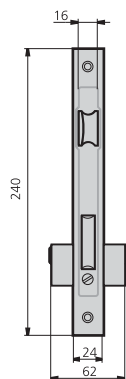

CARACTERÍSTICAS

- Entre ejes 85 mm
- Frente de hierro latonado o acero inoxidable
- Picaporte reversible accionable mediante llave y manilla
- Palanca deslizante a dos vueltas de llave
- Cerradero según cerradura
- Embellecedor ES1960
- Componentes de sujeción
- Cilindro europerfil

ACCESORIOS OPCIONALES

- Gama completa de cilindros (ver páginas 119 - 140)

DESCRIPCIÓN

REF.

MEDIDAS

LEVA

ACABADOS

UDS

B

A

FRENTE

CILINDRO

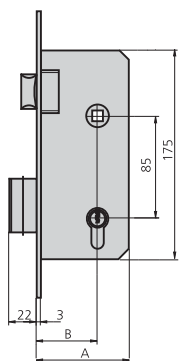

- Cerradura con resbalón y palanca
- Cilindro de leva larga 5982/2525
- Cerradero CE1985/2 o CE1985/6

1985/40/2	40	68	15	HL	CL	1	12
1985/40/6	40	68	15	AI	CN	1	12
1985/50/2	50	78	15	HL	CL	1	12
1985/50/6	50	78	15	AI	CN	1	12
1985/60/2	60	88	15	HL	CL	1	12
1985/60/6	60	88	15	AI	CN	1	12

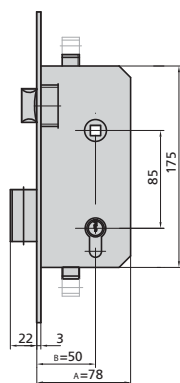

- Cerradura con picaporte y palanca
- 3 puntos de cierre
- Cilindro de leva larga 5982/2525
- Cerradero CE1985/2 o CE1985/6

1985/3P/2	50	78	15	HL	CL	1	12
-----------	----	----	----	----	----	---	----

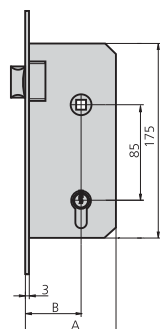

- Cerradura de sólo picaporte
- Con medio cilindro 5982T40
- Cerradero CE1970R/2 o CE1970R/6

1985T40/2	40	68	15	HL	CL	1	12
1985T40/6	40	68	15	AI	CN	1	12
1985T50/2	50	78	15	HL	CL	1	12
1985T50/6	50	78	15	AI	CN	1	12
1985T60/2	60	88	15	HL	CL	1	12
1985T60/6	60	88	15	AI	CN	1	12

CERRADURAS DE PALANCA RECTANGULAR DESLIZANTE

SERIE 1970

CARACTERÍSTICAS

- Entre ejes 70 mm
- Frente de hierro latonado o acero inoxidable
- Picaporte reversible accionable mediante llave y manilla
- Palanca deslizante a dos vueltas de llave
- Cerradero según cerradura
- Embellecedor ES1960
- Componentes de sujeción
- Cilindro europerfil

ACCESORIOS OPCIONALES

- Gama completa de cilindros (ver páginas 119 - 140)

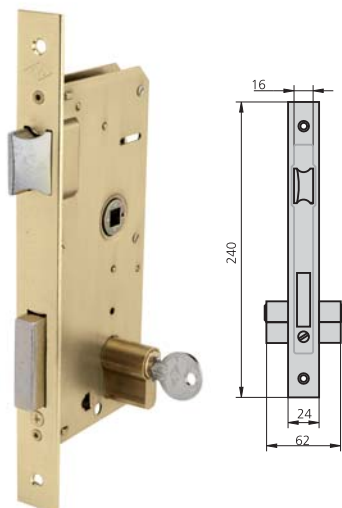

DESCRIPCIÓN	REF.	MEDIDAS		LEVA	ACABADOS		UDS	
		B	A		FRENTE	CILINDRO		

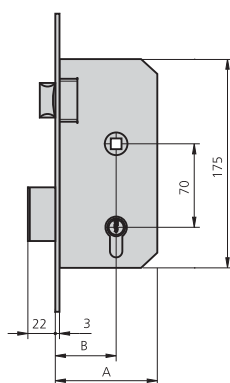

- Cerradura con picaporte y palanca
- Cilindro de leva larga 5982/2525
- Cerradero CE1985/2 o CE1985/6

1970/40/2	40	68	15	HL	CL	1	12
1970/40/6	40	68	15	AI	CN	1	12
1970/50/2	50	78	15	HL	CL	1	12
1970/50/6	50	78	15	AI	CN	1	12
1970/60/2	60	88	15	HL	CL	1	12
1970/60/6	60	88	15	AI	CN	1	12

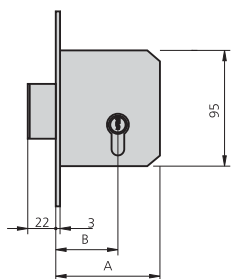

- Cerradura con sólo palanca
- Cilindro de leva larga 5982/2525
- Cerradero CE1970A/2 o CE1970A/6

1970A40/2	40	68	15	HL	CL	1	20
1970A40/6	40	68	15	AI	CN	1	20
1970A50/2	50	78	15	HL	CL	1	20
1970A50/6	50	78	15	AI	CN	1	20
1970A60/2	60	88	15	HL	CL	1	20
1970A60/6	60	88	15	AI	CN	1	20

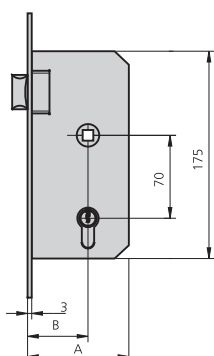

- Cerradura de sólo picaporte
- Con medio cilindro 5982T40
- Cerradero CE1970R/2 o CE1970R/6

1970T40/2	40	68	15	HL	CL	1	12
1970T40/6	40	68	15	AI	CN	1	12
1970T50/2	50	78	15	HL	CL	1	12
1970T50/6	50	78	15	AI	CN	1	12
1970T60/2	60	88	15	HL	CL	1	12
1970T60/6	60	88	15	AI	CN	1	12

CERRADURAS DE PALANCA RECTANGULAR DESLIZANTE

SERIE 1970

DESCRIPCIÓN	REF.	MEDIDAS		LEVA	ACABADOS		UDS	
		B	A		FRENTE	CILINDRO		
• Cerradura con rodillo y palanca	1970V40/2	40	68	15	HL	CL	1	12
	1970V40/6	40	68	15	Al	CN	1	12
• Con cilindro 5982/2525	1970V50/2	50	78	15	HL	CL	1	12
	1970V50/6	50	78	15	Al	CN	1	12
• Cerradero CE1985/2 o CE1985/6	1970V60/2	60	88	15	HL	CL	1	12
	1970V60/6	60	88	15	Al	CN	1	12

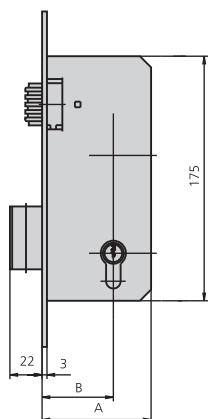

- Cerradura con rodillo y palanca
- Con cilindro 5982/2525
- Cerradero CE1985/2 o CE1985/6

CERRADURAS DE PALANCA RECTANGULAR DESLIZANTE

SERIE 1960

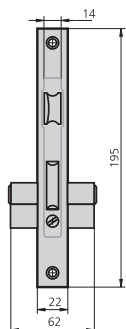

CARACTERÍSTICAS

- Entre ejes 48 mm
- Frente de hierro latonado o acero inoxidable
- Picaporte reversible accionable mediante llave y manilla
- Palanca deslizante accionado por una vuelta de llave
- Cerradero según cerradura
- Embellecedor ES1960
- Componentes de sujeción
- Cilindro europeo

ACCESORIOS OPCIONALES

- Gama completa de cilindros (ver páginas 119 - 140)

DESCRIPCIÓN	REF.	MEDIDAS		LEVA	ACABADOS		UDS	
		B	A		FRENTE	CILINDRO		

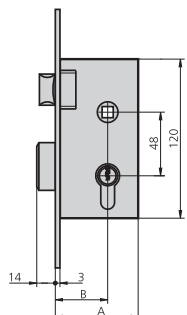

- Cerradura con picaporte y palanca
- Cilindro de leva larga 5982/2525
- Cerradero CE1960/2 o CE1960/6

1960/60/2	40	62	15	HL	CL	1	20
1960/60/6	40	62	15	AI	CN	1	20
1960/70/2	50	72	15	HL	CL	1	20
1960/70/6	50	72	15	AI	CN	1	20

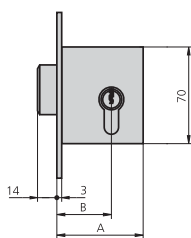

- Cerradura con sólo palanca
- Cilindro de leva larga 5982/2525
- Cerradero CE1960A/2 o CE1960A/6

1960A60/2	40	62	15	HL	CL	1	30
1960A60/6	40	62	15	AI	CN	1	30
1960A70/2	50	72	15	HL	CL	1	30
1960A70/6	50	72	15	AI	CN	1	30

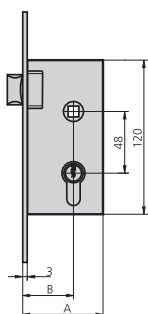

- Cerradura de sólo picaporte
- Con medio cilindro 5982T40
- Cerradero CE249R/2 o CE249R/6

1960T60/2	40	62	15	HL	CL	1	20
1960T60/6	40	62	15	AI	CN	1	20
1960T70/2	50	72	15	HL	CL	1	20
1960T70/6	50	72	15	AI	CN	1	20

CERRADURAS DE PALANCA RECTANGULAR DESLIZANTE

SERIE 1961

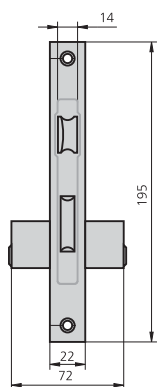

CARACTERÍSTICAS

- Frente de hierro latonado
- Picaporte reversible accionable mediante llave y manilla
- Palanca deslizante accionado por llave
- Cerradero según cerradura
- Embellecedor ES1964
- Componentes de sujeción
- Cilindro ovalado 5961/2525/3

ACCESORIOS OPCIONALES

- Gama completa de cilindros (ver páginas 119 - 140)

EMBUTIR PARA MADERA

DESCRIPCIÓN	REF.	MEDIDAS		LEVA	ACABADOS		UDS	
		B	A		FRENTE	CILINDRO		

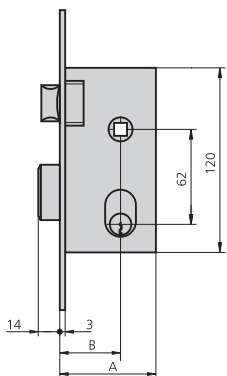

- Cerradura con picaporte y palanca
- Cerradero CE1960/2

1961/60/2	40	62	HL	CL	1	20
1961/70/2	50	72	HL	CL	1	20

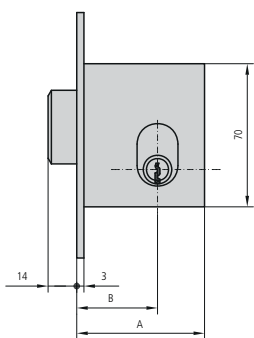

- Cerradura con sólo palanca
- Cerradero CE1960A/2

1961A60/2	40	62	HL	CL	1	20
1961A70/2	50	72	HL	CL	1	20

CERRADURAS DE PALANCA RECTANGULAR DESLIZANTE

SERIE 1962

CARACTERÍSTICAS

- Frente de hierro latonado
- Picaporte reversible accionable mediante llave y manilla
- Palanca deslizante accionado por llave
- Cerradero según cerradura
- Embellecedor ES1962
- Componentes de sujeción
- Cilindro redondo

ACCESORIOS OPCIONALES

- Gama completa de cilindros (ver páginas 119 - 140)

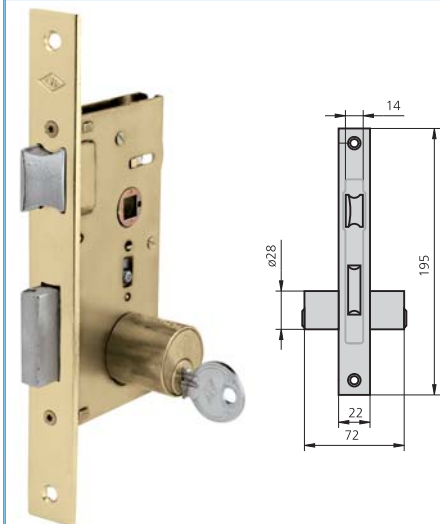

DESCRIPCIÓN	REF.	MEDIDAS		LEVA	ACABADOS		UDS	
		B	A		FRENTE	CILINDRO		

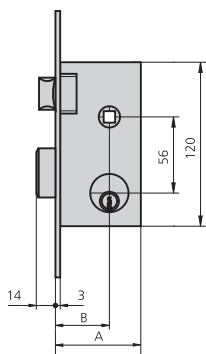

- Cerradura con picaporte y palanca
- Cilindro redondo 5962/2525/3
- Cerradero CE1960/2

1962/60/2	40	62	HL	CL	1	20
1962/70/2	50	72	HL	CL	1	20

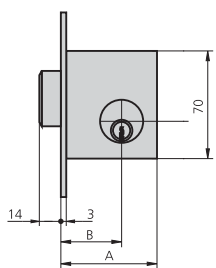

- Cerradura con sólo palanca
- Cilindro redondo 5962/2525/3
- Cerradero CE1960A/2

1962A60/2	40	62	HL	CL	1	30
1962A70/2	50	72	HL	CL	1	30

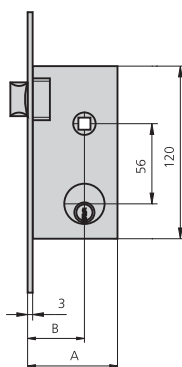

- Cerradura de sólo picaporte
- Medio cilindro redondo 5962T30/3
- Cerradero CE249R/2

1962T60/2	40	62	HL	CL	1	20
1962T70/2	50	72	HL	CL	1	20

PICAPORTES

SERIE 943

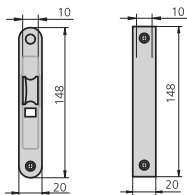

CARACTERÍSTICAS

- Picaporte unificado
- Frente de hierro latonado o níquel satinado
- Picaporte reversible accionable mediante manilla
- Condena a 47 mm y a 70 mm
- Cerradero CE942R30/2 o CE942R30/7
- Componentes de sujeción

ACCESORIOS OPCIONALES

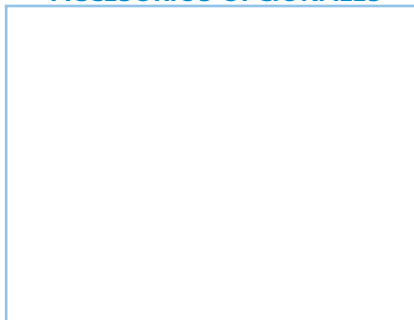

EMBUTIR PARA MADERA

DESCRIPCIÓN	REF.	MEDIDAS		LEVA	ACABADOS		UDS	
		B	A		FRENTE	CILINDRO		

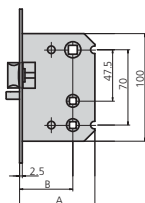

- Picaporte con condena
- Condena accionable mediante muletilla
- Canto redondo o canto cuadrado

943/2R	50	70	HL	Red	1	30
943/2C	50	70	HL	Cua	1	30
943/7R	50	70	NS	Red	1	30
943/7C	50	70	NS	Cua	1	30

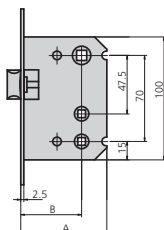

- Picaporte de paso
- Canto redondo o canto cuadrado

943P/2R	50	70	HL	Red	1	30
943P/2C	50	70	HL	Cua	1	30
943P/7R	50	70	NS	Red	1	30
943P/7C	50	70	NS	Cua	1	30

PICAPORTES **SERIE 249**

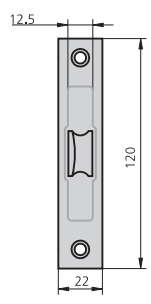

CARACTERÍSTICAS

- Frente de hierro latonado
- Picaporte reversible accionable mediante manilla
- Cerradero según cerradura
- Componentes de sujeción

ACCESORIOS OPCIONALES



DESCRIPCIÓN	REF.	MEDIDAS		LEVA	ACABADOS FRENTE CILINDRO	CANTO	UDS	
		B	A					

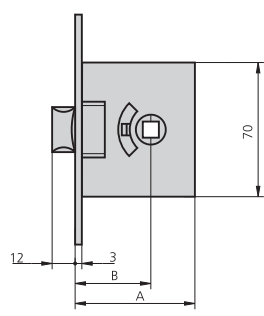

- Cerradura reversible
- Picaporte accionable mediante manilla
- Cerradero CE249R/2

249B50/2	37	52	HL			1	20
249B60/2	44	62	HL			1	20

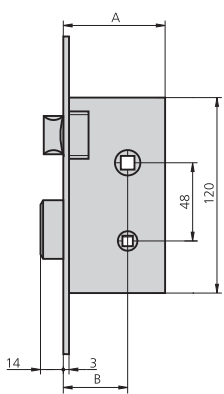

- Cerradura con picaporte y palanca
- Con condena
- Cerradero CE1960/2

249C50/2	30	52	HL			1	20
249C60/2	40	62	HL			1	20
249C70/2	50	72	HL			1	20

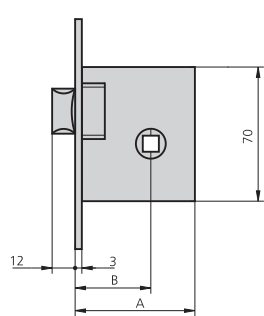

- Picaporte reversible accionable mediante manilla
- Cerradero CE249R/2

249R50/2	30	52	HL			1	30
249R60/2	40	62	HL			1	30
249R70/2	50	72	HL			1	30

EMBUTIR PARA MADERA

ACCESORIOS

CERRADEROS

DESCRIPCIÓN	REF.	ACABADO	APLICABLE A CERRADURAS	UDS
-------------	------	---------	------------------------	-----

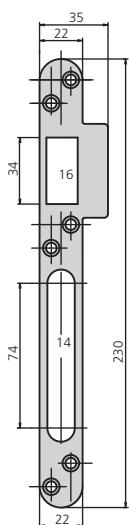

CE4000/2	HL	4000, 4010		
CE4000/6	AI			

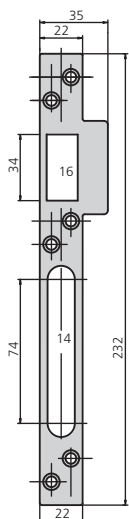

CE4001/2	HL	4001, 4011		
CE4001/6	AI			

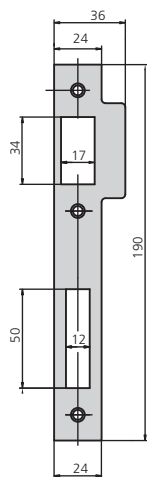

CE1985/2	HL	1970, 1970C, 1970V		
CE1985/6	AI	1985, 1985C, 1985/3P		



EMBUTIR PARA MADERA

ACCESORIOS **CERRADEROS**

DESCRIPCIÓN	REF.	ACABADO	APLICABLE A CERRADURAS	UDS
	CE1970R/2	HL	1970T, 1985T	
	CE1970R/6	Al		
	CE1970A/2	HL	1970A	
	CE1970A/6	Al		
	CE1960/2	HL	1960, 1961, 1962,	
	CE1960/6	Al	249C, 63R	
	CE1960A/2	HL	1960A, 1961A, 1962A,	
	CE1960A/6	Al		
	CE249R/2	HL	1960T, 1962T, 249B,	
	CE249R/6	Al	249R	
	CE942R25/2	HL	943/R, 943P/R, 942C/R,	
	CE942R30/2	HL	942R/R, 942RC/R	
	CE942R30/7	NS		
	CE942R35/2	HL		
	CE942R35/7	NS		



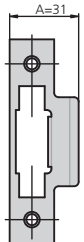



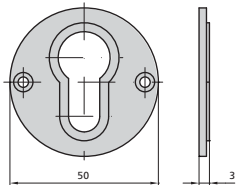

ACCESORIOS

CERRADEROS

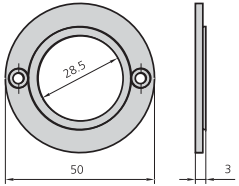
DESCRIPCIÓN	REF.	ACABADO	APLICABLE A CERRADURAS	UDS
	CE942C30/2	HL	942/C, 943P/C, 942C/C,	 
	CE942C35/2	HL	942R/C, 942RC/C	

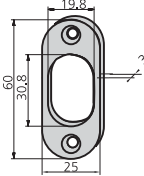

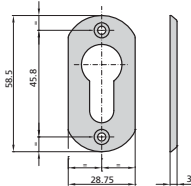

ACCESORIOS

ESCUDOS

DESCRIPCIÓN	REF.	ACABADO	APLICABLE A CERRADURAS	UDS
	ES1960	LP	1960, 1970,	 
	ES1960/4	LN	1985, 156	
	ES1962	LP	1962, 11981	 
	ES1962/4	LN		
	ES1964	Escudo de nylon	1961	 
	ES1985/0	Nickel plated	1985, 1970, 1960	 
	ES1985/1D	Gold painted		
	ES1985/2	Brass		
	ES1985/7	Matt nickel		

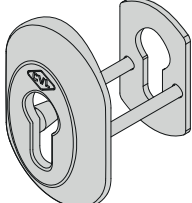
ACCESORIOS

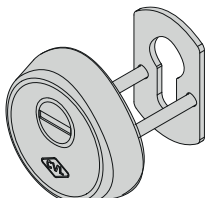
ESCUDOS DE SEGURIDAD

DESCRIPCIÓN	REF.	ACABADO	APLICABLE A CERRADURAS	UDS
	KES4000		4000, 4001, 4010, 4011, 4100, 4110	 
	KES4100		4000, 4001, 4010, 4011, 4100, 4110	 

CILINDROS

	Cilindro europerfil normal leva larga	120
	• Serie 5982	120
	• Serie 582PM, 5982T, 5982PT	122
	Cilindro europerfil normal leva corta	124
	• Serie 5990	124
	• Serie 590PM, 5990T, 5990PT	126
	Cilindro europerfil de seguridad leva larga	128
	• Serie 6982	128
	• Serie 682PM, 6982T	130
	Cilindro europerfil de seguridad leva corta	131
	• Serie 6990	131
	• Serie 690PM, 6990T	133
	Cilindros ovalados y redondos	134
	• Serie 5963	134
	• Serie 5081	135
• Serie 5961	136	
• Serie 5962	137	
• Serie 5964	138	
• Serie 5968	139	
• Serie 5979	140	

CILINDRO EUROPERFIL NORMAL LEVA LARGA

SERIE 5982

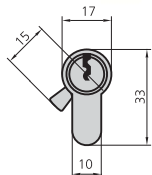

CARACTERÍSTICAS

- Cuerpo de latón
- Rotores de latón
- Leva larga de 15 mm
- 5 pitones
- 3 llaves

ACCESORIOS OPCIONALES

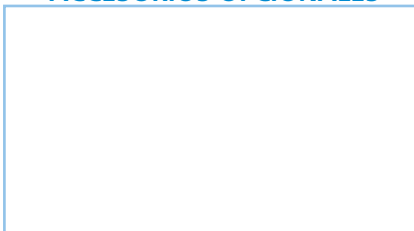

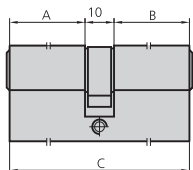

DESCRIPCIÓN	REF.	MEDIDAS			ACABADOS	UDS
		A	B	C		



• Cilindro doble



5982/2525/3	26	26	62	LP	1
5982/2525/4	26	26	62	LN	1
5982/2530/3	26	31	67	LP	1
5982/2530/4	26	31	67	LN	1
5982/2535/3	26	36	72	LP	1
5982/2535/4	26	36	72	LN	1
5982/3030/3	31	31	72	LP	1
5982/3030/4	31	31	72	LN	1
5982/2540/3	26	41	77	LP	1
5982/2540/4	26	41	77	LN	1
5982/3035/3	31	36	77	LP	1
5982/3035/4	31	36	77	LN	1
5982/2545/3	26	46	82	LP	1
5982/2545/4	26	46	82	LN	1
5982/3040/3	31	41	82	LP	1
5982/3040/4	31	41	82	LN	1
5982/3535/3	36	36	82	LP	1
5982/3535/4	36	36	82	LN	1
5982/2550/3	26	51	87	LP	1
5982/2550/4	26	51	87	LN	1
5982/3540/3	36	41	87	LP	1
5982/3540/4	36	41	87	LN	1
5982/3045/3	31	46	87	LP	1
5982/3045/4	31	46	87	LN	1
5982/2555/3	26	56	92	LP	1
5982/2555/4	26	56	92	LN	1
5982/3050/3	31	51	92	LP	1
5982/3050/4	31	51	92	LN	1
5982/3545/3	36	46	92	LP	1
5982/3545/4	36	46	92	LN	1
5982/4040/3	41	41	92	LP	1
5982/4040/4	41	41	92	LN	1
5982/2560/3	26	61	97	LP	1
5982/2560/4	26	61	97	LN	1
5982/3055/3	31	56	97	LP	1
5982/3055/4	31	56	97	LN	1
5982/2565/3	26	66	102	LP	1
5982/2565/4	26	66	102	LN	1
5982/3060/3	31	61	102	LP	1
5982/3060/4	31	61	102	LN	1
5982/3555/3	36	56	102	LP	1
5982/3555/4	36	56	102	LN	1

CILINDRO EUROPERFIL NORMAL LEVA LARGA
SERIE 5982



DESCRIPCIÓN	REF.	MEDIDAS			ACABADOS	UDS  
		A	B	C		
5982/4050/3	41	51	102	LP	1	
5982/4050/4	41	51	102	LN	1	
5982/4545/3	46	46	102	LP	1	
5982/4545/4	46	46	102	LN	1	
5982/4055/3	41	56	107	LP	1	
5982/4055/4	41	56	107	LN	1	
5982/2575/3	26	76	112	LP	1	
5982/2575/4	26	76	112	LN	1	
5982/3565/3	36	66	112	LP	1	
5982/3565/4	36	66	112	LN	1	
5982/4060/3	41	61	112	LP	1	
5982/4060/4	41	61	112	LN	1	
5982/4555/3	46	56	112	LP	1	
5982/4555/4	46	56	112	LN	1	
5982/5050/3	51	51	112	LP	1	
5982/5050/4	51	51	112	LN	1	
5982/2585/3	26	86	122	LP	1	
5982/2585/4	26	86	122	LN	1	
5982/3080/3	31	81	122	LP	1	
5982/3080/4	31	81	122	LN	1	
5982/3575/3	36	76	122	LP	1	
5982/3575/4	36	76	122	LN	1	
5982/4070/3	41	71	122	LP	1	
5982/4070/4	41	71	122	LN	1	
5982/5555/3	56	56	122	LP	1	
5982/5555/4	56	56	122	LN	1	
5982/2595/3	26	96	132	LP	1	
5982/2595/4	26	96	132	LN	1	
5982/4080/3	41	81	132	LP	1	
5982/4080/4	41	81	132	LN	1	
5982/6060/3	61	61	132	LP	1	
5982/6060/4	61	61	132	LN	1	
5982/3595/3	36	96	142	LP	1	
5982/3595/4	36	96	142	LN	1	
5982/6565/3	66	66	142	LP	1	
5982/6565/4	66	66	142	LN	1	
5982/7070/3	71	71	152	LP	1	
5982/7070/4	71	71	152	LN	1	
5982/7575/3	76	76	162	LP	1	
5982/7575/4	76	76	162	LN	1	

CILINDRO EUROPERFIL NORMAL LEVA LARGA

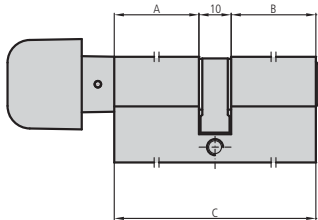
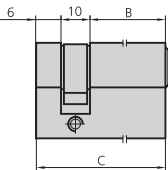
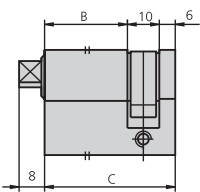
SERIE 582PM, 5982T, 5982PT

DESCRIPCIÓN	REF.	MEDIDAS			ACABADOS	UDS  
		A	B	C		
<ul style="list-style-type: none"> • Cilindro con pomo 	582PM2525/3	26	26	62	LP	1
	582PM2525/4	26	26	62	LN	1
	582PM2530/3	26	31	67	LP	1
	582PM2530/4	26	31	67	LN	1
	582PM2535/3	26	36	72	LP	1
	582PM2535/4	26	36	72	LN	1
	582PM3030/3	31	31	72	LP	1
	582PM3030/4	31	31	72	LN	1
	582PM3525/3	36	26	72	LP	1
	582PM3525/4	36	26	72	LN	1
	582PM2540/3	26	41	77	LP	1
	582PM2540/4	26	41	77	LN	1
	582PM2545/3	26	46	82	LP	1
	582PM2545/4	26	46	82	LN	1
	582PM3535/3	36	36	82	LP	1
	582PM3535/4	36	36	82	LN	1
	582PM2550/3	26	51	87	LP	1
	582PM2550/4	26	51	87	LN	1
	582PM3045/3	31	46	87	LP	1
	582PM3045/4	31	46	87	LN	1
	582PM3540/3	36	41	87	LP	1
	582PM3540/4	36	41	87	LN	1
	582PM2555/3	26	56	92	LP	1
	582PM2555/4	26	56	92	LN	1
	582PM3545/3	36	46	92	LP	1
	582PM3545/4	36	46	92	LN	1
	582PM2560/3	26	61	97	LP	1
	582PM2560/4	26	61	97	LN	1
	582PM2565/3	26	66	102	LP	1
	582PM2565/4	26	66	102	LN	1
<ul style="list-style-type: none"> • Medio cilindro 	5982T40/3		26	42	LP	1
	5982T40/4		26	42	LN	1
	5982T45/3		31	47	LP	1
	5982T45/4		31	47	LN	1
	5982T50/3		36	52	LP	1
	5982T50/4		36	52	LN	1
	5982T55/3		41	57	LP	1
	5982T55/4		41	57	LN	1
	5982T60/3		46	62	LP	1
	5982T60/4		46	62	LN	1
	5982T65/3		51	67	LP	1
	5982T65/4		51	67	LN	1
	5982T70/3		56	72	LP	1
	5982T70/4		56	72	LN	1
<ul style="list-style-type: none"> • Medio cilindro • Triángulo por un lado 	5982PT2505/3		26	42	LP	1
	5982PT2505/4		26	42	LN	1

CILINDRO EUROPERFIL NORMAL LEVA LARGA **SERIE 582PM, 5982T, 5982PT**

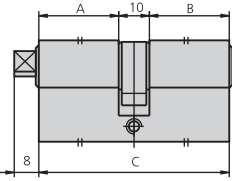
DESCRIPCIÓN	REF.	MEDIDAS			ACABADOS	UDS  
		A	B	C		
 <ul style="list-style-type: none"> • Doble cilindro • Llave por un lado y triángulo por el otro 	5982PT2525/3	26	26	62	LP	1
	5982PT2525/4	26	26	62	LN	1
	5982PT2535/3	26	36	72	LP	1
	5982PT2535/4	26	36	72	LN	1
	5982PT2545/3	26	46	82	LP	1
	5982PT2545/4	26	46	82	LN	1

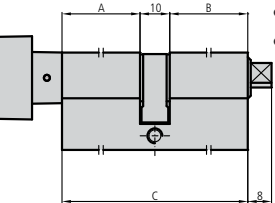
 <ul style="list-style-type: none"> • Doble cilindro • Triángulo por un lado y pomo por el otro 	582PM25T25/3	26	26	62	LP	1
	582PM25T25/4	26	26	62	LN	1
	582PM30T30/3	31	31	72	LP	1
	582PM30T30/4	31	31	72	LN	1
	582PM35T25/3	36	26	72	LP	1
	582PM35T25/4	36	26	72	LN	1
	582PM35T35/3	36	36	82	LP	1
	582PM35T35/4	36	36	82	LN	1
	582PM30T45/3	31	46	87	LP	1
	582PM30T45/4	31	46	87	LN	1

CILINDRO EUROPERFIL NORMAL LEVA CORTA

SERIE 5990



CARACTERÍSTICAS

- Cuerpo de latón
- Rotores de latón
- Leva corta de 13,25 mm
- 5 pitones
- 3 llaves

ACCESORIOS OPCIONALES

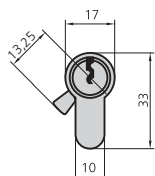

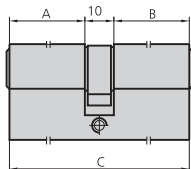

DESCRIPCIÓN	REF.	MEDIDAS			ACABADOS	UDS	
		A	B	C			





• Cilindro doble

5990/2525/3	26	26	62	LP	1
5990/2525/4	26	26	62	LN	1
5990/2530/3	26	31	67	LP	1
5990/2530/4	26	31	67	LN	1
5990/2535/3	26	36	72	LP	1
5990/2535/4	26	36	72	LN	1
5990/3030/3	31	31	72	LP	1
5990/3030/4	31	31	72	LN	1
5990/2540/3	26	41	77	LP	1
5990/2540/4	26	41	77	LN	1
5990/3035/3	31	36	77	LP	1
5990/3035/4	31	36	77	LN	1
5990/2545/3	26	46	82	LP	1
5990/2545/4	26	46	82	LN	1
5990/3040/3	31	41	82	LP	1
5990/3040/4	31	41	82	LN	1
5990/3535/3	36	36	82	LP	1
5990/3535/4	36	36	82	LN	1
5990/2550/3	26	51	87	LP	1
5990/2550/4	26	51	87	LN	1
5990/3540/3	36	41	87	LP	1
5990/3540/4	36	41	87	LN	1
5990/3045/3	31	46	87	LP	1
5990/3045/4	31	46	87	LN	1
5990/2555/3	26	56	92	LP	1
5990/2555/4	26	56	92	LN	1
5990/3050/3	31	51	92	LP	1
5990/3050/4	31	51	92	LN	1
5990/3545/3	36	46	92	LP	1
5990/3545/4	36	46	92	LN	1
5990/4040/3	41	41	92	LP	1
5990/4040/4	41	41	92	LN	1
5990/2560/3	26	61	97	LP	1
5990/2560/4	26	61	97	LN	1
5990/3055/3	31	56	97	LP	1
5990/3055/4	31	56	97	LN	1
5990/2565/3	26	66	102	LP	1
5990/2565/4	26	66	102	LN	1

CILINDRO EUROPERFIL NORMAL LEVA CORTA
SERIE 5990

DESCRIPCIÓN	REF.	MEDIDAS			ACABADOS	UDS	
		A	B	C			
	5990/3060/3	31	61	102	LP	1	
	5990/3060/4	31	61	102	LN	1	
	5990/3555/3	36	56	102	LP	1	
	5990/3555/4	36	56	102	LN	1	
	5990/4050/3	41	51	102	LP	1	
	5990/4050/4	41	51	102	LN	1	
	5990/4545/3	46	46	102	LP	1	
	5990/4545/4	46	46	102	LN	1	
	5990/4055/3	41	56	107	LP	1	
	5990/4055/4	41	56	107	LN	1	
	5990/2575/3	26	76	112	LP	1	
	5990/2575/4	26	76	112	LN	1	
	5990/3565/3	36	66	112	LP	1	
	5990/3565/4	36	66	112	LN	1	
	5990/4060/3	41	61	112	LP	1	
	5990/4060/4	41	61	112	LN	1	
	5990/4555/3	46	56	112	LP	1	
	5990/4555/4	46	56	112	LN	1	
	5990/5050/3	51	51	112	LP	1	
	5990/5050/4	51	51	112	LN	1	
	5990/2585/3	26	86	122	LP	1	
	5990/2585/4	26	86	122	LN	1	
	5990/3080/3	31	81	122	LP	1	
	5990/3080/4	31	81	122	LN	1	
	5990/3575/3	36	76	122	LP	1	
	5990/3575/4	36	76	122	LN	1	
	5990/4070/3	41	71	122	LP	1	
	5990/4070/4	41	71	122	LN	1	
	5990/5555/3	56	56	122	LP	1	
	5990/5555/4	56	56	122	LN	1	
	5990/2595/3	26	96	132	LP	1	
	5990/2595/4	26	96	132	LN	1	
	5990/4080/3	41	81	132	LP	1	
	5990/4080/4	41	81	132	LN	1	
	5990/6060/3	61	61	132	LP	1	
	5990/6060/4	61	61	132	LN	1	
	5990/3595/3	36	96	142	LP	1	
	5990/3595/4	36	96	142	LN	1	
	5990/6565/3	66	66	142	LP	1	
	5990/6565/4	66	66	142	LN	1	
	5990/7070/3	71	71	152	LP	1	
	5990/7070/4	71	71	152	LN	1	
	5990/7575/3	76	76	162	LP	1	
	5990/7575/4	76	76	162	LN	1	

CILINDRO EUROPERFIL NORMAL LEVA CORTA
SERIE 590PM, 5990T, 5990PT

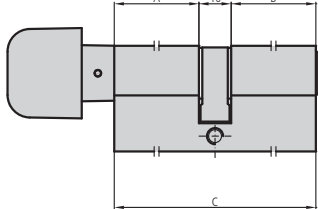
DESCRIPCIÓN	REF.	MEDIDAS			ACABADOS	UDS  
		A	B	C		
 <ul style="list-style-type: none"> Cilindro con pomo 	590PM2525/3	26	26	62	LP	1
	590PM2525/4	26	26	62	LN	1
	590PM2530/3	26	31	67	LP	1
	590PM2530/4	26	31	67	LN	1
	590PM2535/3	26	36	72	LP	1
	590PM2535/4	26	36	72	LN	1
	590PM3030/3	31	31	72	LP	1
	590PM3030/4	31	31	72	LN	1
	590PM3525/3	36	26	72	LP	1
	590PM3525/4	36	26	72	LN	1
	590PM2540/3	26	41	77	LP	1
	590PM2540/4	26	41	77	LN	1
	590PM2545/3	26	46	82	LP	1
	590PM2545/4	26	46	82	LN	1
	590PM3535/3	36	36	82	LP	1
	590PM3535/4	36	36	82	LN	1
	590PM2550/3	26	51	87	LP	1
	590PM2550/4	26	51	87	LN	1
	590PM3045/3	31	46	87	LP	1
	590PM3045/4	31	46	87	LN	1
	590PM3540/3	36	41	87	LP	1
	590PM3540/4	36	41	87	LN	1
	590PM2555/3	26	56	92	LP	1
	590PM2555/4	26	56	92	LN	1
	590PM3545/3	36	46	92	LP	1
	590PM3545/4	36	46	92	LN	1
	590PM2560/3	26	61	97	LP	1
	590PM2560/4	26	61	97	LN	1
	590PM2565/3	26	66	102	LP	1
	590PM2565/4	26	66	102	LN	1

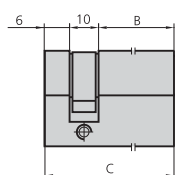

<ul style="list-style-type: none"> Medio cilindro 	5990T40/3	26	42	LP	1
	5990T40/4	26	42	LN	1
	5990T45/3	31	47	LP	1
	5990T45/4	31	47	LN	1
	5990T50/3	36	52	LP	1
	5990T50/4	36	52	LN	1
	5990T55/3	41	57	LP	1
	5990T55/4	41	57	LN	1
	5990T60/3	46	62	LP	1
	5990T60/4	46	62	LN	1
	5990T65/3	51	67	LP	1
	5990T65/4	51	67	LN	1
	5990T70/3	56	72	LP	1
	5990T70/4	56	72	LN	1

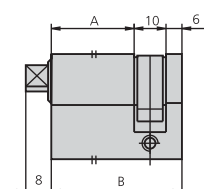

<ul style="list-style-type: none"> Medio cilindro Triángulo por un lado 	5990PT2505/3	26	42	LP	1
	5990PT2505/4	26	42	LN	1

CILINDRO EUROPERFIL NORMAL LEVA CORTA

SERIE 590PM, 5990T, 5990PT

DESCRIPCIÓN	REF.	MEDIDAS			ACABADOS	UDS	
		A	B	C			
<ul style="list-style-type: none"> • Doble cilindro • Llave por un lado y triángulo por el otro 	5990PT2525/3	26	26	62	LP	1	
	5990PT2525/4	26	26	62	LN	1	
	5990PT2535/3	26	36	72	LP	1	
	5990PT2535/4	26	36	72	LN	1	
	5990PT2545/3	26	46	82	LP	1	
	5990PT2545/4	26	46	82	LN	1	

<ul style="list-style-type: none"> • Doble cilindro • Triángulo por un lado y pomo por el otro 	590PM25T25/3	26	26	62	LP	1	
	590PM25T25/4	26	26	62	LN	1	
	590PM30T30/3	31	31	72	LP	1	
	590PM30T30/4	31	31	72	LN	1	
	590PM35T25/3	36	26	72	LP	1	
	590PM35T25/4	36	26	72	LN	1	
	590PM35T35/3	36	36	82	LP	1	
	590PM35T35/4	36	36	82	LN	1	
	590PM30T45/3	31	46	87	LP	1	
	590PM30T45/4	31	46	87	LN	1	

CILINDRO EUROPERFIL DE SEGURIDAD LEVA LARGA

SERIE 6982



CARACTERÍSTICAS

- Cuerpo de latón
- Rotores de latón
- Leva larga de 15 mm
- Pasadores antitaladro
- 5 pitones de inoxidable
- 5 llaves

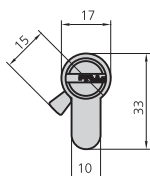

ACCESORIOS OPCIONALES

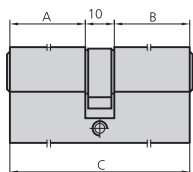

DESCRIPCIÓN	REF.	MEDIDAS			ACABADOS	UDS	
		A	B	C			
• Cilindro doble	6982/2525/3	26	26	62	LP	1	
	6982/2525/4	26	26	62	LN	1	
	6982/2530/3	26	31	67	LP	1	
	6982/2530/4	26	31	67	LN	1	
	6982/2535/3	26	36	72	LP	1	
	6982/2535/4	26	36	72	LN	1	
	6982/3030/3	31	31	72	LP	1	
	6982/3030/4	31	31	72	LN	1	
	6982/2540/3	26	41	77	LP	1	
	6982/2540/4	26	41	77	LN	1	
	6982/3035/3	31	36	77	LP	1	
	6982/3035/4	31	36	77	LN	1	
	6982/2545/3	26	46	82	LP	1	
	6982/2545/4	26	46	82	LN	1	
	6982/3040/3	31	41	82	LP	1	
	6982/3040/4	31	41	82	LN	1	
	6982/3535/3	36	36	82	LP	1	
	6982/3535/4	36	36	82	LN	1	
	6982/2550/3	26	51	87	LP	1	
	6982/2550/4	26	51	87	LN	1	
	6982/3540/3	36	41	87	LP	1	
	6982/3540/4	36	41	87	LN	1	
	6982/3045/3	31	46	87	LP	1	
	6982/3045/4	31	46	87	LN	1	
	6982/2555/3	26	56	92	LP	1	
	6982/2555/4	26	56	92	LN	1	
	6982/3050/3	31	51	92	LP	1	
	6982/3050/4	31	51	92	LN	1	
	6982/3545/3	36	46	92	LP	1	
	6982/3545/4	36	46	92	LN	1	
	6982/4040/3	41	41	92	LP	1	
	6982/4040/4	41	41	92	LN	1	
	6982/2560/3	26	61	97	LP	1	
	6982/2560/4	26	61	97	LN	1	
	6982/3055/3	31	56	97	LP	1	
	6982/3055/4	31	56	97	LN	1	
	6982/4045/3	41	46	97	LP	1	
	6982/4045/4	41	46	97	LN	1	





CILINDRO EUROPERFIL DE SEGURIDAD LEVA LARGA
SERIE 6982

DESCRIPCIÓN	REF.	MEDIDAS			ACABADOS	UDS  
		A	B	C		
	6982/2565/3	26	66	102	LP	1
	6982/2565/4	26	66	102	LN	1
	6982/3060/3	31	61	102	LP	1
	6982/3060/4	31	61	102	LN	1
	6982/3555/3	36	56	102	LP	1
	6982/3555/4	36	56	102	LN	1
	6982/4050/3	41	51	102	LP	1
	6982/4050/4	41	51	102	LN	1
	6982/4545/3	46	46	102	LP	1
	6982/4545/4	46	46	102	LN	1
	6982/4055/3	41	56	107	LP	1
	6982/4055/4	41	56	107	LN	1
	6982/2575/3	26	76	112	LP	1
	6982/2575/4	26	76	112	LN	1
	6982/3565/3	36	66	112	LP	1
	6982/3565/4	36	66	112	LN	1
	6982/4555/3	46	56	112	LP	1
	6982/4555/4	46	56	112	LN	1
	6982/5050/3	51	51	112	LP	1
	6982/5050/4	51	51	112	LN	1
	6982/4560/3	46	61	117	LP	1
	6982/4560/4	46	61	117	LN	1
	6982/2585/3	26	86	122	LP	1
	6982/2585/4	26	86	122	LN	1
	6982/5555/3	56	56	122	LP	1
	6982/5555/4	56	56	122	LN	1
	6982/2595/3	26	96	132	LP	1
	6982/2595/4	26	96	132	LN	1
	6982/6565/3	66	66	142	LP	1
	6982/6565/4	66	66	142	LN	1
	6982/7070/3	71	71	152	LP	1
	6982/7070/4	71	71	152	LN	1
	6982/7575/3	76	76	162	LP	1
	6982/7575/4	76	76	162	LN	1

CILINDRO EUROPERFIL DE SEGURIDAD LEVA LARGA

SERIE 682PM, 6982T

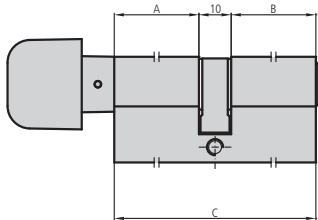
DESCRIPCIÓN	REF.	MEDIDAS			ACABADOS	UDS  
		A	B	C		
 <ul style="list-style-type: none"> • Cilindro con pomo 	682PM2525/3	26	26	62	LP	1
	682PM2525/4	26	26	62	LN	1
	682PM2535/3	26	36	72	LP	1
	682PM2535/4	26	36	72	LN	1
	682PM3525/3	36	26	72	LP	1
	682PM3525/4	36	26	72	LN	1
	682PM3030/3	31	31	72	LP	1
	682PM3030/4	31	31	72	LN	1
	682PM2545/3	26	46	82	LP	1
	682PM2545/4	26	46	82	LN	1
	682PM3535/3	36	36	82	LP	1
	682PM3535/4	36	36	82	LN	1
	682PM2555/3	26	56	92	LP	1
	682PM2555/4	26	56	92	LN	1
	682PM3545/3	36	46	92	LP	1
	682PM3545/4	36	46	92	LN	1
	682PM3555/3	36	56	102	LP	1
	682PM3555/4	36	56	102	LN	1
	682PM3565/3	36	66	112	LP	1
	682PM3565/4	36	66	112	LN	1

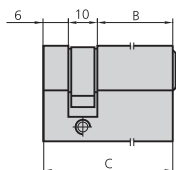
 <ul style="list-style-type: none"> • Medio cilindro 	6982T40/3	26	42	LP	1
	6982T40/4	26	42	LN	1
	6982T50/3	36	52	LP	1
	6982T50/4	36	52	LN	1
	6982T60/3	46	62	LP	1
	6982T60/4	46	62	LN	1
	6982T70/3	56	72	LP	1
	6982T70/4	56	72	LN	1

CILINDRO EUROPERFIL DE SEGURIDAD LEVA CORTA

SERIE 6990

CARACTERÍSTICAS

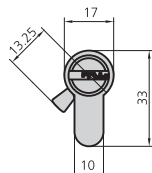

- Cuerpo de latón
- Rotores de latón
- Leva corta de 13,25 mm
- Pasadores antitaladro
- 5 pitones de inoxidable
- 5 llaves

ACCESORIOS OPCIONALES





DESCRIPCIÓN	REF.	MEDIDAS			ACABADOS	UDS	
		A	B	C			
• Cilindro doble	6990/2525/3	26	26	62	LP	1	
	6990/2525/4	26	26	62	LN	1	
	6990/2530/3	26	31	67	LP	1	
	6990/2530/4	26	31	67	LN	1	
	6990/2535/3	26	36	72	LP	1	
	6990/2535/4	26	36	72	LN	1	
	6990/3030/3	31	31	72	LP	1	
	6990/3030/4	31	31	72	LN	1	
	6990/2540/3	26	41	77	LP	1	
	6990/2540/4	26	41	77	LN	1	
	6990/3035/3	31	36	77	LP	1	
	6990/3035/4	31	36	77	LN	1	
	6990/2545/3	26	46	82	LP	1	
	6990/2545/4	26	46	82	LN	1	
	6990/3040/3	31	41	82	LP	1	
	6990/3040/4	31	41	82	LN	1	
	6990/3535/3	36	36	82	LP	1	
	6990/3535/4	36	36	82	LN	1	
	6990/2550/3	26	51	87	LP	1	
	6990/2550/4	26	51	87	LN	1	
	6990/3540/3	36	41	87	LP	1	
	6990/3540/4	36	41	87	LN	1	
	6990/3045/3	31	46	87	LP	1	
	6990/3045/4	31	46	87	LN	1	
	6990/2555/3	26	56	92	LP	1	
	6990/2555/4	26	56	92	LN	1	
	6990/3050/3	31	51	92	LP	1	
	6990/3050/4	31	51	92	LN	1	
	6990/3545/3	36	46	92	LP	1	
	6990/3545/4	36	46	92	LN	1	
	6990/4040/3	41	41	92	LP	1	
	6990/4040/4	41	41	92	LN	1	
	6990/2560/3	26	61	97	LP	1	
	6990/2560/4	26	61	97	LN	1	
	6990/3055/3	31	56	97	LP	1	
	6990/3055/4	31	56	97	LN	1	
	6990/4045/3	41	46	97	LP	1	
	6990/4045/4	41	46	97	LN	1	

CILINDRO EUROPERFIL DE SEGURIDAD LEVA CORTA
SERIE 6990

DESCRIPCIÓN	REF.	MEDIDAS			ACABADOS	UDS	
		A	B	C			
	6990/2565/3	26	66	102	LP	1	
	6990/2565/4	26	66	102	LN	1	
	6990/3060/3	31	61	102	LP	1	
	6990/3060/4	31	61	102	LN	1	
	6990/3555/3	36	56	102	LP	1	
	6990/3555/4	36	56	102	LN	1	
	6990/4050/3	41	51	102	LP	1	
	6990/4050/4	41	51	102	LN	1	
	6990/4545/3	46	46	102	LP	1	
	6990/4545/4	46	46	102	LN	1	
	6990/4055/3	41	56	107	LP	1	
	6990/4055/4	41	56	107	LN	1	
	6990/2575/3	26	76	112	LP	1	
	6990/2575/4	26	76	112	LN	1	
	6990/3565/3	36	66	112	LP	1	
	6990/3565/4	36	66	112	LN	1	
	6990/4555/3	46	56	112	LP	1	
	6990/4555/4	46	56	112	LN	1	
	6990/5050/3	51	51	112	LP	1	
	6990/5050/4	51	51	112	LN	1	
	6990/4560/3	46	61	117	LP	1	
	6990/4560/4	46	61	117	LN	1	
	6990/2585/3	26	86	122	LP	1	
	6990/2585/4	26	86	122	LN	1	
	6990/5555/3	56	56	122	LP	1	
	6990/5555/4	56	56	122	LN	1	
	6990/2595/3	26	96	132	LP	1	
	6990/2595/4	26	96	132	LN	1	
	6990/6565/3	66	66	142	LP	1	
	6990/6565/4	66	66	142	LN	1	
	6990/7070/3	71	71	152	LP	1	
	6990/7070/4	71	71	152	LN	1	
	6990/7575/3	76	76	162	LP	1	
	6990/7575/4	76	76	162	LN	1	

CILINDRO EUROPERFIL DE SEGURIDAD LEVA CORTA

SERIE 690PM, 6990T

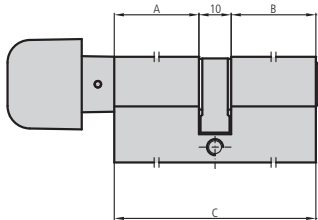
DESCRIPCIÓN	REF.	MEDIDAS			ACABADOS	UDS  
		A	B	C		
<ul style="list-style-type: none"> • Cilindro con pomo 	690PM2525/3	26	26	62	LP	1
	690PM2525/4	26	26	62	LN	1
	690PM2535/3	26	36	72	LP	1
	690PM2535/4	26	36	72	LN	1
	690PM3525/3	36	26	72	LP	1
	690PM3525/4	36	26	72	LN	1
	690PM3030/3	31	31	72	LP	1
	690PM3030/4	31	31	72	LN	1
	690PM2545/3	26	46	82	LP	1
	690PM2545/4	26	46	82	LN	1
	690PM3535/3	36	36	82	LP	1
	690PM3535/4	36	36	82	LN	1
	690PM2555/3	26	56	92	LP	1
	690PM2555/4	26	56	92	LN	1
	690PM3545/3	36	46	92	LP	1
	690PM3545/4	36	46	92	LN	1
	690PM3555/3	36	56	102	LP	1
	690PM3555/4	36	56	102	LN	1
	690PM3565/3	36	66	112	LP	1
	690PM3565/4	36	66	112	LN	1

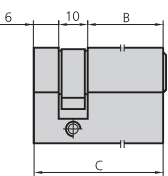
<ul style="list-style-type: none"> • Medio cilindro 	6990T40/3		26	42	LP	1
	6990T40/4		26	42	LN	1
	6990T50/3		36	52	LP	1
	6990T50/4		36	52	LN	1
	6990T60/3		46	62	LP	1
	6990T60/4		46	62	LN	1
	6990T70/3		56	72	LP	1
	6990T70/4		56	72	LN	1

CILINDROS OVALADOS Y REDONDOS **SERIE 5963**



CARACTERÍSTICAS

- Cilindro ovalado pequeño
- Cuerpo de latón
- Rotores de latón
- Dos levas

- 3 llaves

ACCESORIOS OPCIONALES

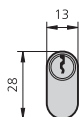

DESCRIPCIÓN	REF.	MEDIDAS			ACABADOS	APLICABLE A CERRADURAS	UDS	
		A	B	C				
<ul style="list-style-type: none"> • Cilindro doble 	5963/2222/3	22	22	54	LP	1963 1975	1	
	5963/2222/4	22	22	54	LN		1	
	5963/2525/3	26	26	62	LP		1	
	5963/2525/4	26	26	62	LN		1	
	5963/3030/3	31	31	72	LP		1	
	5963/3030/4	31	31	72	LN		1	
	5963/3535/3	36	36	82	LP		1	
	5963/3535/4	36	36	82	LN		1	
	5963/4040/3	41	41	92	LP		1	
	5963/4040/4	41	41	92	LN		1	
<ul style="list-style-type: none"> • Medio cilindro 	5963T36/3		22	36	LP	1963	1	
	5963T36/4		22	36	LN	1975	1	

CILINDROS

CILINDROS OVALADOS Y REDONDOS

SERIE 5081



CARACTERÍSTICAS

- Cuerpo de latón
- Rotores de latón
- Con levas y vástagos
- 3 llaves

ACCESORIOS OPCIONALES

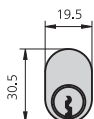

DESCRIPCIÓN	REF.	MEDIDAS			ACABADOS	APLICABLE A CERRADURAS	UDS	
		A	B	C				
<ul style="list-style-type: none"> • Cilindro doble • Ovalado 	5081/3030/3	26,5	26,5	74	LP	1981	1	
	5081/3030/4	26,5	26,5	74	LN		1	
<ul style="list-style-type: none"> • Cilindro doble • Redondo 	5181/3030/3	26,5	26,5	74	LP	11981	1	
	5181/3030/4	26,5	26,5	74	LN		1	

CILINDROS OVALADOS Y REDONDOS

SERIE 5961



CARACTERÍSTICAS

- Cuerpo de latón
- Rotores de latón
- Con levas y vástagos
- 3 llaves

ACCESORIOS OPCIONALES

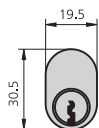

DESCRIPCIÓN	REF.	MEDIDAS			ACABADOS	APLICABLE A CERRADURAS	UDS	
		A	B	C				
<ul style="list-style-type: none"> • Cilindro doble • Ovalado 	5961/2525/3	25	25	64	LP	1961		1
	5961/2525/4	25	25	64	LN			1
	5961/3030/3	30	30	74	LP			1
	5961/3030/4	30	30	74	LN			1

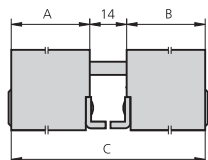

CILINDROS OVALADOS Y REDONDOS **SERIE 5962**



CARACTERÍSTICAS

- Cuerpo de latón
- Rotores de latón
- Con levas y vástagos
- 3 llaves

ACCESORIOS OPCIONALES



DESCRIPCIÓN	REF.	MEDIDAS			ACABADOS	APLICABLE A CERRADURAS	UDS	
		A	B	C				
<ul style="list-style-type: none"> • Cilindro doble • Redondo 	5962/2525/3	25	25	64	LP	1962		1
	5962/3030/3	30	30	74	LN			1
	5962/4040/3	40	40	94	LP			1
<ul style="list-style-type: none"> • Medio cilindro • Redondo 	5962T30/3			30	LP	1962		1
	5962T40/3			40	LN			1

CILINDROS OVALADOS Y REDONDOS

SERIE 5964

CARACTERÍSTICAS

- Cilindro ovalado
- Cuerpo de latón
- Rotores de latón
- Con levas y vástagos
- 3 llaves

ACCESORIOS OPCIONALES

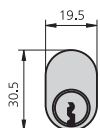

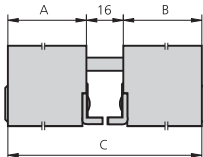
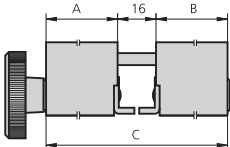
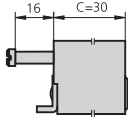
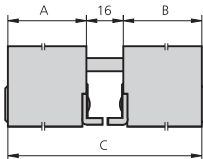
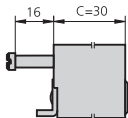
DESCRIPCIÓN	REF.	MEDIDAS			ACABADOS	APLICABLE A CERRADURAS	UDS	
		A	B	C				
 <ul style="list-style-type: none"> • Cilindro doble • Llave normal 	5964/2525/3	25	25	66	LP	1964	1	
	5964/2525/4	25	25	66	LN		1	
	5964/3030/3	30	30	76	LP		1	
	5964/3030/4	30	30	76	LN		1	
	5964/4040/3	40	40	96	LP		1	
	5964/4040/4	40	40	96	LN		1	
 <ul style="list-style-type: none"> • Cilindro doble con pomo • Llave normal 	5964P3030/3	30	30	76	LP	1964	1	
	5964P3030/4	30	30	76	LN		1	
 <ul style="list-style-type: none"> • Medio cilindro • Llave normal 	5964T25/3			25	LP	1964	1	
	5964T25/4			25	LN		1	
	5964T30/3			30	LP		1	
	5964T30/4			30	LN		1	
	5964T40/3			40	LP		1	
5964T40/4			40	LN	1			
 <ul style="list-style-type: none"> • Cilindro doble • Llave de seguridad 	6964/3030/3	30	30	76	LP	1964	1	
	6964/3030/4	30	30	76	LN		1	
 <ul style="list-style-type: none"> • Medio cilindro • Llave de seguridad 	6964T30/3			30	LP	1964	1	
	6964T30/4			30	LN		1	

CILINDROS OVALADOS Y REDONDOS **SERIE 5968**



CARACTERÍSTICAS

- Cilindro ovalado
- Cuerpo de latón
- Rotores de latón
- Con levas y vástagos
- 3 llaves

ACCESORIOS OPCIONALES

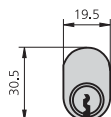

DESCRIPCIÓN	REF.	MEDIDAS			ACABADOS	APLICABLE A CERRADURAS	UDS	
		A	B	C				
<ul style="list-style-type: none"> • Cilindro doble • Llave normal 	5968/2525/3	25	25	66	LP	1968	1	
	5968/2525/4	25	25	66	LN		1	
	5968/3030/3	30	30	76	LP		1	
	5968/3030/4	30	30	76	LN		1	
	5968/4040/3	40	40	96	LP		1	
	5968/4040/4	40	40	96	LN		1	
<ul style="list-style-type: none"> • Cilindro doble con pomo • Llave normal 	5968P3030/3	30	30	76	LP	1968	1	
	5968P3030/4	30	30	76	LN		1	
<ul style="list-style-type: none"> • Medio cilindro • Llave normal 	5968T25/3			25	LP	1968	1	
	5968T25/4			25	LN		1	
	5968T30/3			30	LP		1	
	5968T30/4			30	LN		1	
	5968T40/3			40	LP		1	
	5968T40/4			40	LN		1	
<ul style="list-style-type: none"> • Cilindro doble • Llave de seguridad 	6968/3030/3	30	30	76	LP	1968	1	
	6968/3030/4	30	30	76	LN		1	
<ul style="list-style-type: none"> • Medio cilindro • Llave de seguridad 	6968T30/3			30	LP	1968	1	
	6968T30/4			30	LN		1	

CILINDROS OVALADOS Y REDONDOS **SERIE 5979**



CARACTERÍSTICAS

- Cilindro ovalado
- Cuerpo de latón
- Rotores de latón
- Con levas y vástagos

- 3 llaves

ACCESORIOS OPCIONALES

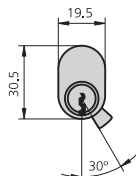

DESCRIPCIÓN	REF.	MEDIDAS			ACABADOS	APLICABLE A CERRADURAS	UDS	
		A	B	C				
<ul style="list-style-type: none"> • Cilindro doble 	5979/3030/3	30	30	76	LP	1979	1	
	5979/3030/4	30	30	76	LN		1	
<ul style="list-style-type: none"> • Cilindro doble con pomo 	5979P3030/3	30	30	76	LP	1979P	1	
	5979P3030/4	30	30	76	LN		1	

VÍAS DE ESCAPE Y CORTAFUEGO

	Barra Antipánico de Cierre Lateral con Marcado CE	143
	• Serie 5000	143
	Barra Antipánico acoplable a cerradura de embutir con Marcado CE	144
	• Serie 5500	144
	Barra Antipánico de cierre alto-bajo con Marcado CE	145
	• Serie 6000	145
	 Cerradura antipánico palanca deslizante entre ejes 85 mm	146
	• Serie 615 alupanic	146
	• Serie 615E alupanic	147
	 Cerradura antipánico palanca deslizante entre ejes 92 mm	148
	• Serie 612 alupanic	148
	• Serie 612E alupanic	149
	Cerradura con certificado EN12209	150
	• Serie 400	150
	• Serie 400T	151
Cerradura Cortafuego y Antipánico con Marcado CE	152	
• Serie 410	152	
Cerradura Antipánico	155	
• Serie 3000	155	
Cerraduras Electromagnéticas	157	
Accesorios	158	
• Escudos y Manillas de Acero Inoxidable	158	
• Escudos y Manillas en negro	159	
• Cilindros y otros accesorios	160	

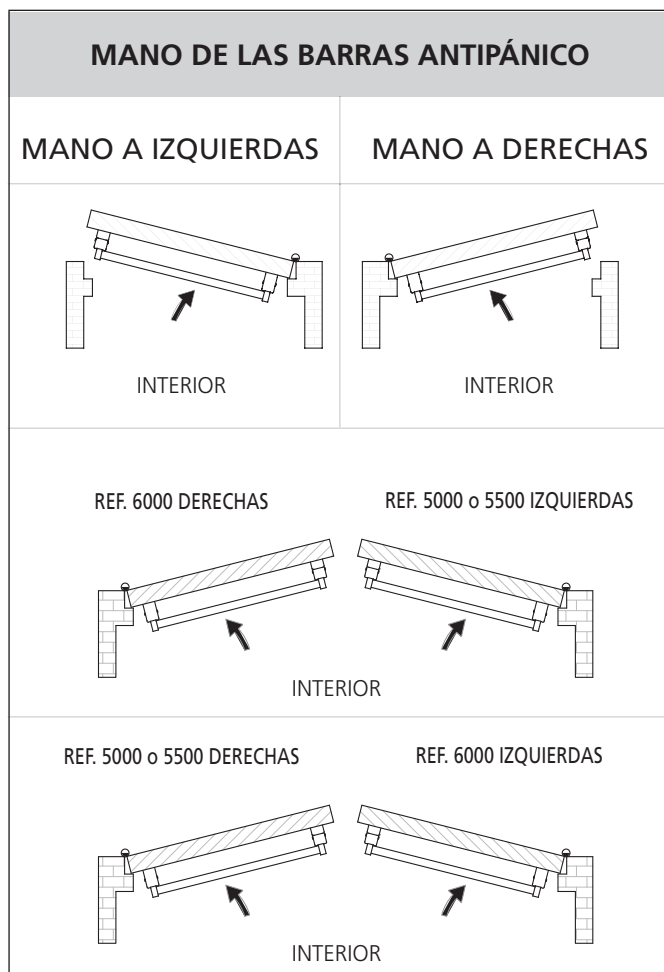
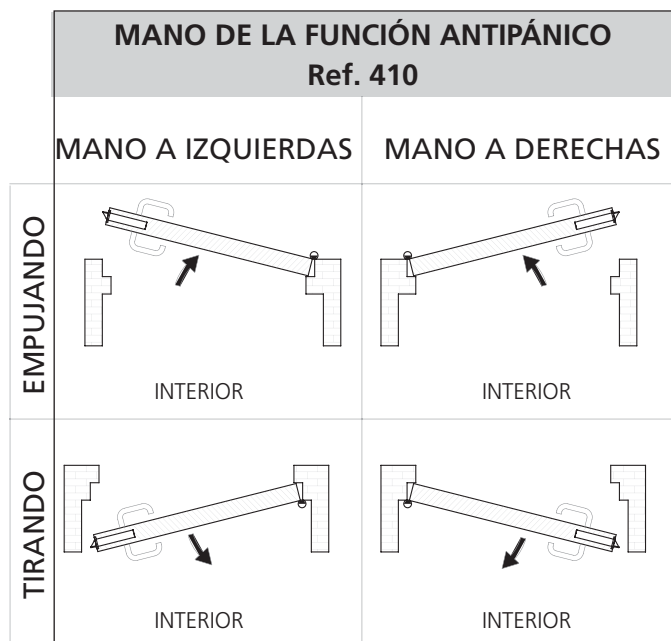

BARRA ANTIPÁNICO DE CIERRE LATERAL CON MARCADO CE

SERIE 5000

CARACTERÍSTICAS

- 1 punto de cierre lateral
- Solución reversible
- Cerradero CE5000
- Certificado según norma europea UNE-EN 1125

ACCESORIOS OPCIONALES

- Barra de apoyo de medidas especiales
- Manilla y escudo en negro M5000, M5001, M5002, M5003
- Manilla y escudo de acero inoxidable CM5006, CM5007, CM5008, CM5009 para distintos entre ejes
- Cilindro B5000



ANTIPÁNICO INOX



ANTIPÁNICO NIQUEL MATE



ANTIPÁNICO NEGRO



DESCRIPCIÓN	REF.	ACABADOS		UDS	
		SOPORTE	BARRA		
	5000/1N	Pintado negro	Pintado rojo	1	
	5000/1NM	Níquel mate	Acero inoxidable Aisi 304L	1	
	5000/6	Acero inoxidable Aisi 304L	Acero inoxidable Aisi 304L	1	

BARRA ANTIPÁNICO ACOPLABLE A CERRADURA DE EMBUTIR CON MARCADO CE

SERIE 5500



CARACTERÍSTICAS

- Acoplable a cerradura de embutir
- Solución reversible
- Certificado según norma europea UNE-EN 1125

ACCESORIOS OPCIONALES

- Cerradura antipánico serie 400LT y 400T
- Barra de apoyo de medidas especiales
- Manilla y escudo de acero inoxidable CM5008, CM5009
- Pomo y escudo en acero inoxidable CM5005 para distintos entre ejes



DESCRIPCIÓN	REF.	ACABADOS		UDS	
		SOPORTE	BARRA		
	5500/1N	Pintado negro	Pintado rojo	1	5
	5500/1NM	Níquel mate	Acero inoxidable Aisi 304L	1	5
	5500/6	Acero inoxidable	Acero inoxidable	1	5
		Aisi 304L	Aisi 304L		

VÍAS DE ESCAPE Y CORTAFUEGO

FIRERATED LOCKS



400T + tirador
(ver página 151)



400LT + tirador
(ver página 151)

BARRA ANTIPÁNICO DE CIERRE ALTO-BAJO CON MARCADO CE

SERIE 6000

CARACTERÍSTICAS

- 2 puntos de cierre alto-bajo
- Reversible sin accionamiento exterior
- Cerraderos CER5000 y CEB6000
- Certificado según norma europea UNE-EN 1125

ACCESORIOS OPCIONALES

- Barra de apoyo y fallebas de medidas especiales
- Manilla y escudo en negro M5000, M5001, M5002, M5003
- Manilla y escudo de acero inoxidable CM5006, CM5007, CM5008, CM5009 para distintos entre ejes
- Cilindro B5000

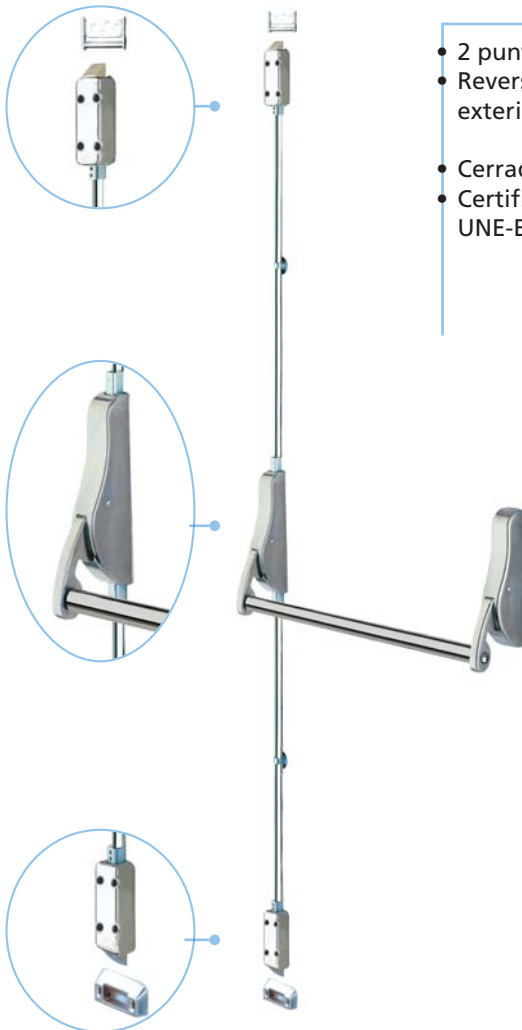

DESCRIPCIÓN	REF.	ACABADOS			UDS	
		SOPORTE	BARRA	FALLEBA		
	6000D/1N	Pintado negro	Pintado rojo	Pintado negro	1	5
	6000I/1N	Pintado negro	Pintado rojo	Pintado negro	1	5
	6000D/1NM	Níquel mate	Acero inoxidable Aisi 304L	Acero inoxidable Aisi 304L	1	5
	6000I/1NM	Níquel mate	Acero inoxidable Aisi 304L	Acero inoxidable Aisi 304L	1	5
	6000D/6	Acero inoxidable Aisi 304L	Acero inoxidable Aisi 304L	Acero inoxidable Aisi 304L	1	5
	6000I/6	Acero inoxidable Aisi 304L	Acero inoxidable Aisi 304L	Acero inoxidable Aisi 304L	1	5

CERRADURA ANTIPÁNICO PALANCA DESLIZANTE ENTRE EJES 85 mm

SERIE 615 alupanic



CARACTERÍSTICAS

- Cerradura antipánico para puertas de aluminio y metálicas
- Sistema antipánico reversible
- Frente inox. de 22 mm
- Picaporte reversible de 11 mm
- Picaporte regulable, excepto en entrada de 25 mm
- Caja de 15 mm
- Cuadradillo de 8 mm
- Operado mediante llave y pomo o manilla desde el exterior
- Tornillo de fijación de cilindro

ACCESORIOS OPCIONALES

- Gama completa de cerraderos (ver páginas 39 - 45)
- Gama completa de cilindros (ver páginas 119 - 140)

DESCRIPCIÓN	REF.	MEDIDAS		LEVA	ACABADOS		UDS
		B	A		FRENTE	CANTO	

NUECA PARTIDA

- Opciones de cerradero (ver páginas 39 - 45)
- Opciones de cerradero eléctrico (ver página 49)

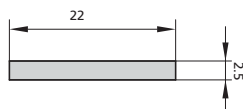
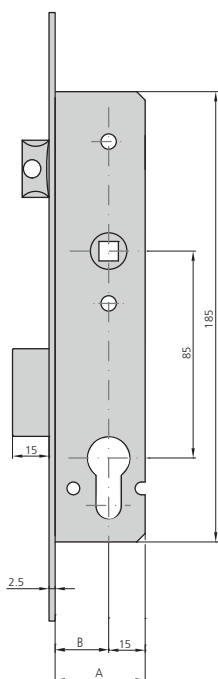

615/25/6	22	37	15	Al	1	20
615/30/6	27	42	15	Al	1	20
615/35/6	32	47	15	Al	1	20

NUECA PASANTE

- Picaporte y palanca
- Cilindro no incluido

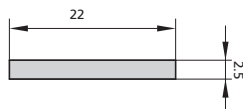

615P25/6	22	37	15	Al	1	20
615P30/6	27	42	15	Al	1	20
615P35/6	32	47	15	Al	1	20

CERRADURA ANTIPÁNICO PALANCA DESLIZANTE ENTRE EJES 85 mm

SERIE 615E alupanic



CARACTERÍSTICAS

- Cerradura antipánico para puertas de aluminio y metálicas
- Sistema antipánico reversible
- Frente inox de 22 mm
- Picaporte reversible de 11 mm
- Picaporte regulable, excepto en entrada de 25 mm
- Caja de 15 mm
- Cuadradillo de 8 mm
- Operado mediante llave y manilla desde el exterior. La llave bloquea o desbloquea la manilla
- Tornillo de fijación de cilindro

ACCESORIOS OPCIONALES

- Gama completa de cerraderos (ver páginas 39 - 45)
- Gama completa de cilindros (ver páginas 119 - 140)

DESCRIPCIÓN

REF.

MEDIDAS
B A

LEVA

ACABADOS
FRENTE CANTO

UDS



- Picaporte y palanca
- Cilindro no incluido

- Opciones de cerradero (ver páginas 39 - 45)
- Opciones de cerradero eléctrico (ver página 46)

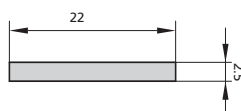

615E/25/6	22	37	15	Al	1	20
615E/30/6	27	42	15	Al	1	20
615E/35/6	32	47	15	Al	1	20

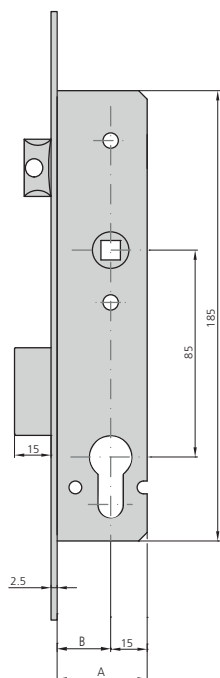

CERRADURA ANTIPÁNICO PALANCA DESLIZANTE ENTRE EJES 92 mm

SERIE 612 alupanic



CARACTERÍSTICAS

- Cerradura antipánico para puertas de aluminio y metálicas
- Sistema antipánico reversible
- Frente inox de 22 mm
- Picaporte reversible de 11 mm
- Picaporte regulable, excepto en entrada de 25 mm
- Caja de 15 mm
- Cuadradillo de 8 mm
- Operado mediante llave y pomo o manilla desde el exterior
- Tornillo de fijación de cilindro

ACCESORIOS OPCIONALES

- Gama completa de cerraderos (ver páginas 39 - 45)
- Gama completa de cilindros (ver páginas 119 - 140)

DESCRIPCIÓN	REF.	MEDIDAS		LEVA	ACABADOS		UDS
		B	A		FRENTE	CANTO	

NUECA PARTIDA

- Opciones de cerradero (ver páginas 39 - 45)
- Opciones de cerradero eléctrico (ver página 49)

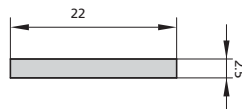
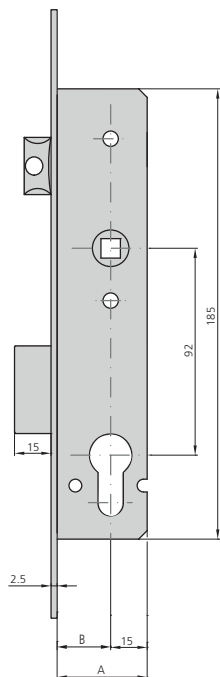

612/25/6	22	37	15	Al	1	20
612/30/6	27	42	15	Al	1	20
612/35/6	32	47	15	Al	1	20

NUECA PASANTE

- Picaporte y palanca
- Cilindro no incluido

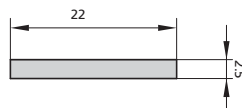

612P25/6	22	37	15	Al	1	20
612P30/6	27	42	15	Al	1	20
612P35/6	32	47	15	Al	1	20

CERRADURA ANTIPÁNICO PALANCA DESLIZANTE ENTRE EJES 92 mm

SERIE 612E alupanic



CARACTERÍSTICAS

- Cerradura antipánico para puertas de aluminio y metálicas
- Sistema antipánico reversible
- Frente inox de 22 mm
- Picaporte reversible de 11 mm
- Picaporte regulable, excepto en entrada de 25 mm
- Caja de 15 mm
- Cuadradillo de 8 mm
- Operado mediante llave y manilla desde el exterior. La llave bloquea o desbloquea la manilla
- Tornillo de fijación de cilindro

ACCESORIOS OPCIONALES

- Gama completa de cerraderos (ver páginas 39 - 45)
- Gama completa de cilindros (ver páginas 119 - 140)

DESCRIPCIÓN

REF.

MEDIDAS
B A

LEVA

ACABADOS
FRENTE CANTO

UDS



- Picaporte y palanca
- Cilindro no incluido

- Opciones de cerradero (ver páginas 39 - 45)
- Opciones de cerradero eléctrico (ver página 46)

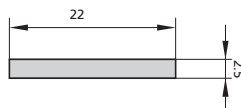

612E/25/6	22	37	15	Al	1	20
612E/30/6	27	42	15	Al	1	20
612E/35/6	32	47	15	Al	1	20

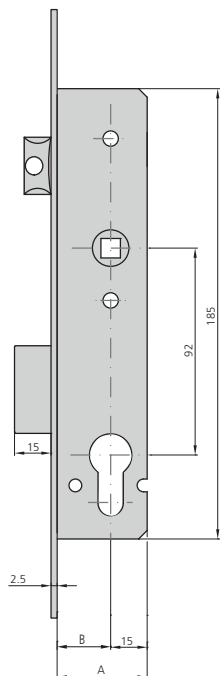

CERRADURA CON CERTIFICADO EN12209

SERIE 400

CARACTERÍSTICAS

ACCESORIOS OPCIONALES

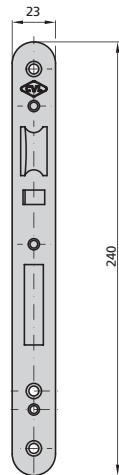

- Certificado según norma europea EN12209
- Frente en acero inoxidable en canto redondo o cuadrado
- Caja niquelada
- Cuadradillo de 8 mm
- Resbalón de hierro
- Tornillo de fijación de cilindro
- Cerradero de acero inoxidable en canto redondo o cuadrado
- Cerradura cortafuego

- Gama completa de cilindros (ver páginas 119 - 140)



DESCRIPCIÓN	REF.	MEDIDAS		LEVA	ACABADOS		UDS	
		B	A		FRENTE	CANTO		

- Cerradura con picaporte y palanca rectangular
- Cerradura con función antitarjeta

400L60/6HP	60	90	S. CIL	Al	Red	1	12
401L60/6HP	60	90	S. CIL	Al	Cua	1	12

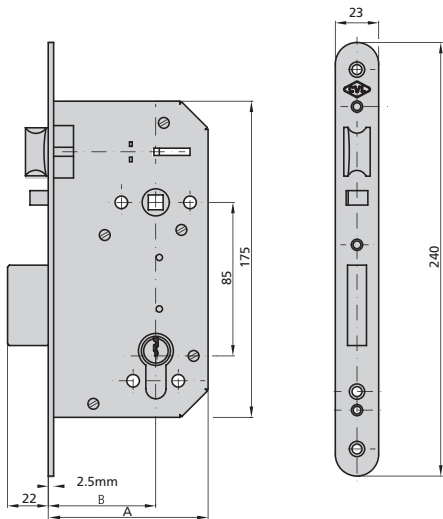

- Cerradura con picaporte y palanca rectangular

400/50/6HP	50	80	S. CIL	Al	Red	1	12
401/50/6HP	50	80	S. CIL	Al	Cua	1	12
400/60/6HP	60	90	S. CIL	Al	Red	1	12
401/60/6HP	60	90	S. CIL	Al	Cua	1	12

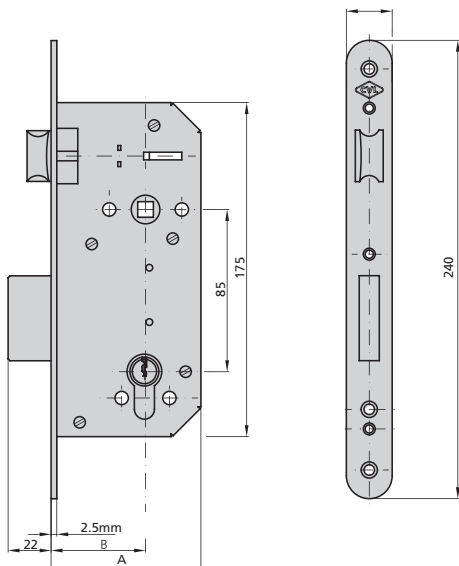

CERRADURA CON CERTIFICADO EN12209

SERIE 400T

CARACTERÍSTICAS

- Certificado según norma europea EN12209
- Frente en acero inoxidable en canto redondo o cuadrado
- Caja niquelada
- Cuadradillo de 8 mm
- Resbalón de hierro
- Tornillo de fijación de cilindro
- Cerradero de acero inoxidable en canto redondo o cuadrado
- Cerradura cortafuego

ACCESORIOS OPCIONALES

- Gama completa de cilindros (ver páginas 119 - 140)

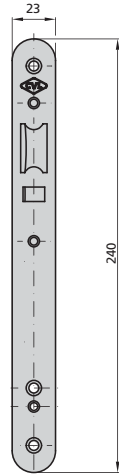

DESCRIPCIÓN	REF.	MEDIDAS		LEVA	ACABADOS		UDS	
		B	A		FRENTE	CANTO		

- Cerradura con sólo picaporte de acero
- Cerradura con función antitarjeta

400LT60/6H	60	90	S. CIL	Al	Red	1	12
401LT60/6H	60	90	S. CIL	Al	Cua	1	12

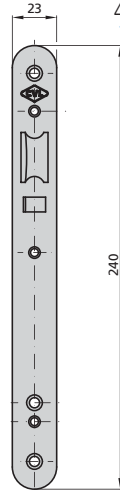
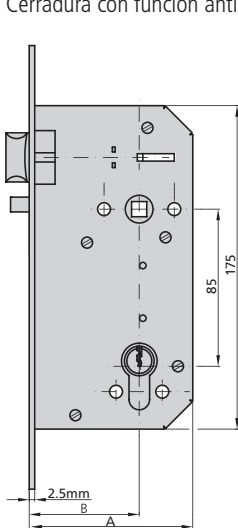

- Cerradura con solo picaporte de acero

400T50/6H	50	80	S. CIL	Al	Red	1	12
401T50/6H	50	80	S. CIL	Al	Cua	1	12
400T60/6H	60	90	S. CIL	Al	Red	1	12
401T60/6H	60	90	S. CIL	Al	Cua	1	12

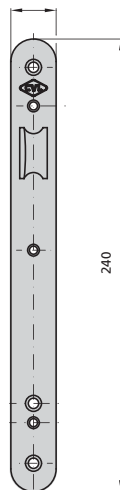
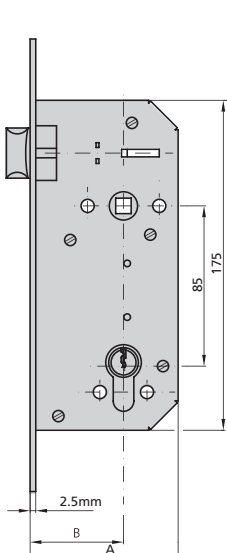

CERRADURA CORTAFUEGO Y ANTIPÁNICO CON MARCADO CE

SERIE 410

CARACTERÍSTICAS

- Cerradura cortafuego con función antipánico
- Certificado según norma europea EN 12209
- Certificado según norma europea EN179 con manilla JM5006
- Frente de acero inoxidable en canto redondo o cuadrado
- Caja niquelada
- Cuadradillo de 8 mm
- Cerraderos de acero inoxidable en canto redondo o cuadrado
- Tornillo de fijación de cilindro



ACCESORIOS OPCIONALES

- Gama completa de cilindros (ver páginas 119 - 140)



DESCRIPCIÓN	REF.	MEDIDAS		LEVA	ACABADOS		UDS	UDS
		B	A		FRENTE	CANTO		

• Cerradura con picaporte y palanca rectangular	410L60D/6HP	60	90	S. CIL	Al	Red	1	12
• Cerradura con función antitarjeta	410L60I/6HP	60	90	S. CIL	Al	Red	1	12
• Cerradura con función antipánico	411L60D/6HP	60	90	S. CIL	Al	Cua	1	12
• Cerradura con nueca partida	411L60I/6HP	60	90	S. CIL	Al	Cua	1	12

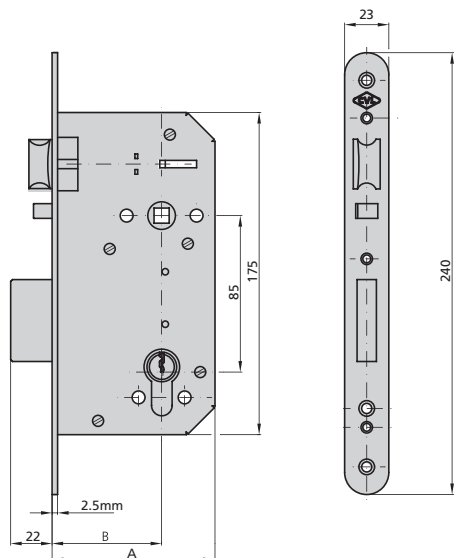

CERRADURA CORTAFUEGO Y ANTIPÁNICO CON MARCADO CE

SERIE 410

DESCRIPCIÓN	REF.	MEDIDAS		LEVA	ACABADOS		UDS	
		B	A		FRENTE	CANTO		
• Cerradura con picaporte y palanca	410/50D/6HP	50	80	S. CIL	Al	Red	1	12
• Cerradura con función antipánico	410/50I/6HP	50	80	S. CIL	Al	Red	1	12
• Cerradura con nueca partida	411/50D/6HP	50	80	S. CIL	Al	Cua	1	12
	411/50I/6HP	50	80	S. CIL	Al	Cua	1	12
	410/60D/6HP	60	90	S. CIL	Al	Red	1	12
	410/60I/6HP	60	90	S. CIL	Al	Red	1	12
	411/60D/6HP	60	90	S. CIL	Al	Cua	1	12
	411/60I/6HP	60	90	S. CIL	Al	Cua	1	12

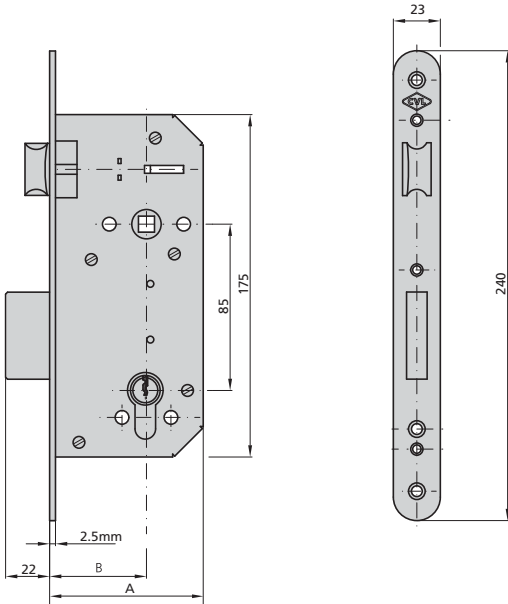

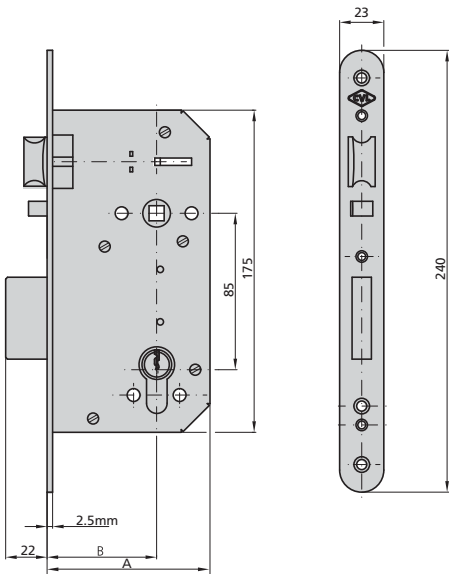

- Cerradura con picaporte y palanca rectangular
- Cerradura con función antitarjeta
- Cerradura con función antipánico
- Cerradura con nueca pasante

410L60/6HP	60	90	S. CIL	Al	Red	1	12
411L60/6HP	60	90	S. CIL	Al	Cua	1	12



CERRADURA CORTAFUEGO Y ANTIPÁNICO CON MARCADO CE

SERIE 410

DESCRIPCIÓN	REF.	MEDIDAS		LEVA	ACABADOS		UDS	
		B	A		FRENTE	CANTO		
• Cerradura con picaporte y palanca	410/50/6HP	50	80	S. CIL	Al	Red	1	12
• Cerradura con función antipánico	411/50/6HP	50	80	S. CIL	Al	Cua	1	12
• Cerradura con nueca pasante	410/60/6HP	60	90	S. CIL	Al	Red	1	12
	411/60/6HP	60	90	S. CIL	Al	Cua	1	12

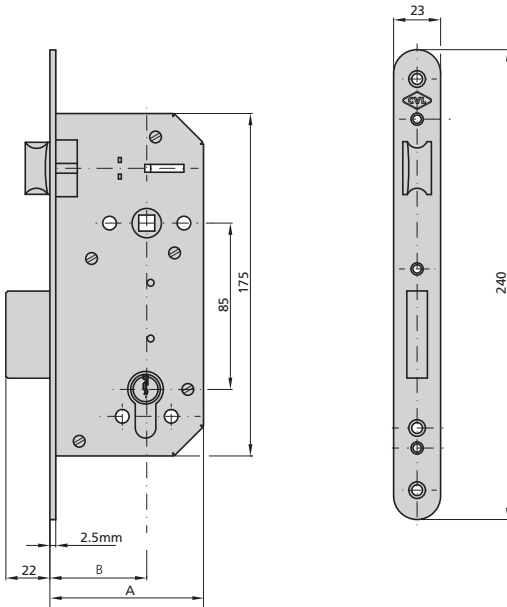

CERRADURA ANTIPÁNICO

SERIE 3000

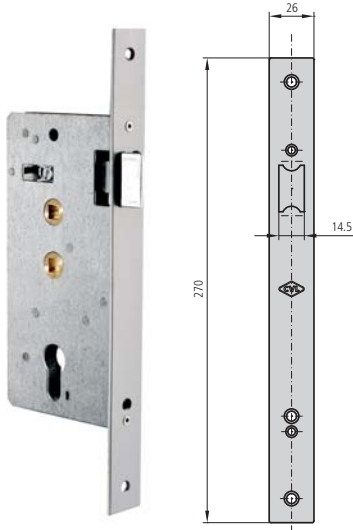

CARACTERÍSTICAS

- Cerradura antipánico
- Frente en acero
- Cuadradillo de 8 mm
- Tornillo de fijación de cilindro
- Cerradero según cerradura
- Cilindro 5982/2535/3

ACCESORIOS OPCIONALES

- Gama completa de cilindros (ver páginas 119 - 140)

DESCRIPCIÓN	REF.	MEDIDAS		LEVA	ACABADOS		UDS	
		B	A		FRENTE	CANTO		

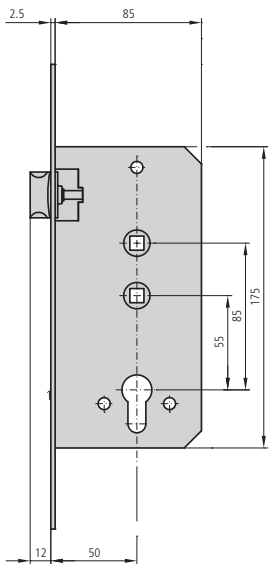

- Accionamiento exterior de manilla condenable mediante cilindro
- Picaporte de acero reversible

3005/6	50	88	15	AI	CL	1	12
--------	----	----	----	----	----	---	----

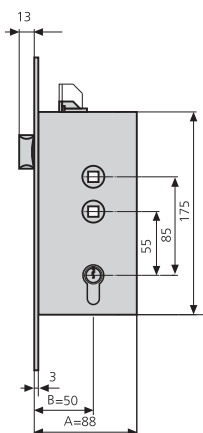

- Accionamiento exterior de manilla condenable mediante cilindro
- 2 puntos de cierre

3000AD	50	88	15	HE	CL	1	12
3000AI	50	88	15	HE	CL	1	12

CERRADURA ANTIPÁNICO

SERIE 3000

DESCRIPCIÓN	REF.	MEDIDAS		LEVA	ACABADOS		UDS	
		B	A		FRENTE	CANTO		

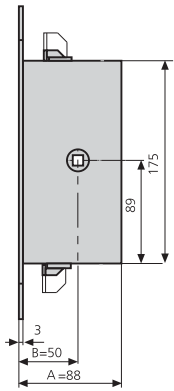

- Cerradura-cremona para hoja pasiva
- 2 puntos de cierre

3001	50	88	HE	1	12
------	----	----	----	---	----

CERRADURAS ELECTROMAGNÉTICAS

DESCRIPCIÓN	REF.	FUERZA DE RETENCIÓN	UDS
<ul style="list-style-type: none"> Cerradura electromagnética de empotrar Medidas electroimán 228x39x26 	VENM1	3000N	1
<ul style="list-style-type: none"> Cerradura electromagnética de sobreponer Medidas electroimán 273x66x40 	VENM2	5000N	1
<ul style="list-style-type: none"> Cerradura electromagnética de sobreponer Medidas electroimán 254x43x25 	VENM3	3000N	1
<ul style="list-style-type: none"> Cerradura electromagnética de empotrar para puertas de vaivén Medidas electroimán 165x31x21,5 	VENM554	7500N	1

ACCESORIOS ESCUDOS Y MANILLAS DE ACERO INOXIDABLE



CARACTERÍSTICAS

- Manillas de acero inoxidable certificadas en procedimientos de ensayo de la norma EN 179

DESCRIPCIÓN	REF.	ACABADO	CANTO	UDS
<ul style="list-style-type: none"> Escudo con manilla y bocallave cilindro Entre ejes 55 mm Cilindro no incluido 	CM5006I55/6R CM5006D55/6R	AI AI	Red Red	1 1
<ul style="list-style-type: none"> Escudo con manilla y bocallave cilindro Entre ejes 72 mm Cilindro no incluido 	CM5006I72/6R CM5006D72/6R	AI AI	Red Red	1 1
<ul style="list-style-type: none"> Escudo con manilla y bocallave cilindro Entre ejes 85 mm Cilindro no incluido 	CM5006I85/6R CM5006D85/6R	AI AI	Red Red	1 1
<ul style="list-style-type: none"> Escudo con manilla 	CM5007I6R CM5007D6R	AI AI	Red Red	1 1

ACCESORIOS **ESCUDOS Y MANILLAS EN NEGRO**

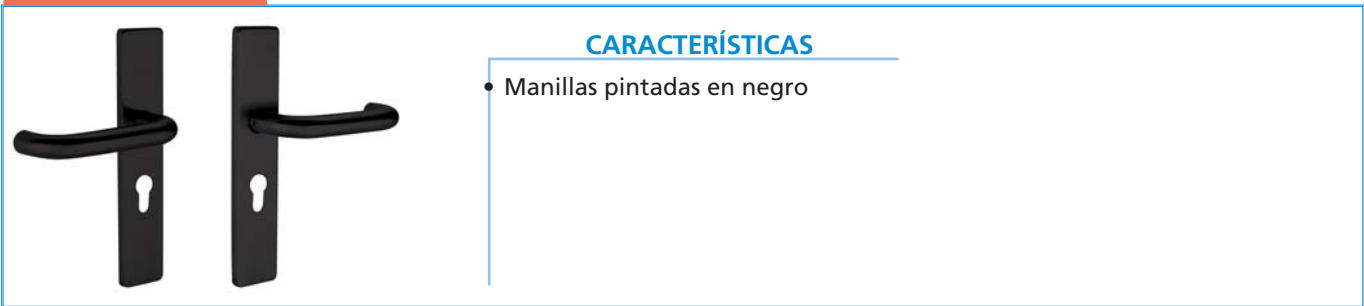

CARACTERÍSTICAS

- Manillas pintadas en negro

DESCRIPCIÓN	REF.	ACABADO	CANTO	UDS
-------------	------	---------	-------	-----

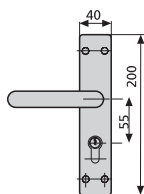

- Escudo con manilla y bocallave cilindro
- Entre ejes 55 mm
- Incluye cilindro B5000

M5000/1N	Negro	Cua	1
----------	-------	-----	---

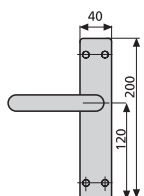

- Escudo con manilla

M5001/1N	Negro	Cua	1
----------	-------	-----	---

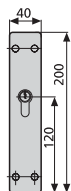

- Escudo con bocallave cilindro
- Entre ejes 55 mm
- Incluye cilindro B5000

M5002/1N	Negro	Cua	1
----------	-------	-----	---

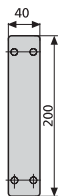

- Escudo ciego

M5003/1N	Negro	Cua	1
----------	-------	-----	---

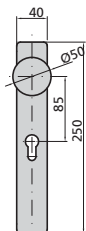

- Escudo con tirador y bocallave
- Incluye cilindro B5000

M5004/1N	Negro	Cua	1
----------	-------	-----	---

ACCESORIOS **CILINDROS Y OTROS ACCESORIOS**

DESCRIPCIÓN	REF.	ACABADO	UDS
-------------	------	---------	-----

• Cilindro para barra antipánico

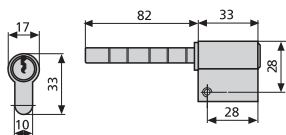

B5000	CL	1
B5000/4	CN	1

DESCRIPCIÓN	REF.	ACABADO
-------------	------	---------

• Barra de apoyo Ø25*1000 mm	BAR5000/6	Al
• Barra de apoyo Ø25*1500 mm	BAR5000/6E	Al
• Barra de apoyo Ø25*1000 mm	BAR5000/1R	HE rojo
• Barra de apoyo Ø25*1500 mm	BAR5000/1RE	HE rojo
• Tubo falleba Ø12*1000 mm	TUF6000/6	Al
• Tubo falleba Ø12*1500 mm	TUF6000/6E	Al
• Tubo falleba Ø12*1000 mm	TUF6000/1N	HE negro
• Tubo falleba Ø12*1500	TUF6000/1NE	HE negro
• Cerradero lateral	CE5000/1N	HE negro
• Cerradero lateral	CE5000/6	Al
• Cerradero bajo	CEB6000/1N	Acero microfundido negro
• Cerradero bajo	CEB6000	Acero microfundido

CONTROL DE ACCESOS

	Palanca deslizante entre ejes 85 mm	162
	• Serie ID1 inDeco	162
	Kit lector de proximidad MIFARE	163
	• Control de acceso autónomo	163
	Escudo electrónico de proximidad	164
	• Control de acceso autónomo	164

PALANCA DESLIZANTE ENTRE EJES 85 mm. SERIE ID1 inDeco

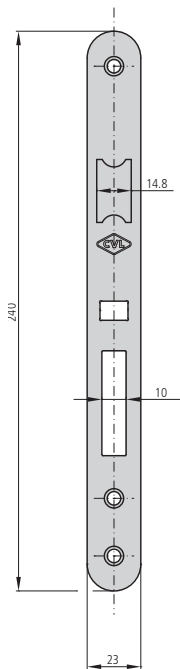

CARACTERÍSTICAS

- Cerradura de 1 punto de cierre con frente inox de 23 mm en canto redondo
- Picaporte reversible de acero
- Incluye función antitarjeta
- Palanca de acero de 21 mm de salida
- Cierre automático de la palanca al cerrar la puerta
- Inteligencia invisible: sistema electromecánico integrado en la cerradura habilitando la manilla exterior mediante un accionamiento eléctrico
- Función antipánico desde el interior
- Función antipánico reversible
- Cerradura preparada para atado normalizado de manillas y rosetas
- Incluye CPU con batería
- Incluye cerradero CEID1/6D y CEID1/6I
- Tornillo de fijación de cilindro
- Componentes de sujeción

ACCESORIOS OPCIONALES

- Medio cilindro
- Lector de proximidad

DESCRIPCIÓN	REF.	MEDIDAS		LEVA	ACABADOS		UDS	
		B	A		FRENTE	CILINDRO		
<ul style="list-style-type: none"> • Picaporte y palanca • Cilindro no incluido 	ID1/60/6R	90	60	15	Al		1	

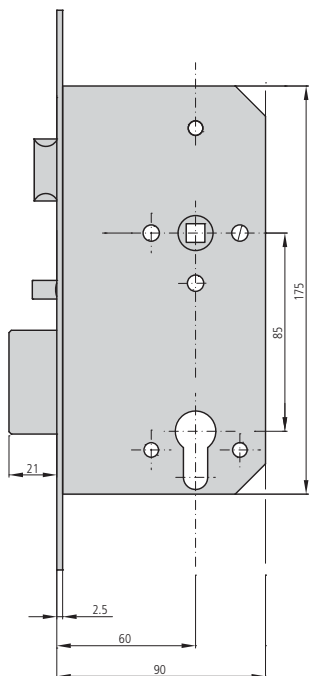

KIT LECTOR DE PROXIMIDAD MIFARE



CONTROL DE ACCESO AUTÓNOMO



CARACTERÍSTICAS

- Kit control de acceso
- Apertura con tarjeta de proximidad
- Listo para utilizar:
 - Tarjetas y lector configurados desde fábrica
 - Sin necesidad de software
- Posibilidades amplias de amaestramiento
- Tecnología Network on Card
- Conectable a cerradura eléctrica DUE, o cerraderos eléctricos
- CPU HS/C
- Tarjetas Mifare configuradas

ACCESORIOS OPCIONALES

DESCRIPCIÓN	REF.	MEDIDAS		LEVA	ACABADOS		UDS	
		B	A		FRENTE	CILINDRO		
 <ul style="list-style-type: none"> • Lector de proximidad R/W i/BUTTON 	14154000						1	
<ul style="list-style-type: none"> • CPU AHS 	14150000						1	
<ul style="list-style-type: none"> • Tarjeta MIFARE 1K numerada 	13718000						1	



ESCUDO ELECTRÓNICO DE PROXIMIDAD CONTROL DE ACCESO AUTÓNOMO



CARACTERÍSTICAS

- Sistema de control de acceso autónomo con lector integrado
- Apertura con tarjeta de proximidad
- Listo para utilizar:
 - Tarjetas y lector configurados desde fábrica
 - Sin necesidad de software
 - Sin necesidad de cableado (alimentación por pilas)
- Posibilidades amplias de amaestramiento
- Tecnología Network on Card
- Escudo inox de anchura de 30 mm adaptable a carpintería de aluminio
- Tarjetas Mifare configuradas

ACCESORIOS OPCIONALES

- Cerradura 410 o 410L

DESCRIPCIÓN	REF.	MEDIDAS B A	LEVA	ACABADOS FRENTE CILINDRO	UDS
-------------	------	----------------	------	-----------------------------	-----

• Escudo electrónico de proximidad

1404X000-Y

1



• Tarjeta MIFARE 1K numerada

13718000

1





VARIOS

Otros precios	166
• Seguridad	166
Condiciones de venta	167



OTROS PRECIOS

LLAVE SERRETA

DESCRIPCIÓN

- Cilindro largo especial
- Maestramiento. 1 lado
- Maestramiento. 2 lados
- Gran Maestra. Un lado
- Gran Maestra. Dos lados
- Cilindro con llaves iguales
- Cilindro con llaves según muestra

- Llave suplementaria (125)
- Llave sin mecanizar (125)
- Llave mecanizada según muestra (125)
- Llave gorja suplementaria (63R)
- Llave gorja (63R)

- Reductor metálico

- Rgo. alargamiento de cilindro (60, 70, 80 mm) cerradura sobreponer
- Rgo. alargamiento de cilindro (90, 100, 110 mm) cerradura sobreponer

- Rgo. configuración tarjeta Mifare

- Rgo. frente 2300 mm

- Rgo. frente 1500 mm

OTROS PRECIOS

SEGURIDAD

DESCRIPCIÓN

- Maestramiento. 1 lado
- Maestramiento. 2 lados
- Llave suplementaria
- Llave sin mecanizar
- Llave mecanizada según muestra
- Cilindro con llaves iguales
- Cilindro con llaves según muestra



Sistemas Valle Léniz S.L.U. • Pol. Arbi Zelai • Apdo 6, 20550 • Aretxabaleta • Gipuzkoa (Spain)
Tel: 943 79 10 16 • Fax: 943 79 25 46 • E-mail: cvl@cvl.es • Web: www.cvl.es