



aluminio

Aluminium

JGO MANILLA ALUMINIO 6800

Aluminium handle 6800

	código	acabado	medida	contenido	embalaje	8431488
	Nº					
ean13	68000	blanco	120 mm		1/10	680002
	68001	negro	120 mm		1/10	680019
	68002	plata	120 mm		1/10	680026
blister	17080	blanco	120 mm	1	8	170800
	17081	negro	120 mm	1	8	170817
	17082	plata	120 mm	1	8	170824

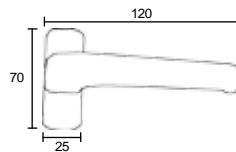

JGO MANILLA ALUMINIO 6802

Aluminium handle 6802

	código	acabado	medida	contenido	embalaje	8431488
	Nº					
ean13	68009	blanco	120 mm		1/4	680095
	68010	negro	120 mm		1/4	680101
	68011	plata	120 mm		1/4	680118
blister	17083	blanco	120 mm	1	8	170831
	17084	negro	120 mm	1	8	170848
	17085	plata	120 mm	1	8	170855

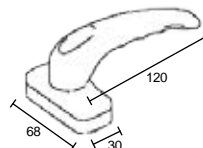

CIERRE PRESIÓN 6801

Latch 6801

	código	acabado	mano	contenido	embalaje	8431488	
	Nº						
ean13	68003	blanco	derecha		2/4	680033	
	68004	blanco	izquierda		2/4	680040	
	68005	negro	derecha		2/4	680057	
	68006	negro	izquierda		2/4	680064	
	68007	plata	derecha		2/4	680071	
	68008	plata	izquierda		2/4	680088	
	blister	17086	blanco	derecha	1	8	170862
		17087	blanco	izquierda	1	8	170879
17088		negro	derecha	1	8	170886	
17089		negro	izquierda	1	8	170893	
17090		plata	derecha	1	8	170909	
17091		plata	izquierda	1	8	170916	

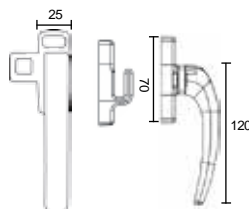

CIERRE PRESIÓN 6805

Latch 6805

	código	acabado	medida	contenido	embalaje	8431488
	Nº					
ean13	68045	blanco	derecha		1/4	680453
	68046	blanco	izquierda		1/4	680460
	68047	negro	derecha		1/4	680477
	68048	negro	izquierda		1/4	680484
	68049	plata	derecha		1/4	680491
	68050	plata	izquierda		1/4	680507
blister	17092	blanco	derecha	1	8	170923
	17093	blanco	izquierda	1	8	170930
	17094	negro	derecha	1	8	170947
	17095	negro	izquierda	1	8	170954
	17096	plata	derecha	1	8	170961
	17097	plata	izquierda	1	8	170978

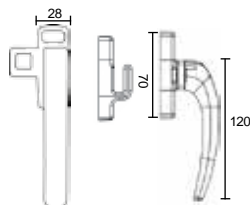

Aluminium

JGO MANILLA ALUMINIO 702

Aluminium handle 702

	código	acabado	medida	contenido	embalaje	8431488
	Nº					
ean13	68122	blanco	120 mm		1/5	681221
	68123	negro	120 mm		1/5	681238
	68124	plata	120 mm		1/5	681245
blister	17098	blanco	120 mm	1	8	170985
	17099	negro	120 mm	1	8	170992
	17100	plata	120 mm	1	8	171005

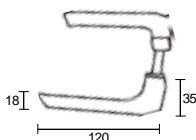

JGO MANILLA ALUMINIO 6824

Aluminium handle 6824

	código	acabado	medida	contenido	embalaje	8431488
	Nº					
caja	68069	blanco	225X29 mm		1	680699
	68070	negro	225x29 mm		1	680705
blister	17101	blanco	225x29 mm	1	8	171012
	17102	negro	225x29 mm	1	8	171029

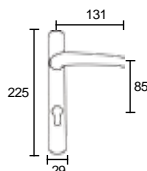

POMO RECUPERABLE ALUMINIO 6807

Recuperative aluminium knobs 6807

	código	acabado	medida	contenido	embalaje	8431488
	Nº					
caja	68012	blanco	70x29 mm		1/10	680125
	68013	negro	70x29 mm		1/10	680132
	68014	plata	70x29 mm		1/10	680149
blister	17103	blanco	70x29 mm	1	8	171036
	17104	negro	70x29 mm	1	8	171043
	17105	plata	70x29 mm	1	8	171050

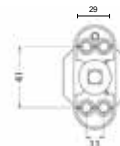
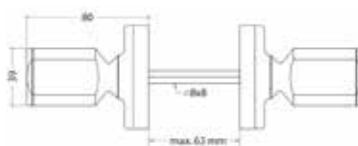

ASA ALUMINIO 6804

Aluminum handle 6804

	código	acabado	medida	contenido	embalaje	8431488
	Nº					
ean13	68018	blanco	200 mm		1/5	680187
	68019	negro	200 mm		1/5	680194
	68020	plata	200 mm		1/5	680200
blister	17106	blanco	200 mm	2	8	171067
	17107	negro	200 mm	2	8	171074
	17108	plata	200 mm	2	8	171081

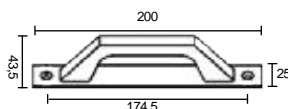

ASA ALUMINIO 6803

Aluminum handle 6803

	código	acabado	medida	contenido	embalaje	8431488
	Nº					
ean13	68015	blanco	200 mm		1/5	680156
	68016	negro	200 mm		1/5	680163
	68017	plata	200 mm		1/5	680170
blister	17109	blanco	200 mm	2	8	171098
	17110	negro	200 mm	2	8	171104
	17111	plata	200 mm	2	8	171111



ASA CIERRE ALUMINIO 6809

Aluminum handle 6809

	código	acabado	medida	contenido	embalaje	8431488
	Nº					
ean13	68024	blanco	173x25 mm		1/5	680248
	68025	negro	173x25 mm		1/5	680255
	68026	plata	173x25 mm		1/5	680262

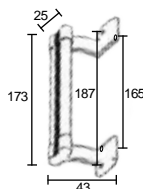

BOCALLAVE 6811

Keyhole 6811

	código	acabado	medida	contenido	embalaje	8431488
	Nº					
caja	68021	blanco	70x30 mm		10	680217
	68022	negro	70x30 mm		10	680224
blister	91460	blanco	70x30 mm	2	10	914602
	91461	negro	70x30 mm	2	10	914619

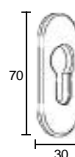

Aluminium

PASADOR ALUMINIO D8

Aluminum bolt D8

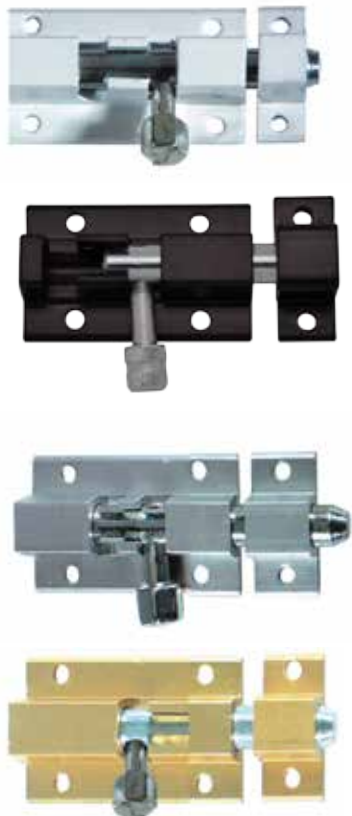

código	acabado	medida	contenido	embalaje	8431488
Nº		A			
63205	blanco	50 mm		20	632056
63207	blanco	75 mm		20	632070
63210	blanco	100 mm		20	632100
63215	blanco	150 mm		10	632155
63220	blanco	200 mm		10	632209
63225	blanco	250 mm		10	632254
63230	blanco	300 mm		10	632308
63240	blanco	400 mm		10	632407
63247	negro	50 mm		20	632476
63248	negro	75 mm		20	632483
63249	negro	100 mm		20	632490
63250	negro	150 mm		10	632506
63251	negro	200 mm		10	632513
63252	negro	250 mm		10	632520
63253	negro	300 mm		10	632537
caja 63254	negro	400 mm		10	632544
63305	plata	50 mm		20	633053
63307	plata	75 mm		20	633077
63310	plata	100 mm		20	633107
63315	plata	150 mm		10	633152
63320	plata	200 mm		10	633206
63325	plata	250 mm		10	633251
63330	plata	300 mm		10	633305
63340	plata	400 mm		10	633404
63105	oro	50 mm		20	631059
63107	oro	75 mm		20	631073
63110	oro	100 mm		20	631103
63115	oro	150 mm		10	631158
63120	oro	200 mm		10	631202
63125	oro	250 mm		10	631257
63130	oro	300 mm		10	631301
63140	oro	400 mm		10	631400
90163	blanco	50 mm	1	10	901633
91545	blanco	75 mm	1	10	915456
90164	blanco	100 mm	1	10	901640
91546	negro	50 mm	1	10	915463
91547	negro	75 mm	1	10	915470
blistar 91697	negro	100 mm	1	10	916972
90165	plata	50 mm	1	10	901657
91548	plata	75 mm	1	10	915487
90166	plata	100 mm	1	10	901664
90161	oro	50 mm	1	10	901619
91549	oro	75 mm	1	10	915494
90162	oro	100 mm	1	10	901626

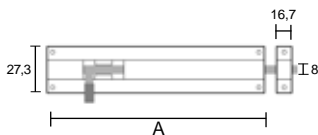

PASADOR RULETA ALUMINIO 6825

Aluminium bolt 6825

código	acabado	medida	contenido	embalaje	8431488
Nº					
ean13 68132	blanco	39,5x22 mm		1/10	681320
68133	negro	39,5x22 mm		1/10	681337
68134	plata	39,5x22 mm		1/10	681344
blistar 91462	blanco	39,5x22 mm	1	10	914626
91463	negro	39,5x22 mm	1	10	914633
91464	plata	39,5x22 mm	1	10	914640

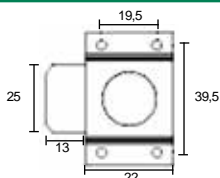

PASADOR ALUMINIO D12

Aluminum bolt D12

código	acabado	medida	contenido	embalaje		8431488
Nº		A				
63241	blanco	100 mm		1/10		632414
63242	blanco	150 mm		1/10		632421
63243	blanco	200 mm		1/5		632438
63244	blanco	250 mm		1/5		632445
63245	blanco	300 mm		1/5		632452
63246	blanco	400 mm		1/5		632469
63255	negro	100 mm		1/10		632551
63256	negro	150 mm		1/10		632568
63257	negro	200 mm		1/5		632575
63258	negro	250 mm		1/5		632582
63259	negro	300 mm		1/5		632599
63260	negro	400 mm		1/5		632605
63341	plata	100 mm		1/10		633411
63342	plata	150 mm		1/10		633428
63343	plata	200 mm		1/5		633435
63344	plata	250 mm		1/5		633442
63345	plata	300 mm		1/5		633459
63346	plata	400 mm		1/5		633466
63141	oro	100 mm		1/10		631417
63142	oro	150 mm		1/10		631424
63143	oro	200 mm		1/5		631431
63144	oro	250 mm		1/5		631448
63145	oro	300 mm		1/5		631455
63146	oro	400 mm		1/5		631462

caja

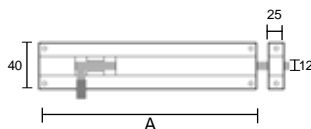

GOLPETE ALUMINIO 6810

Aluminum latch 6810

código	acabado	medida	contenido	embalaje		8431488
Nº						
68125	blanco	57x 21,8 mm		1/5		681252
68126	negro	57x 21,8 mm		1/5		681269
68127	plata	57x 21,8 mm		1/5		681276
91465	blanco	57x 21,8 mm	1	10		914657
91466	negro	57x 21,8 mm	1	10		914664
91467	plata	57x 21,8 mm	1	10		914671

ean13

blister

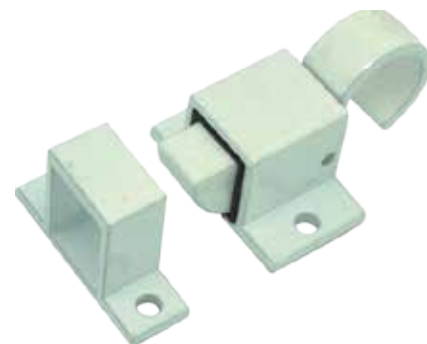
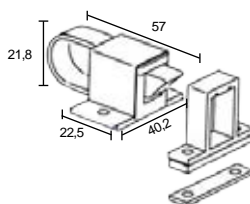

GOLPETE PERFIL EU ALUMINIO 6808

Aluminum latch 6808

código	acabado	medida	contenido	embalaje		8431488
Nº						
68027	blanco	61x25x40 mm		1/5		680279
68028	negro	61x25x40 mm		1/5		680286
68029	plata	61x25x40 mm		1/5		680293
91468	blanco	61x25x40 mm	1	10		914688
91469	negro	61x25x40 mm	1	10		914695
91470	plata	61x25x40 mm	1	10		914701

ean13

blister

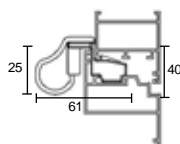

Aluminium



CIERRE CORREDERA ALUMINIO 6820

Aluminium sliding closure 6820

	código	acabado	medida	contenido	embalaje	8431488
	Nº					
ean13	68061	blanco	174x24 mm		2/10	680613
	68062	negro	174x24 mm		2/10	680620

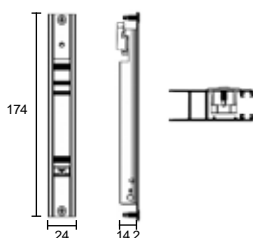

Incluye cerradero



CIERRE CORREDERA ALUMINIO 6821

Aluminium sliding closure 6821

	código	acabado	medida	contenido	embalaje	8431488
	Nº					
ean13	68063	blanco	174x24 mm		2/10	680637
	68064	negro	174x24 mm		2/10	680644

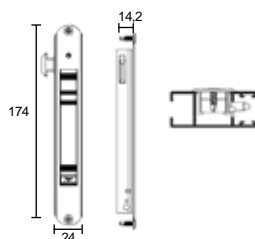

Incluye cerradero



CIERRE CORREDERA ALUMINIO 6822

Aluminium sliding closure 6822

	código	acabado	medida	contenido	embalaje	8431488
	Nº					
ean13	68065	blanco	174x24 mm		2/10	680651
	68066	negro	174x24 mm		2/10	680668

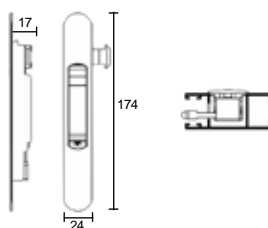

Incluye cerradero



CIERRE CORREDERA ALUMINIO 6823

Aluminium sliding closure 6823

	código	acabado	medida	contenido	embalaje		8431488
	Nº						
ean13	68067	blanco	174x24 mm		2/10		680675
	68068	negro	174x24 mm		2/10		680682

Incluye cerradero

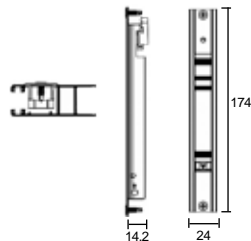

CIERRE CORREDERA LLAVES IGUALES 6826

Closing sliding equal keys 6826

	código	acabado	medida	contenido	embalaje		8431488
	Nº						
ean13	68135	blanco	120x38 mm		1/5		681351
	68136	negro	120x38 mm		1/5		681368

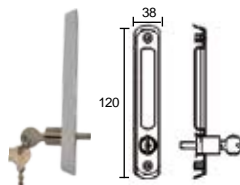

PROLONGADOR CIERRE CORREDERA

Closing sliding panel

	código	acabado	medida	contenido	embalaje		8431488
	Nº						
caja	68137	níquel	36 mm		10		681375

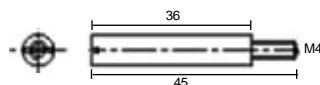



CONTRACIERRES 6819

Against closures 6819

	código	acabado	medida	contenido	embalaje	8431488
	Nº					
caja	68128	bicromatado	35 mm		25	681283
	68129	bicromatado	54 mm		25	681290
	68130	bicromatado	32 mm		25	681306
	68131	bicromatado	35 mm		25	681313
blister	91483	bicromatado	35 mm	2	10	914831
	91484	bicromatado	54 mm	2	10	914848
	91485	bicromatado	32 mm	2	10	914855
	91486	bicromatado	35 mm	2	10	914862

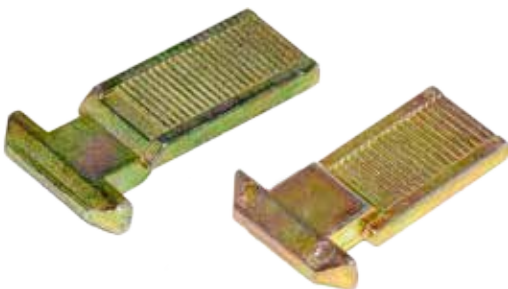
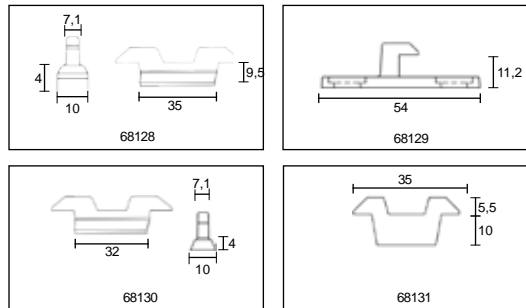

CERRADERO LENGÜETA 6818

Torque strike 6818

	código	acabado	medida	contenido	embalaje	8431488
	Nº					
caja	68059	bicromatado	30x20 mm		25	680590
	68060	bicromatado	36x20 mm		25	680606
blister	91487	bicromatado	30x20 mm	2	10	914879
	91488	bicromatado	36x20 mm	2	10	914886

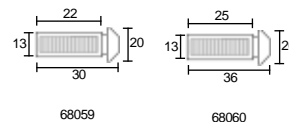

BISAGRA SERIE EUROPEA 6812

European series hinge 6812

	código	acabado	medida	contenido	embalaje	8431488
	Nº					
ean13	68033	blanco	100x21 mm. drcha		2/10	680330
	68034	blanco	100x21 mm. izda.		2/10	680347
	68035	negro	100x21 mm. drcha		2/10	680354
	68036	negro	100x21 mm. izda.		2/10	680361
	68037	plata	100x21 mm. drcha		2/10	680378
	68038	plata	100x21 mm. izda.		2/10	680385
blister	91471	blanco	100x21 mm. drcha	2	10	914718
	91472	blanco	100x21 mm. izda.	2	10	914725
	91473	negro	100x21 mm. drcha	2	10	914732
	91474	negro	100x21 mm. izda.	2	10	914749
	91475	plata	100x21 mm. drcha	2	10	914756
	91476	plata	100x21 mm. izda.	2	10	914763

Tornillos inox.



BISAGRA SERIE CONVENCIONAL 6813

Conventional series hinge 6813

	código	acabado	medida	contenido	embalaje	8431488
	Nº					
ean13	68039	blanco	100x21 mm. drcha		2/10	680392
	68040	blanco	100x21 mm. izda.		2/10	680408
	68041	negro	100x21 mm. drcha		2/10	680415
	68042	negro	100x21 mm. izda.		2/10	680422
	68043	plata	100x21 mm. drcha		2/10	680439
	68044	plata	100x21 mm. izda.		2/10	680446
blister	91477	blanco	100x21 mm. drcha	2	10	914770
	91478	blanco	100x21 mm. izda.	2	10	914787
	91479	negro	100x21 mm. drcha	2	10	914794
	91480	negro	100x21 mm. izda.	2	10	914800
	91481	plata	100x21 mm. drcha	2	10	914817
	91482	plata	100x21 mm. izda.	2	10	914824

Tornillos inox.

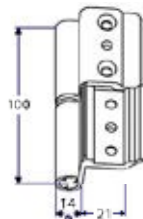

MANIVELA MULTIPUNTO ALUMINIO 6806

Aluminium multi point handle 6806

	código	acabado	cuadradillo	contenido	embalaje	8431488
	Nº					
ean13	68030	blanco	7 mm		1/4	680309
	68031	negro	7 mm		1/4	680316

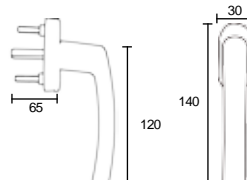



Aluminium



CREMONA ALUMINIO 6814

Aluminium handle 6814

código	acabado	medida	contenido	embalaje	8431488
Nº					
ean13	68051	blanco	160x29 mm	1/5	680514
	68052	negro	160x29 mm	1/5	680521

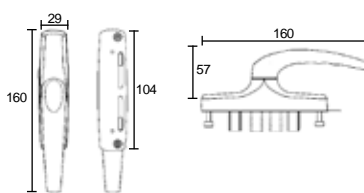

CREMONA ALUMINIO 6815

Aluminium handle 6815

código	acabado	medida	contenido	embalaje	8431488
Nº					
ean13	68053	blanco	173,5x34 mm	1/5	680538
	68054	negro	173,5x34 mm	1/5	680545

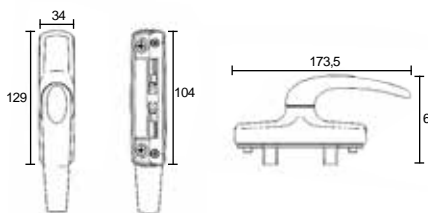

CREMONA ALUMINIO 6816

Aluminium handle 6816

	código	acabado	medida	contenido	embalaje	8431488
	Nº					
ean13	68055	blanco	170,5x25 mm		1/5	680552
	68056	negro	170,5x25 mm		1/5	680569

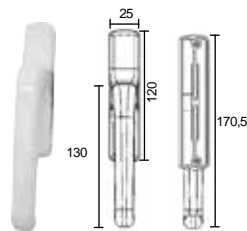

CREMONA ALUMINIO 6817

Aluminium cremona 6817

	código	acabado	medida	contenido	embalaje	8431488
	Nº					
ean13	68057	blanco	180x34 mm		1/5	680576
	68058	negro	180x34 mm		1/5	680583

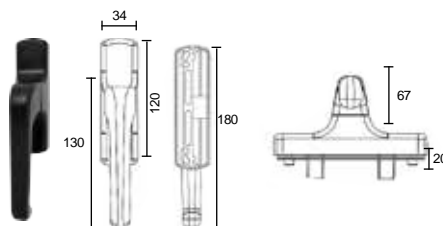



RETENEDOR VENTANA CLIP-1

Window retainer clip-1

	código	acabado	medida	contenido	embalaje	8431488
	Nº					
caja	30518	negro	101 mm		1/4	305189

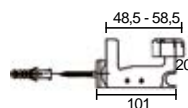
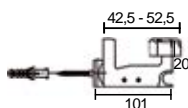

NE



RETENEDOR VENTANA CLIP-2

Window retainer clip-2

	código	acabado	medida	contenido	embalaje	8431488
	Nº					
caja	30519	negro	42x15 mm		10	305196

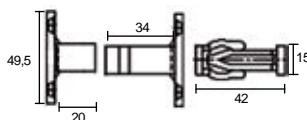

NE



RETENEDOR PUERTA CLIP-3

Door retainer clip-3

	código	acabado	medida	contenido	embalaje	8431488
	Nº					
caja	30520	negro	42x15 mm		10	305202

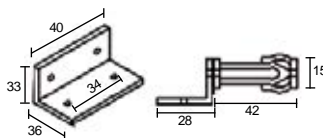

NE

RODAMIENTO NYLON 172

Nylon bearing 172

	código	acabado	medida	contenido	embalaje	8431488
	Nº					
caja	68207	nylon	37x25,5 mm		12	682075
blister	91334	nylon	37x25,5 mm	2	10	913346

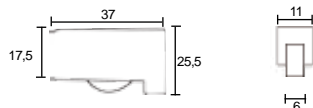

RODAMIENTO NYLON CO22

Nylon bearing CO22

	código	acabado	medida	contenido	embalaje	8431488
	Nº					
caja	68212	nylon	37x25,5 mm		12	682129
blister	91339	nylon	37x25,5 mm	2	10	913391

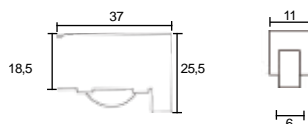

RODAMIENTO NYLON INASA 163

Nylon bearing Inasa 163

	código	acabado	medida	contenido	embalaje	8431488
	Nº					
caja	68206	nylon	40x33,5 mm		12	682068
blister	91333	nylon	40x33,5 mm	2	10	913339

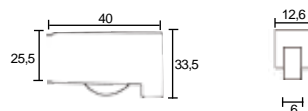

RODAMIENTO NYLON ENDASA CLL

Nylon bearing Endasa CLL

	código	acabado	medida	contenido	embalaje	8431488
	Nº					
caja	68208	nylon	33,5x15,5 mm		12	682082
blister	91335	nylon	33,5x15,5 mm	2	10	913353

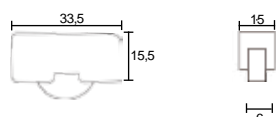



Aluminium



RODAMIENTO METÁLICO INASA 151

Metallic bearing Inasa 151

	código	acabado	medida	contenido	embalaje	8431488
	Nº					
caja	68200	acero	40,5x12,2 mm		12	682006
blister	91327	acero	40,5x12,2 mm	2	10	913278

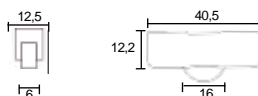

RODAMIENTO METÁLICO 157

Metallic bearing 157

	código	acabado	medida	contenido	embalaje	8431488
	Nº					
caja	68201	acero	40,5x20 mm		12	682013
blister	91328	acero	40,5x20 mm	2	10	913285

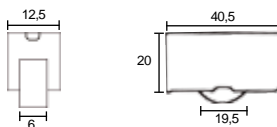

RODAMIENTO METÁLICO 158

Metallic bearing 158

	código	acabado	medida	contenido	embalaje	8431488
	Nº					
caja	68202	acero	40x20,2 mm		12	682020
blister	91329	acero	40x20,2 mm	2	10	913292

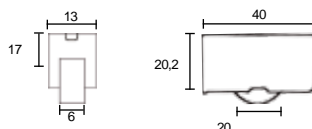

RODAMIENTO METÁLICO 158/S

Metallic bearing 158-S

	código	acabado	medida	contenido	embalaje	8431488
	Nº					
caja	68203	acero	40x20 mm	2	12	682037
blister	91330	acero	40x20 mm	2	10	913308

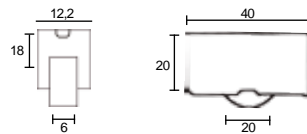

RODAMIENTO METÁLICO INASA 162

Metallic bearing Inasa 162

	código	acabado	medida	contenido	embalaje	8431488
	Nº					
caja	68204	acero	40x25,5 mm	2	12	682044
blister	91331	acero	40x25,5 mm	2	10	913315

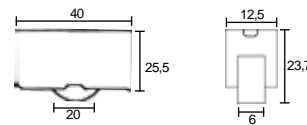

RODAMIENTO METÁLICO CLIMALIT 177

Metallic bearing Climalit 177

	código	acabado	medida	contenido	embalaje	8431488
	Nº					
caja	68205	acero	40,5x20 mm	2	12	682051
blister	91332	acero	40,5x20 mm	2	10	913322

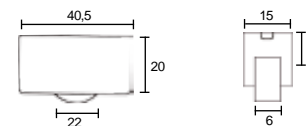



Aluminium



RODAMIENTO METÁLICO CLL/104

Metallic bearing CLL/104

	código	acabado	medida	contenido	embalaje	8431488
	Nº					
caja	68209	acero	45,2x15 mm		12	682099
blister	91336	acero	45,2x15 mm	2	10	913360

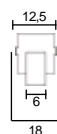
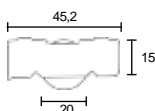

RODAMIENTO NYLON ALUGOM 400

Nylon bearing ALUGOM 400

	código	acabado	medida	contenido	embalaje	8431488
	Nº					
caja	68225	nylon	64x25 mm		12	682259
blister	91800	nylon	64x25 mm	2	10	918006

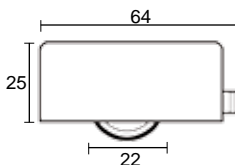

triple regulación



TORNILLO RODAMIENTO MAMPARA

Screw bearing screen

	código	acabado	medida	contenido	embalaje	8431488
	Nº					
caja	68213	inox	M4x8 mm		25	682136



INOX

RODAMIENTO MAMPARA C/TORNILLO

Bearing screen with screw

	código	acabado	medida	contenido	embalaje	8431488
	Nº					
caja	68221	negro	16 mm		25	682211
blister	91796	negro	16 mm	2	10	917962

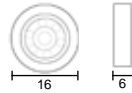

M3

RODAMIENTO MAMPARA C/TORNILLO

Bearing screen with screw

	código	acabado	medida	contenido	embalaje	8431488
	Nº					
caja	68210	negro	20 mm		25	682105
blister	91337	negro	20 mm	2	10	913377

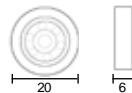

M4

RODAMIENTO MAMPARA C/TORNILLO

Bearing screen with screw

	código	acabado	medida	contenido	embalaje	8431488
	Nº					
caja	68211	negro	26 mm		25	682112
blister	91338	negro	26 mm	2	10	913384

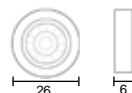

M4

Aluminium



M5

RODAMIENTO MAMPARA C/TORNILLO

Screen bearing

	código	acabado	medida	contenido	embalaje		8431488
	Nº						
caja	68222	blanco	22 mm		12		682228
blister	91797	blanco	22 mm	2	10		917979

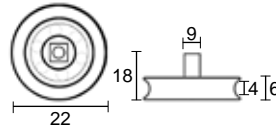

BL



M5

RODAMIENTO MAMPARA C/TORNILLO

Screen bearing

	código	acabado	medida	contenido	embalaje		8431488
	Nº						
caja	68223	blanco	24 mm		12		682235
blister	91798	blanco	24 mm	2	10		917986

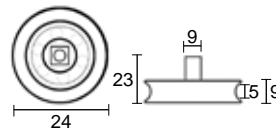

BL



M5

RODAMIENTO MAMPARA ARTICULADO C/TORNILLO

Screen bearing

	código	acabado	medida	contenido	embalaje		8431488
	Nº						
caja	68224	blanco	26 mm		12		682242
blister	91799	blanco	26 mm	2	10		917993

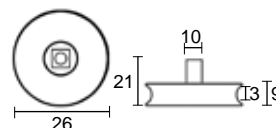

BL