



# AMB ALUMABE<sup>®</sup>

## ACCESORIOS Y HERRAJES ESPECIALES PARA CARPINTERÍAS DE ALUMINIO

# CATÁLOGO GENERAL



# AMB ALUMABE CASTELLANOS 2011, S.L.

## ACCESORIOS PARA CARPINTERÍAS DE ALUMINIO

Polígono Industrial de Trobajo  
C/ Artesiano, Parcela 68  
24010 Trobajo del Camino (León) España  
Tel. +34 987 26 26 23 - Fax +34 987 26 24 44  
www.alumabe.es  
alumabe@alumabe.es



## PERFIL DE LA EMPRESA

Alumabe es una empresa española creada en el año 1988 por M<sup>ª</sup> Beatriz Martínez y Gregorio Castellanos, y que se dedica al Diseño, Fabricación y Comercialización principalmente de Artículos Especiales para Carpinterías de Aluminio.

Nuestros clientes son Comerciales de Accesorios, Almacenes de Aluminio, Prensas de Extrusión, Suministros o Ferreterías Industriales, y cualquier otro Mayorista especializado en el sector de la Carpintería Metálica y el Bricolaje, tanto en el mercado nacional, como en el exterior.

Todos nuestros Artículos están fabricados preferentemente en Aluminio (mediante Extrusión, Fundición o Inyección), Plástico o Zamak, se caracterizan por su estudiado diseño y versatilidad, y facilitan al cerrajero o instalador la realización de sus trabajos de forma rápida, sencilla y económica, proporcionándole innovadoras soluciones de montaje.

En Alumabe nos caracterizamos por mantener unos elevados stocks, los cuales nos permiten un suministro totalmente inmediato de la gran mayoría de nuestros artículos.

Confiamos plenamente en nuestro Capital Humano, ya que hemos conseguido crear y coordinar un equipo de profesionales motivado y capacitado para gestionar soluciones eficientes.

Nuestra presencia en el mercado internacional es cada vez más requerida, y por ello estamos preparados para atenderles directamente en Inglés, Alemán, Francés o Italiano, lo cual agiliza nuestra capacidad operativa.

En Alumabe apostamos por invertir en I+D+I, lo que nos ayuda a evolucionar constantemente, adaptándonos a las exigencias del mercado y a las necesidades concretas de los clientes. Por ello, además de los muchos Artículos que figuran en Catálogo, fabricamos una gran variedad de piezas especiales y exclusivas.

Nuestro objetivo primordial es seguir contando con la confianza de nuestros clientes, con el fin de poder ofrecerles un servicio integral y eficaz, optimizado a sus necesidades.





Accesorios para Barandilla .....	4 a 13
Sistema "Colum-Perg" - Pérgolas y Columnas .....	14 a 16
Sistema "Pergosol" - Pérgolas de 120x120 .....	17
Pintura en Stick y Spray para Aluminio .....	18
Productos de Limpieza para el Aluminio y PVC .....	19
Selladores y Adhesivo de Contacto Instantáneo.....	20
Tubos Torneados de Aluminio y Accesorios .....	21
Sistema "Todo-Alum" - Tubo Reforzado, Macollas y Accesorios para Puertas .....	22 a 23
Accesorios en Acero Inox. para Puertas y Tiradores de Aluminio .....	24 a 25
Soportes Tirador y Multiadaptador de Aluminio.....	26 a 27
Chapas Estampadas de Aluminio .....	28 a 31
Rejillas de Ventilación de Aluminio .....	31
Chapas Fressalum .....	32
Paneles Fressalum .....	33
Paneles Estampados de Aluminio .....	34 a 35
Tapas Decorativas y Accesorios para Verjas .....	36 a 37
Chapa Trenzada de Aluminio "Trenzalum" .....	38
Manillas, Asas, Pomos, Muletilla y Pasador de Aluminio.....	39
Ojo de Buey de Aluminio para Puertas .....	40
Ojos de Buey "Ojalum" .....	41
Ojos de Buey "Giralum", "Intalum", "Fijalum" y "Abatalum" .....	42 a 43
Juego Compás Basculante y Juego Clipa-Compás .....	43
Cierrapuertas con Retención .....	44
Mirillas y Retenedor de Seguridad para Puertas de Entrada .....	45
Retenedores de Seguridad para Ventanas y Puertas de 1 ó 2 hojas .....	46 a 47
Artículos para Seguridad Infantil .....	48
Tope para Correderas y Juegos de Contacto .....	49
Accesorios de Plástico .....	50
Tapas de Plástico y Cubre Cabezas de Tornillos .....	51
Mecanismos y Accesorios para Mallorquinas .....	52
Retenedores para Mallorquinas .....	53
Tacos y Remates para Mallorquinas Fijas .....	54



## BASES DE ALUMINIO

Tubo exterior.  
No necesitan Embellecedor.  
La fijación al suelo se realiza desde el interior de la base.

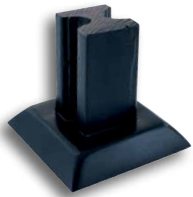

**30x30**

Ref: BA3030- (Sin Embellecedor)\*  
Ref: BA3030T- (Con Embellecedor)\*



**35x35**

Ref: BA3535- (Sin Embellecedor)\*



**40x40**

Ref: BA4040- (Sin Embellecedor)\*  
Ref: BA4040T- (Con Embellecedor)\*



**60x60** Ref: BA6060-\*

**70x70** Ref: BA7070-\*

**80x80** Ref: BA8080-\*

## MULTIBASES DE ALUMINIO

Cada Multibase sirve para 3 medidas de tubo. En el caso de tubos redondos, su colocación podrá ser interior o exterior, y en el caso del tubo cuadrado siempre será exterior.

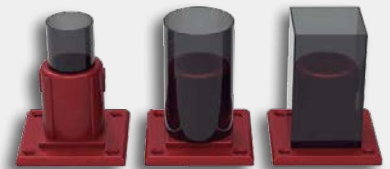

La Multibase Ø80 - Ø100 - 100x100 (MBA8010-) no necesita Embellecedor. La fijación al suelo se realiza desde el interior de la base.

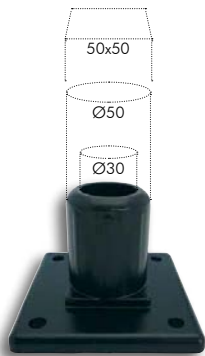

Multibase para  
**Ø30 - Ø50 - 50x50**  
Ref: MBA3050-\*

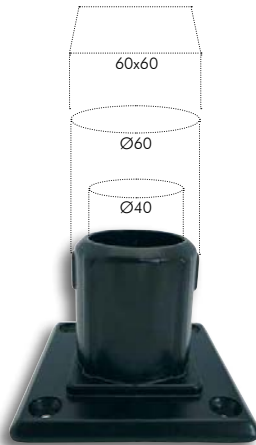

Multibase para  
**Ø40 - Ø60 - 60x60**  
Ref: MBA4060-\*



Multibase para  
**Ø80 - Ø100 - 100x100**  
Ref: MBA8010-\*

## EMBELLEDADORES DE ALUMINIO



Para Perfil  
**40x20** Ref: TABA4020-



Para Bases y Multibase  
**30x30** Ref: TABA3030-  
**40x40** Ref: TABA4040-  
**50x50** Ref: TABA5050-  
**60x60** Ref: TABA6060-



Para Perfil  
**70x70** Ref: TABA7070-  
**100x100** Ref: TABA100100-

## BASES DE ZAMAC



**Ø35**

Ref: BZRE35- (Sin Embellecedor)  
Ref: BTZRE35- (Con Embellecedor)



**30x30**

Ref: 9030\*



Para Base de Zamac  
**30x30**  
Ref: TABZ3030-

\* Piezas Certificadas por CIDEMCO-TECNALIA





## BASES DE ALUMINIO NIVELANTES CON CUÑA



**30x30**  
Ref: BNC3030N-\*



**40x20**  
Ref: BNC4020N-\*



**40x40**  
Ref: BNC4040N-\*



INCLUYEN TAPA  
CUBRE-CABEZA  
DE TORNILLOS



## BASES DE ALUMINIO



**30x30**  
Ref: 9330PRI\*



**40x20**  
Ref: 9420PRI\*



**40x40**  
Ref: 9440PRI\*



## BASES DE ALUMINIO DESPLAZA-BARANDILLAS

Permiten desplazar hacia el exterior la barandilla



**30x30**  
Ref: BDB3030-\*



**40x30**  
Ref: BDB4030-\*



**40x20**  
Ref: BDB4020-\*



## BASES DE ALUMINIO

POSIBILIDAD DE ACABADOS ANODIZADOS



**MOD. MILOS**  
**NIVELANTE 40x20**  
Ref: MILEX4020-



**MOD. NAXOS**  
**NIVELANTE 40x20**  
Ref: NAXNI4020-



**MOD. SIROS**  
**40x20**  
Ref: BEX4020-\*



**MOD. LEROS**  
**40x40**  
Ref: BEX4040-





## SOPORTES DE ALUMINIO PARA CRISTAL Y TUBO



**MOD. AZORES**  
**40x20**  
Ref: SCFI4020-\*

### FIJOS

#### "U" DE PLÁSTICO



Para Cristal 4+4  
Ref: SCU08\*



**MOD. MADEIRA**  
**30x30**  
Ref: SCFI3030-\*



**MOD. RODAS**  
**40x20**  
Ref: SC4020-\*



Para Cristal 6+6  
Ref: SCU12\*

### REGULABLES



**MOD. MALTA**  
**30x30**  
Ref: SC3030-\*



**MOD. CÓRCEGA**  
**40x20**  
Ref: SCEX4020-\*

### FIJOS

#### "U" DE PLÁSTICO



Para Cristal 4+4  
Ref: SCUEX08



**MOD. CERDEÑA**  
**40x40**  
Ref: SCEX4040-

POSIBILIDAD  
DE ACABADOS  
ANODIZADOS



**MOD. SICILIA**  
**40x20**  
Ref: SCREX4020-\*



Para Cristal 6+6  
Ref: SCUEX12

### REGULABLES



**MOD. ELBA**  
**40x40**  
Ref: SCREX4040-





## SOPORTES PASAMANOS DE ALUMINIO



**NORMAL**  
Ref: SOP-\*

EN STOCK: LACADOS BLANCO Y NEGRO Y ANODIZADOS PULIDOS PLATA, INOX Y ORO



POSIBILIDAD DE ACABADOS ANODIZADOS

**ALTO**  
Ref: SOPAL-\*

## APOYO INTERMEDIO DE ALUMINIO



Altura: 90 mm.  
**APOYO INTERMEDIO**  
Ref: AIB-\*



POSIBILIDAD DE ACABADOS ANODIZADOS



## SOPORTES DE ALUMINIO

Para volar barandillas en escaleras y terrazas



**30x30**  
Ref: 9530 \*

POSIBILIDAD DE ACABADOS ANODIZADOS



**40x20**  
Ref: 9540 \*

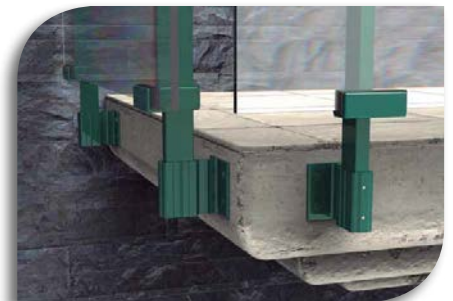

## FIJACRISTALES DE ALUMINIO PARA BARANDILLA



**MOD. SENA**  
Ref: FCSEN-\*



**RECTO**  
Ref: FCRE-\*



**CONVERSOR FIJACRISTAL DE SENA A RHIN**  
Ref: FCCON-



**INCLINADO DERECHO**  
Ref: FCID-\*

Para fijar a tubo redondo



**MOD. RHIN**  
Ref: FCRHI-\*



**INCLINADO IZQUIERDO**  
Ref: FCII-\*

## FIJABARANDILLAS DE ALUMINIO A PARED



**FIJADOR BARANDILLA DESPLAZADA**  
Ref: FIBADE-\*



**FIJABARANDILLAS**  
Ref: FBPA-\*



**FIJABARANDILLAS CORTADO**  
Ref: FBCO-\*



**FIJA TUBO REDONDO**  
Ref: FBRE-\*

\* Piezas Certificadas por CIDEMCO-TECNALIA



## COMPENSADORES DE ALUMINIO PARA TUBO

Para fijar Antepechos, Quitamiedos, Barandas, etc.



**MOD. ANETO**  
**Ø40**  
Ref: CTUR40-\*



**MOD. TEIDE**  
**Ø50**  
Ref: CTUR50-\*



**MOD. GREDOS**  
**Ø60**  
Ref: CTUR60-\*



## COMPENSADORES DE ALUMINIO PARA PERFILES DE BARANDILLA

Para fijar barandillas a pared o pilastra

POSIBILIDAD DE ACABADOS ANODIZADOS

### SUPERIORES



**Ø60U40**  
Ref: CSU3EX60-\*



**Ø66U51**  
Ref: CSUR66-\*



**Ø60U40**  
Ref: CSUR60-\*



**60x40**  
Ref: CSU6040-\*



**66x40**  
Ref: CSU6640-\*



**70x40**  
Ref: CSU7040-\*



### INFERIORES



**51x21**  
Ref: CIN5121-\*



**43x24**  
Ref: CIN4324-\*



**47x18**  
Ref: CIN4718-\*



**40x20**  
Ref: CIN4020-\*





## TAPAS DE ALUMINIO



**APOLO Ø40**  
Ref: TAPAPOLO-



**Ø40**  
Ref: TAPAL40-



**Ø50**  
Ref: TAPAL50-



**Ø60**  
Ref: TAPAL60-



**40x20**  
Ref: TAPAL4020-



**40x40**  
Ref: TAPAL4040-



**40x60**  
Ref: TAPAL4060-



**40x80**  
Ref: TAPAL4080-



**40x100**  
Ref: TAPAL40100-



**40x120**  
Ref: TAPAL40120-



## REMATES BOLA DE ALUMINIO



**40x40**  
Ref: RB4040-



**60x60**  
Ref: RB6060-

**70x70**  
Ref: RB7070-

**80x80**  
Ref: RB8080-



**100x100**  
Ref: RB100100-



## REMATES PIRÁMIDE DE ALUMINIO



**60x60**  
Ref: PIR6060-\*

**70x70**  
Ref: PIR7070-\*

**80x80**  
Ref: PIR8080-

**100x100**  
Ref: PIR100100-



### PIRÁMIDE PLANA

**60x60**  
Ref: PIP6060-\*

**70x70**  
Ref: PIP7070-\*





## REMATES DE ALUMINIO PARA PERFIL EN "U"



**PARA "U" DE 40x20**

Ref: RP4020-

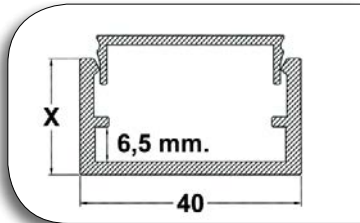

**PARA "U" DE 51x21**

Ref: RP5121-

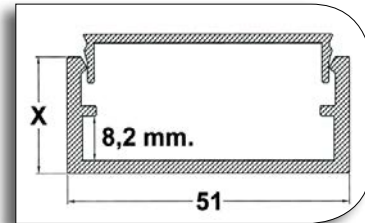

Sirven para tapar los Perfiles en "U" de 40x20 y de 51x21 más la Grapa o Tapeta, que se utilizan para barandillas y otros trabajos.

## REMATES DE ALUMINIO PARA PASAMANOS



Para U de 40

Ref: RP08-



Para U de 40

Ref: RP09-



Para U de 40

Ø60

Ref: RP60U40-



Para U de 51

Ø66

Ref: RP66U51-



Para U de 40

60x40

Ref: RP6040U40-



Para U de 51

60x40

Ref: RP6040U51-



Para U de 43

66x40

Ref: RP20P-  
(Plástico)



70x40

Ref: RP11-



Para U de 47

70x40

Ref: RP12-



**IZQUIERDO**

Ref: RPAB03I-



**DERECHO**

Ref: RPAB03D-

### PARA BARROTE

**IZQUIERDO**

Ref: RBAB03I-



**DERECHO**

Ref: RBAB03D-

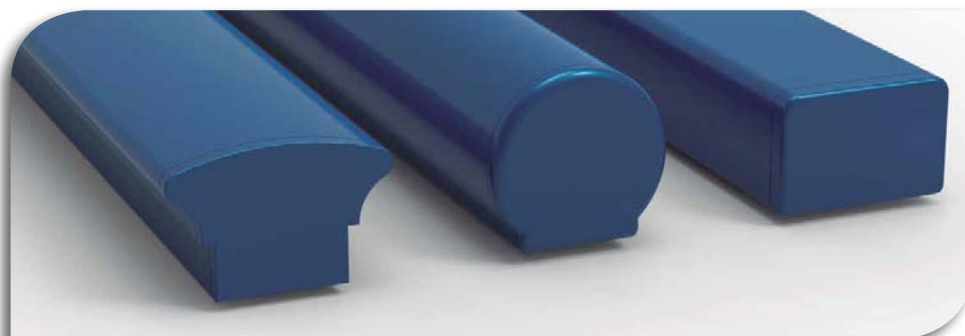

## KIT BISAGRA-ESCUADRA MULTIFUNCIÓN PARA BARANDILLA

**ALUMINIO**

### MULTI-B

Uno o varios Kits permiten múltiples formas de montaje:

- Unir tramos de distintos niveles
- Unir perfiles con cualquier ángulo de giro, y posibilidad de unir tramos rectos
- Unir tramos de distinto nivel y a la vez giros de cualquier ángulo

Incluye Espárragos, Pasador y Eje

Ref: MULTI-B36 (para U de 40 mm.)\*

Ref: MULTI-B45 (para U de 51 mm.)\*

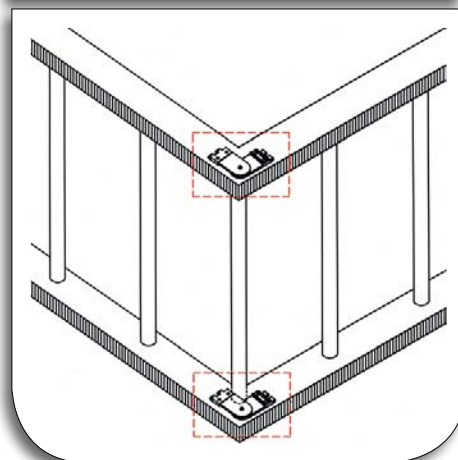
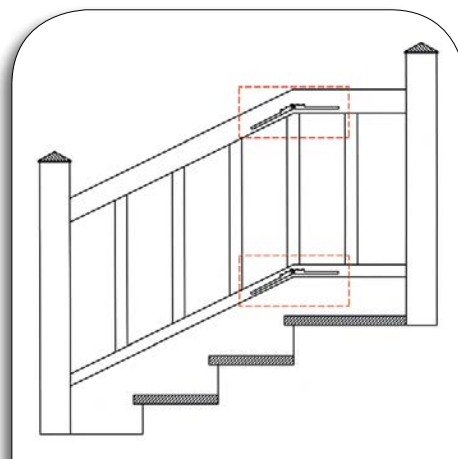

## ESCUADRAS PARA "U" DE 40 mm.



**ESCUADRA FIJA DE ALUMINIO**

Ref: 9710



**ESCUADRA FIJA DE ZAMAC**

Ref: 9715



**ESCUADRA REGULABLE DE ZAMAC**

Ref: 9705

## ESCUADRA Y UNIÓN PARA "U" DE 51 mm.



**ESCUADRA FIJA DE ALUMINIO U-51**

Ref: EFAU51



**UNIÓN DE ALUMINIO U-51**

Ref: UNAU51

## ESCUADRAS DE ÁNGULO VARIABLE

Fijación oculta a Pilastra o a Pared de la "U" de Barandilla+Tapeta o de la "U" de Barandilla+Pasamanos



**ALUMINIO**



Ref: EVA40-  
Para perfiles "U" de 40 x cualquier altura

Ref: EVA51-  
Para perfiles "U" de 51 x cualquier altura

Fijación mediante Espárragos de Acero Inox. con Punta M-6x8 incluidos.  
Una vez fijada la Escuadra, en el exterior de la barandilla no se ven ni tornillos ni remaches.

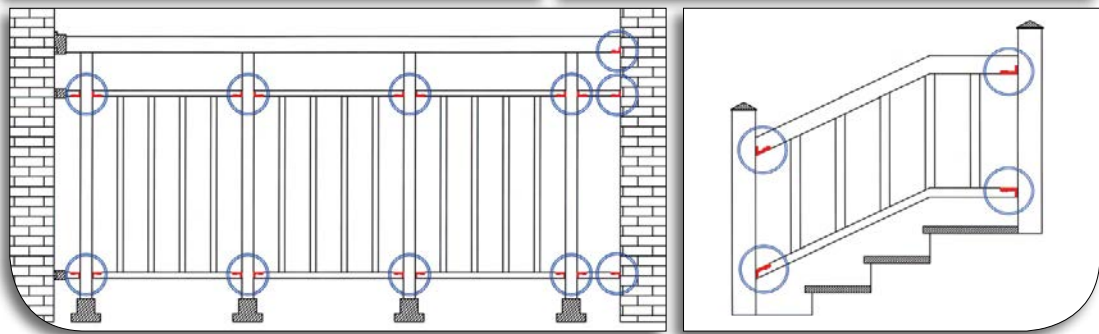
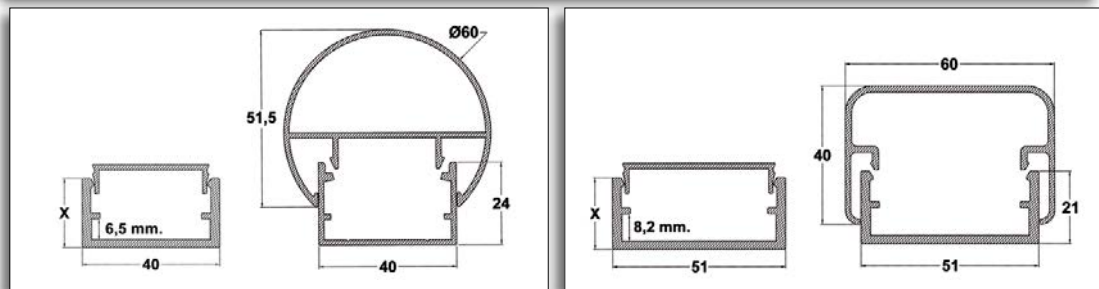
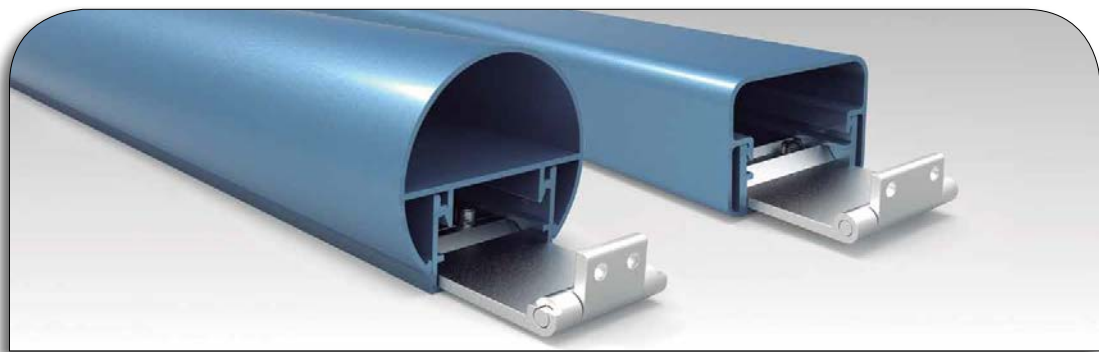

## UNIÓN PARA PASAMANOS Ø60 "U" DE 40 mm.

Permite la unión de tramos largos de pasamanos



POSIBILIDAD DE ACABADOS ANODIZADOS



Longitud: 120 mm.

**UNIÓN PASAMANOS DE ALUMINIO Ø60U40**

Ref: UNEX60-



## REMATES PÉRGOLA DE ALUMINIO



**60x40**

Ref: PER6040-

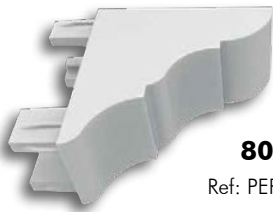

**80x40**

Ref: PER8040G-

PARA PERFILES CON O SIN GUÍA



**100x40**

Ref: PER1040-



**120x40**

Ref: PER1240-



**150x65**

Ref: PER1565-





## ACCESORIOS DE ALUMINIO PARA EL MONTAJE DE PÉRGOLAS



**SUPERIOR**

Ref: PALSU60-



**SUPERIOR**

Ref: PALSU-

**DOBLES PECHO PALOMA**  
60x60 - Ø40 - Ø60

**DOBLES PECHO PALOMA**  
80x40



**INFERIOR**

Ref: PALIN60-



**INFERIOR**

Ref: PALIN-



**BASE DE SUELO**

Para tubos de ancho 40 mm.

Ref: BASSU-

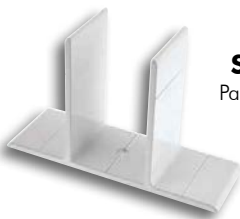

**SOPORTES PARED**  
Para tubos de ancho 40 mm.

**LONGITUD 40 mm.**  
Ref: SOPPA4-



**LONGITUD 80 mm.**  
Ref: SOPPA8-



Bajo pedido podemos fabricar Soportes Pared en otras longitudes.

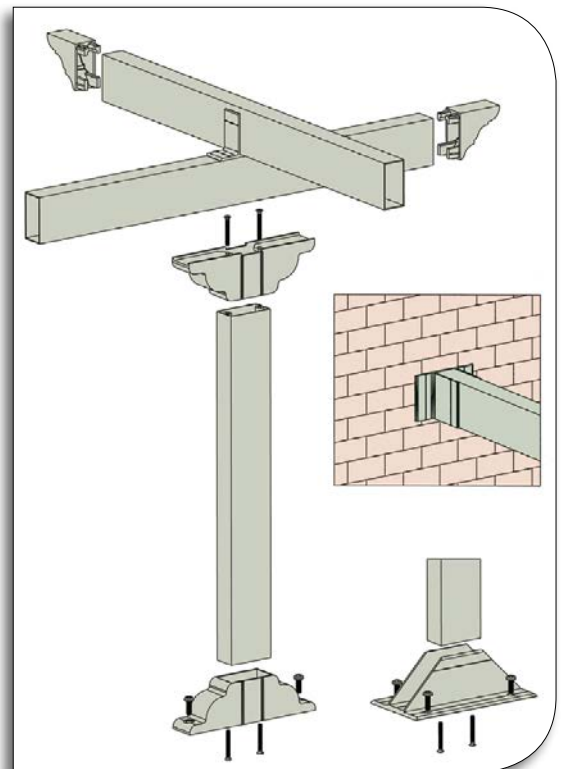

## PIEZAS DE ALUMINIO PARA REALIZAR COLUMNAS

Especialmente diseñado para la construcción de Pérgolas, Porches, Toldos, Verandas ...

La misma pieza sirve para Tubos 100x100, Ø80 y/ó Ø100 mm.



**MULTIBASE CAPITEL  
MOD. ÁNFORA**  
Ref: MBACANF-



**MULTI INTERCAMBIADOR**  
Ref: MINT8010-



**MULTIBASE CAPITEL  
MOD. GRECIA**  
Ref: MBACGRE-



La misma pieza sirve para Tubos 80x80, 100x100, Ø80 y/ó Ø100 mm.



**DOBLE PECHO PALOMA  
SUPERIOR e INFERIOR**  
Ref: DPP8010-





## TUBO Y ACCESORIOS DE ALUMINIO PARA REALIZAR PÉRGOLAS



**TUBO PÉRGOLA DECORATIVO 120x120 mm.**

Grosor: 1,8 mm.

Ref: TUPE120X5-

Ref: TUPE120X6-



**DOBLE PECHO PALOMA SUPERIOR**

Ref: DPSU120-



**DOBLE PECHO PALOMA INFERIOR**

Ref: DPIN120-



**REMATE PÉRGOLA**

Ref: REPE120-



**UNIÓN**

Ref: UNTU120-



**CRUCETA**

Ref: CRTU120-



**TAPA**

Ref: TATU120-



**FIJA-TUBO  
SUELO O PARED**

Ref: FITU120



**STICK PLR-SYSTEM  
(incolore) 12 ml.**

Ref: 190



**STICK  
RAL 3005  
12 ml.**

Contiene una laca incolora que, mezclada con laca en polvo, permite realizar un stick en el RAL deseado



**SPRAY  
150/400 ml.**

Fabricamos Sticks o Sprays en cualquier color.

COLORES EN STOCK		STICK 12 ml.	SPRAYS 150 ml.	SPRAYS 400 ml.
Plata		Ref: 100	Ref: 200	Ref: 2004
Oro		Ref: 105	Ref: 205	
Bronce medio		Ref: 110	Ref: 210	Ref: 2104
Bronce oscuro		Ref: 115	Ref: 215	
Negro mate		Ref: 120	Ref: 220	Ref: 2204
Negro brillo		Ref: 121	Ref: 221	Ref: 2214
Blanco		Ref: 125	Ref: 225	Ref: 2254
Marfil	RAL-1015	Ref: 130	Ref: 230	
Amarillo	RAL-1021		Ref: 235	
Naranja	RAL-2004	Ref: 140	Ref: 240	
Rojo	RAL-3000		Ref: 245	
Burdeos	RAL-3004		Ref: 249	
Burdeos	RAL-3005	Ref: 150	Ref: 250	
Burdeos	RAL-3007	Ref: 153	Ref: 253	
Azul	RAL-5010	Ref: 155	Ref: 255	
Verde	RAL-6002	Ref: 160	Ref: 260	
Verde	RAL-6005	Ref: 162	Ref: 262	
Verde	RAL-6009	Ref: 163	Ref: 263	
Gris	RAL-7011	Ref: 164	Ref: 264	
Gris	RAL-7016	Ref: 166	Ref: 266	
Gris	RAL-7022	Ref: 167	Ref: 267	
Gris	RAL-7035	Ref: 165	Ref: 265	
Inox	RAL-7048	Ref: 180	Ref: 280	
Marrón	RAL-8007	Ref: 169	Ref: 269	
Marrón	RAL-8014	Ref: 170	Ref: 270	
Marrón	RAL-8017	Ref: 173	Ref: 273	



**PISTOLA PARA PINTAR CON SPRAY**

(Para Sprays de cualquier tamaño)

Ref: PPP



**SPRAY GALVANIZADO 400 ML.  
ALUMINIO PURO 99,5%**

Ref: 315

Para galvanizado en frío.  
Protege contra la corrosión y la intemperie.  
Resiste hasta 600°C.



**CARTA DE COLORES RAL**

Ref: RAL



## ALUCLEAN - LIMPIEZA DE LACADOS Y ANODIZADOS

Líquido que limpia en profundidad las superficies de aluminio lacado, especialmente el color blanco, eliminando suciedad, restos de adhesivo, etc., haciendo desaparecer los pequeños arañazos y roces.

Asimismo elimina marcas de rotulador u otros en superficies de aluminio anodizado.



**ENVASE METÁLICO 5 litros**  
Ref: ALUC-05L



**ENVASE METÁLICO 500 ml.**  
Ref: 715

## BORRADOR - LIMPIEZA DE ANODIZADOS

Elimina marcas de lapicero, rotulador, suciedad, pequeños roces y arañazos en superficies de aluminio anodizado, sin rayarlas.



Ref: 600

## PRODUCTO DE LIMPIEZA PARA PVC

### PV-CLEAN 212



**ENVASE METÁLICO 500 ml.**  
Ref: PV-CL212

Líquido que limpia en profundidad las superficies de PVC, incluso las foliadas.

Elimina suciedad, marcas de lápiz, rotulador, restos de adhesivos o sellantes, etc.



## SEALANT

PARA ALUMINIO, PVC Y ACERO INOXIDABLE

Sellador en base acuosa, de alta resistencia a la intemperie y a los rayos U.V.  
Evita la posible entrada de agua y aire, protegiendo de la oxidación los cortes de los perfiles.  
Colores: Transparente y Blanco

**310 ml.**

Ref: SEA-CAR (Transp.)  
Ref: SEA-CARB (Blanco)

**500 gr.**

Ref: SEA-BO500 (Transp.)  
Ref: SEA-BO500B (Blanco)

**1 Kg.**

Ref: SEA-01 (Transp.)  
Ref: SEA-01B (Blanco)

**4 Kg.**

Ref: SEA-04 (Transp.)  
Ref: SEA-04B (Blanco)

## SELLADOR A BASE DE MORTERO ELÁSTICO

## SELLA-ELASTIC

PARA EL RELLENO Y SELLADO DE JUNTAS, GRIETAS, FISURAS, ETC.

**310 ml.**

Ref: SECA-A

Una materiales de diversas naturalezas sin alterar su equilibrio estético. Puede pintarse con pinturas al agua.  
Soporta las dilataciones y contracciones de la construcción, y presenta una gran resistencia a los agentes atmosféricos.

**Indicado para:**

- Armado y sellado de marcos de ventanas y puertas de aluminio lacado o anodizado, PVC, madera, etc.
- Montaje y sellado de balcones y galerías.
- Relleno y sellado de fisuras, remates, grietas y juntas de dilatación.
- Unión de la mayoría de los materiales empleados en la construcción (piedra, hormigón, yeso, teja, pizarra, mármol, poliuretano, etc.) sin alterar sus coeficientes de dilatación o conductividad térmica.

Color: Beige-Arena

Bajo pedido podemos fabricar en otros tonos.

## ALU-GLUE - ADHESIVO DE CONTACTO



INSTANTÁNEO

**ENVASE 20 gr.**

Ref: ALU-GLUE

CIANOACRILATO

Indicado para aluminio, hierro, plástico (PVC, ABS, metacrilato, policarbonato, poliéster, nylon), goma, madera, cerámica, etc.

# TUBOS TORNEADOS DE ALUMINIO Ø32MM.

www.joaquinplata.es

www.laferreteriaindustrial.es

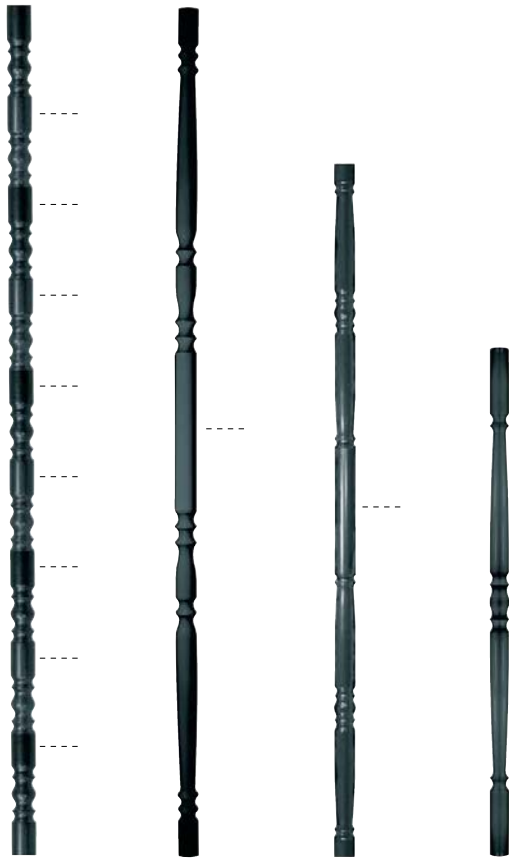

5.850 mm. "NIZA" Ref: TNI5850-\*  
 1.500 mm. "ATENAS" Ref: TAT1500-\*  
 1.280 mm. "BALEARES" Ref: TBA1280-\*  
 880 mm. "CANARIAS" Ref: TCA0880-

Ref: TNI5850-\* Ref: TAT1500-\* Ref: TBA1280-\* Ref: TCA0880-

El modelo NIZA se puede cortar cada 160 mm.  
 El modelo ATENAS se puede cortar cada 750 mm.  
 El modelo BALEARES se puede cortar cada 640 mm.



También disponible  
 sin casquillo  
 Ref: LAAL-



**CASQUILLO DE FIJACIÓN PARA TUBOS Ø32 mm.**  
 Ref: CFNY \*  
 (Plástico Negro)

Montaje con 1 tornillo



**SOPORTE FINAL Ø32**  
 Ref: SFIA-



**FIJACIÓN INTERMEDIA Ø32**  
 Ref: FINA-

**LANZA**  
 20x20 Ref: LAAL2020-  
 Ø30 Ref: LAAL30-  
 Ø32 Ref: LAAL32-



**SOPORTE DOBLE Ø32**  
 Ref: SDO32-





## MACOLLAS

**150 mm.**  
Ref: ALU-150



**75 mm.**  
Ref: ALU-075



**40 mm.**  
Ref: ALU-040



## TUBO REFORZADO Ø22 mm.

Longitud máxima 5.100 mm.

Ref: T-5100 \*

Acabados: Lacado Blanco, Negro, Colores y Anod. Inox.



**BASE**  
Ref: ALU-BA



**RÓTULA**  
Ref: ALU-RA



**SOPORTE**  
Ref: ALU-ST



**SOPORTE CON ROSETA**  
Ref: ALU-STR



**REMATE CÓNICO**  
Ref: RECO22-



**SOPORTE INTERMEDIO**  
Ref: SDA-



ANODIZADO ORO, ANODIZADO INOX., LACADO COLORES





**LLAMADOR CABEZA DE LEÓN**  
Ref: ALU-LLAL



**LLAMADOR MANO**  
Ref: ALU-LLAM



**LLAMADOR COPA**  
Ref: ALU-LLAC



**LLAMADOR GALA**  
Ref: ALU-GAL

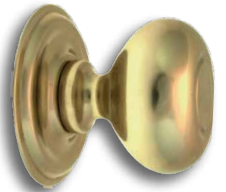

**POMO**  
Ref: ALU-PO

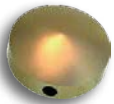

(Métrica 8)

**TUERCA DECORATIVA**  
Ref: TUAL8-



**EMBELLECEDOR DE BOMBÍN**  
Ref: EMBALOVA-



**MIRILLAS**

PARA GROSORES DE PUERTA de 11 a 21 mm.

**CORTA**  
Ref: ALU-MI

de 21 a 36 mm.  
**MEDIANA**  
Ref: ALU-MIM

de 27 a 55 mm.  
**LARGA**  
Ref: ALU-MIL

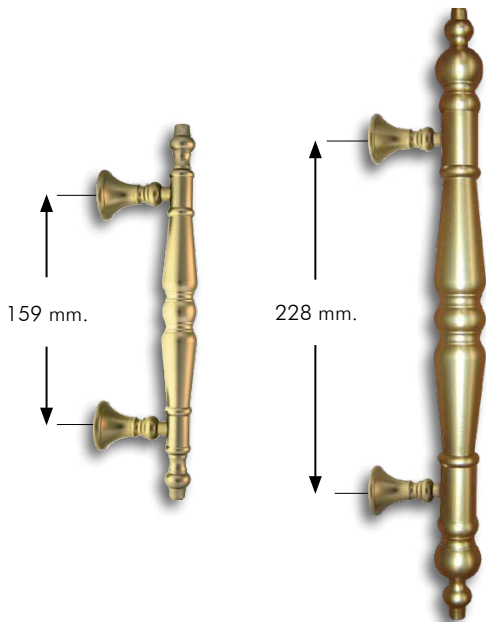

159 mm.

228 mm.

**TIRADOR RECTO 250/400 mm.**  
(250 MM.) (400 MM.)  
Ref: ALUTR25- Ref: ALUTR40-

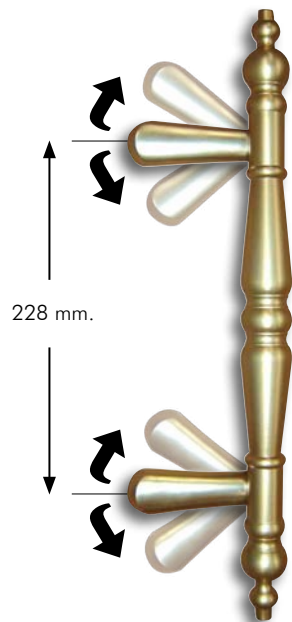

228 mm.

**TIRADOR DESPLAZADO 400 mm.**  
Ref: ALUTCR40- (simple) (REGULABLE)  
Ref: ALUTC40J- (juego)



**ROSETA 225x90 mm.**  
Ref: ALURO2-



**ROSETA Ø82 mm.**  
Ref: ALURO3-



**ROSETA Ø50 mm.**  
Ref: ALURO1-

ANODIZADO ORO, ANODIZADO INOX., LACADO COLORES



## TIRADORES

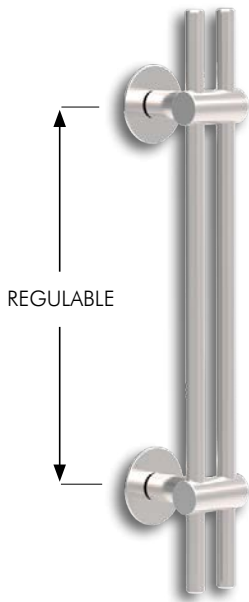

REGULABLE

### STUTTGART

**Largo 300 mm.  
2 x Ø10 mm.**

Ref: TIRSTU- (simple)  
Ref: JTIRSTU- (juego)

Estos Tiradores en Acero Inoxidable disponen de un innovador y sencillo sistema de centros regulables, que permite su adaptación a cualquier medida entre ejes.

Ver video en nuestro canal de: [YouTube](#)

Los Tiradores simples se suministran siempre con 2 tuercas mod. Frankfurt

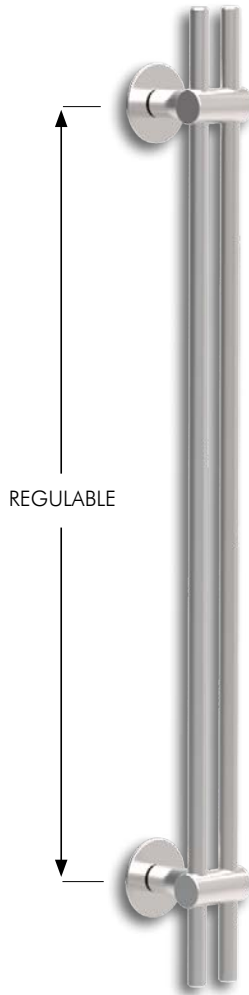

REGULABLE

### MUNICH

**Largo 500 mm.  
2 x Ø10 mm.**

Ref: TIRMUN- (simple)  
Ref: JTIRMUN- (juego)

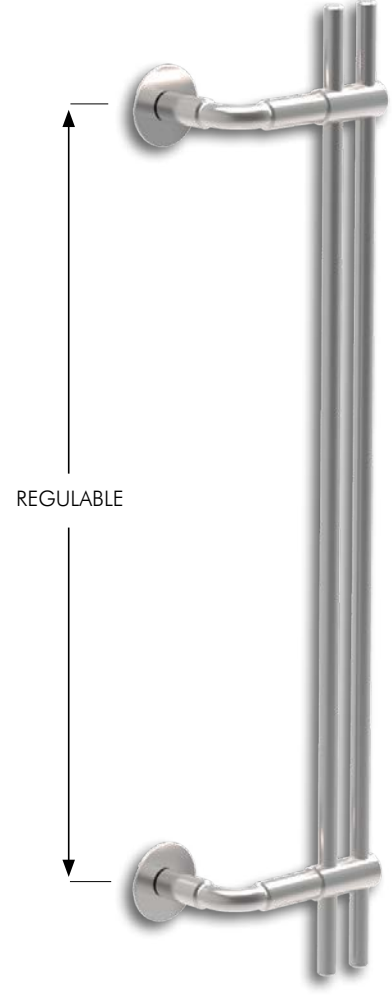

REGULABLE

### LEIPZIG

**Largo 500 mm.  
2 x Ø10 mm.**

Ref: TIRLEI- (simple)  
Ref: JTIRLEI- (juego)  
(DESPLAZADO)

Bajo pedido se pueden fabricar Tiradores a la longitud total deseada.

## POMO



### HAMBURGO

Ref: POMOHA

El Pomo "Hamburgo" se suministra siempre con 1 tuerca mod. Frankfurt



## MIRILLA



### COLONIA

Ref: MIRCOL

PARA GROSORES DE PUERTA  
de 22 a 39 mm.





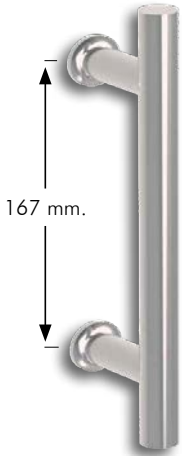

**MERCURIO**

**Largo 250 mm. \***  
**Ø19 mm.**

Ref: TMER25- (simple)  
Ref: JTMER25- (juego)

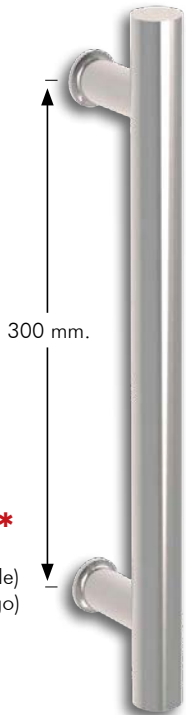

**LÁSER**

**Largo 400 mm. \***  
**Ø30 mm.**

Ref: TLAS40- (simple)  
Ref: JTLAS40- (juego)

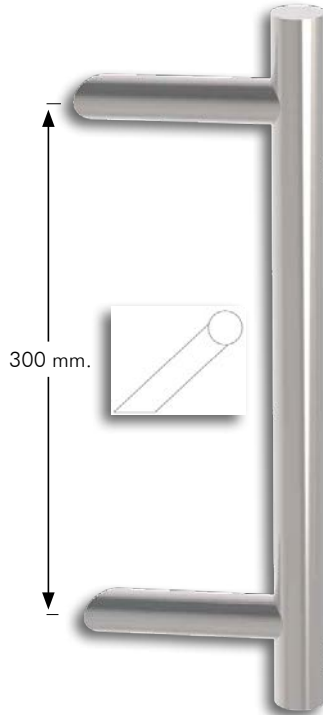

**NEPTUNO**

**Largo 400 mm. \***  
**Ø30 mm.**

Ref: TNEP40- (simple)  
Ref: JTNEP40- (juego)  
(DESPLAZADO)

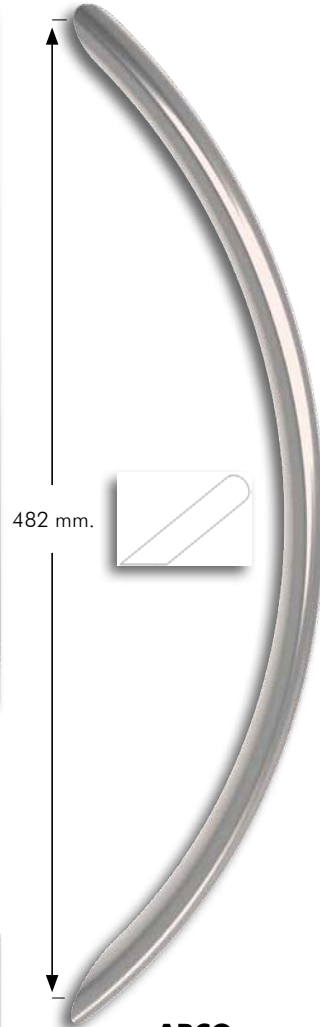

**ARCO**

**Largo 600 mm.**  
**Ø30 mm.**

Ref: TARCO60- (simple)  
Ref: JTARCO60- (juego)  
(DESPLAZADO)

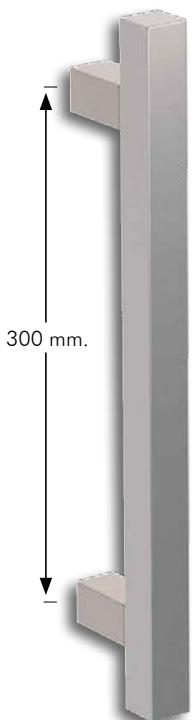

**DIANA**

**Largo 400 mm. \***  
**25x25 mm.**

Ref: TDIA40- (simple)  
Ref: JTDIA40- (juego)

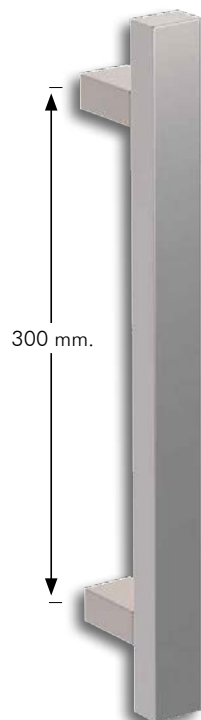

**MINERVA**

**Largo 400 mm. \***  
**30x20 mm.**

Ref: TMIN40- (simple)  
Ref: JTMIN40- (juego)

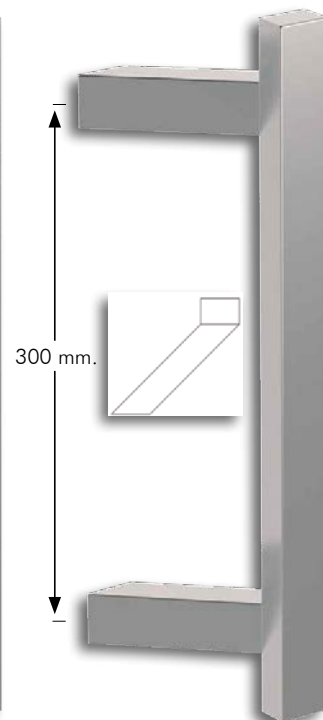

**JÚPITER**

**Largo 400 mm. \***  
**30x20 mm.**

Ref: TJUP40- (simple)  
Ref: JTJUP40- (juego)  
(DESPLAZADO)

Los Tiradores simples se suministran siempre con 2 tuercas mod. Apolo



\* Bajo pedido se pueden fabricar a la medida deseada, tanto de la longitud total, como de la medida entre ejes.

ANODIZADO INOX., ANODIZADO ORO, LACADO COLORES

## MODELO APOLO PARA TUBO Ø40

Sirve para fabricar tanto Tiradores exteriores, como Juegos de Tirador (exterior + interior)

Se suministra siempre con un suplemento de plástico para la colocación en cristal



**SOPORTE TIRADOR APOLO**  
Ref: SOTIAPOLO-



**TUBO Ø40 x 2100 MM.**  
Ref: TR402100-



**TAPA ALUMINIO APOLO**  
Ref: TAPAPOLO-



**TUERCA CIEGA APOLO**  
Ref: TUAPOLO-



ANODIZADO INOX Y PLATA,  
LACADO BLANCO, NEGRO Y COLORES

# MULTIADAPTADOR DE ALUMINIO

## MODELO JANO PARA TUBO Ø40 Y Ø50



**MULTIADAPTADOR 40/50 JANO**  
Ref: ADAJANO-

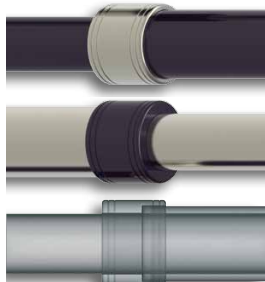

El tubo Ø40 mm., al poder ser pasante, refuerza la aplicación

Permite la combinación de dos tubos de diferentes diámetros, siendo uno de ellos de Ø40 mm. (con posibilidad de ser pasante) y el otro de Ø50 mm.

Especialmente diseñado para realizar tiradores originales, quitamiedos, etc.



ANODIZADO INOX., LACADO BLANCO, NEGRO Y COLORES



## JUEGO MULTI-SOPORTE TIRADOR PARA TUBO Ø40 - Ø50

Sirve para fabricar tanto Tiradores exteriores, como Juegos de Tirador (exterior + interior) con tubo redondo standard de 40 ó 50 mm. en cualquier longitud, evitando tener 2 stocks.

Opcionalmente se puede reforzar el tirador con una varilla roscada por el interior.

EL KIT INCLUYE:

- 2 Soportes de aluminio lacado
- 2 Espárragos
- 4 Tuercas ciegas



Ref: JST14050-

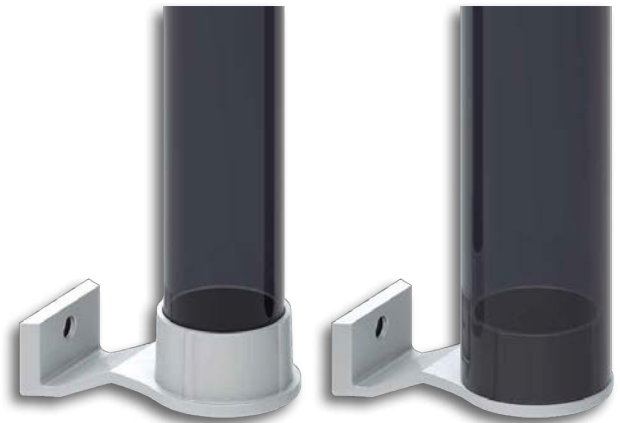

Ø40 mm.

Ø50 mm.



LACADO BLANCO, NEGRO, PLATA Y COLORES





## MODELO A

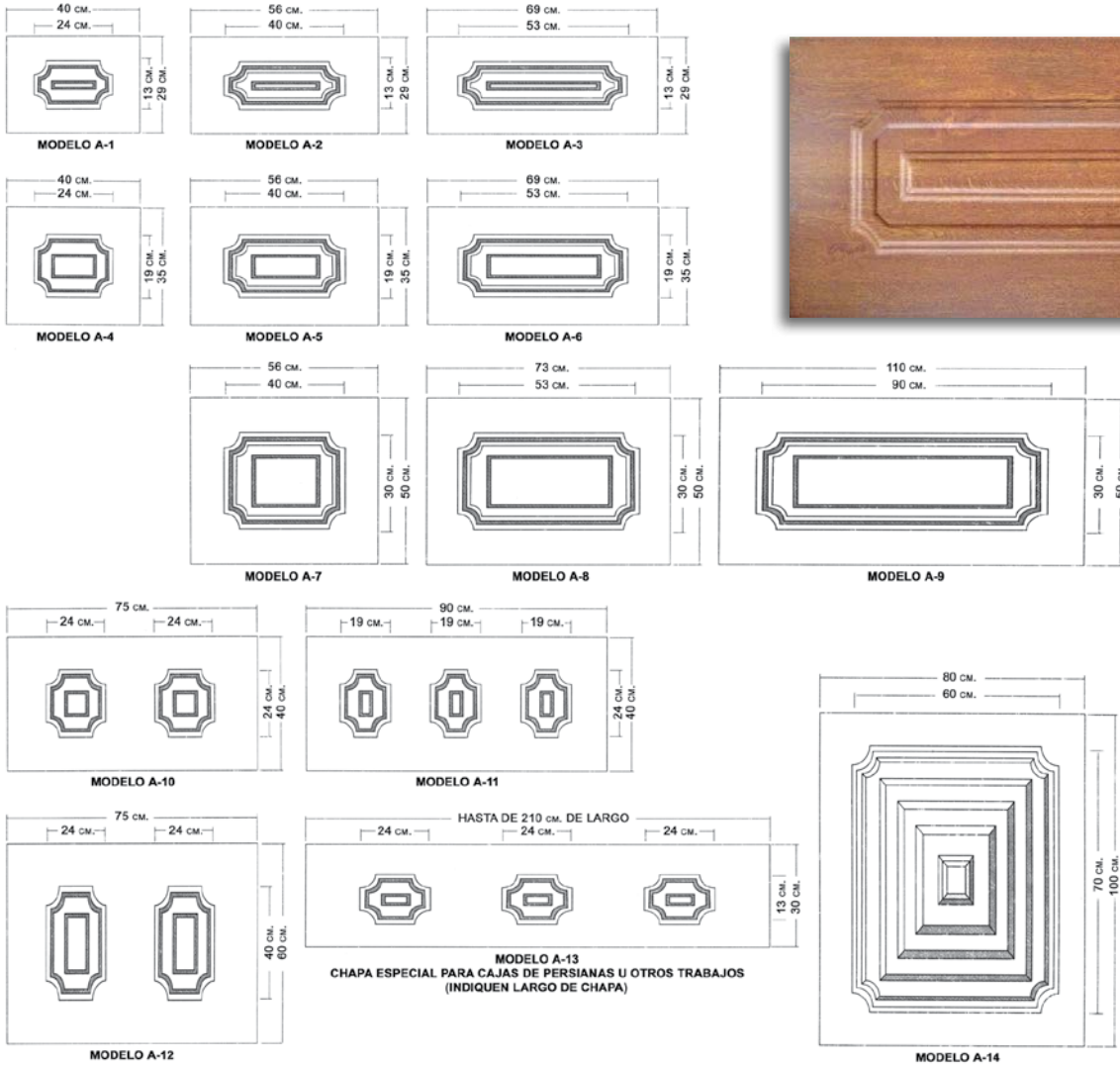

## MODELO K

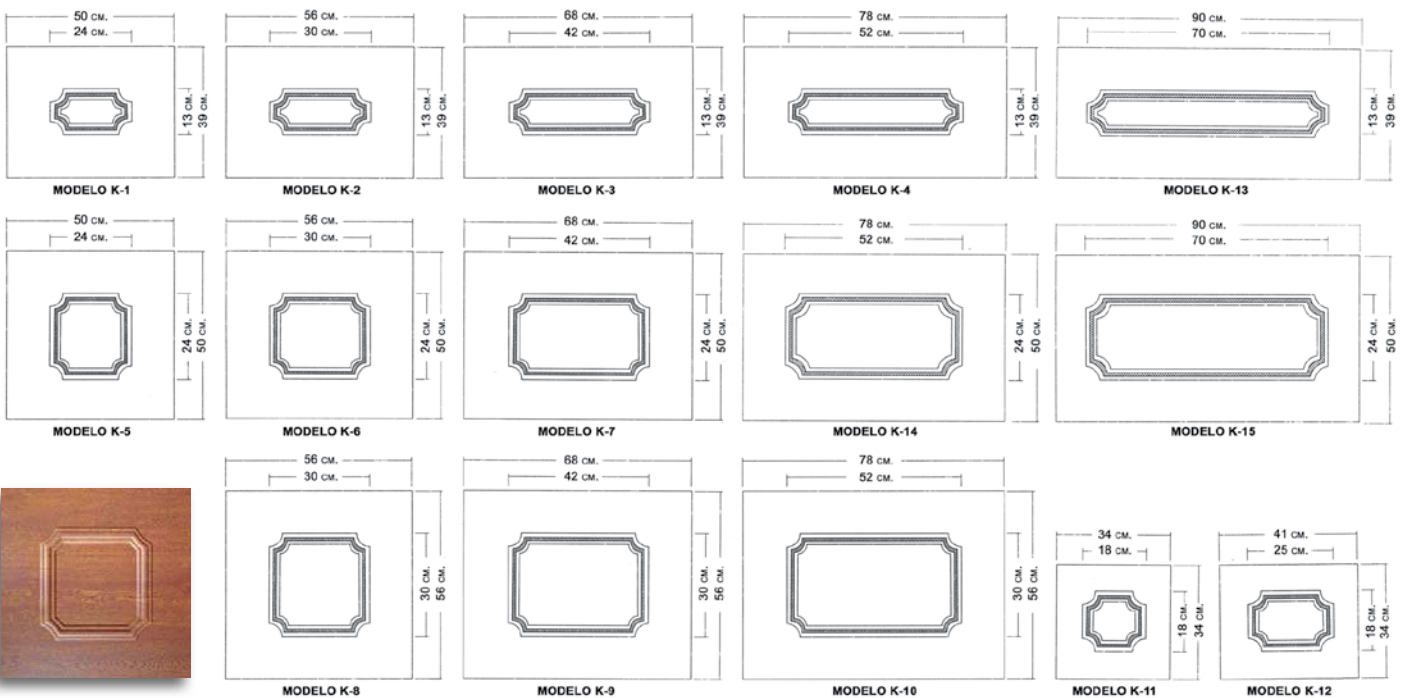

ACABADOS: LACADO, ANODIZADO O BRUTO

Fabricación de chapas de medidas especiales, lacado imitación madera o foliado y sándwich

## MODELO G

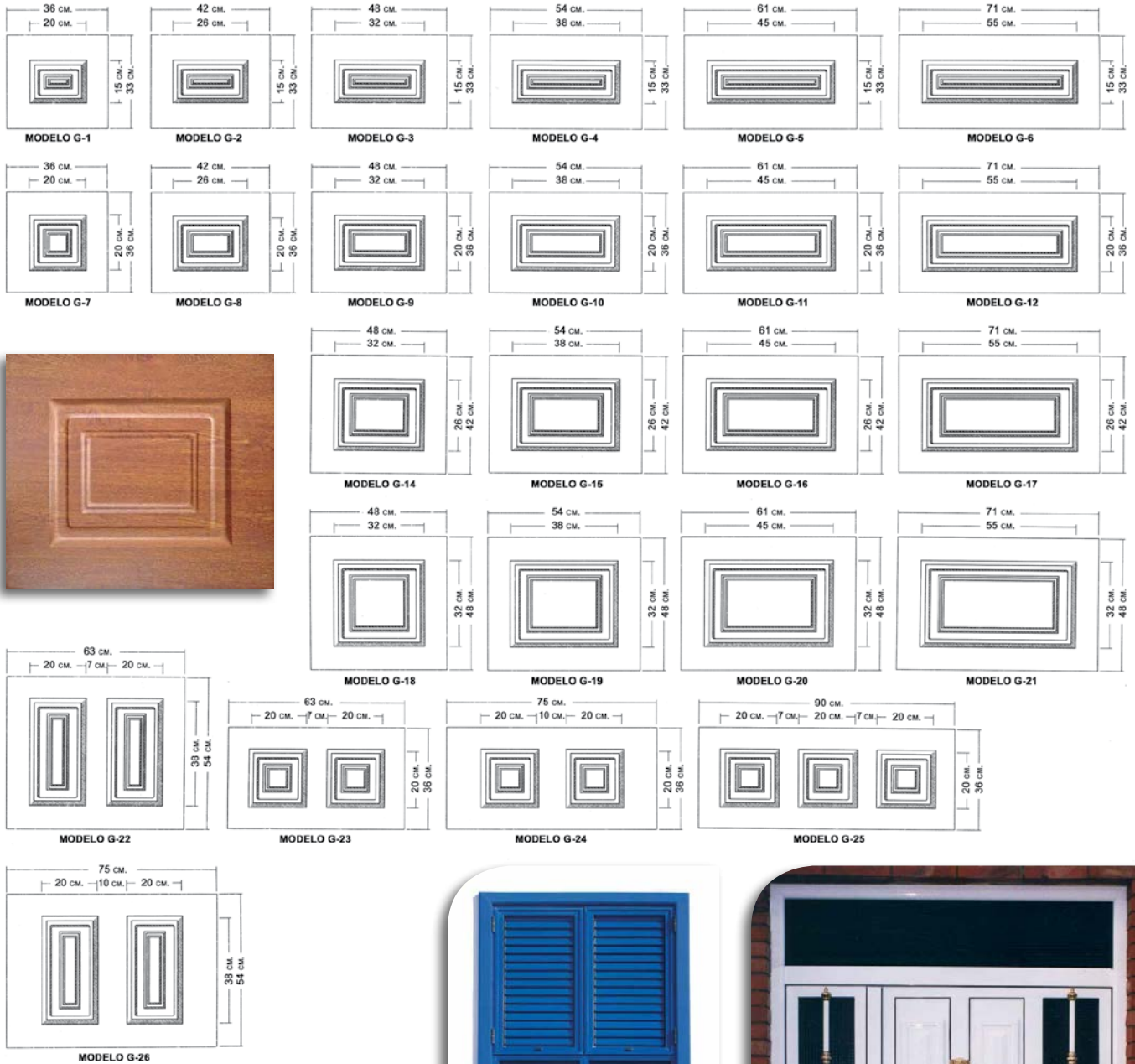

ACABADOS: LACADO, ANODIZADO O BRUTO

Fabricación de chapas de medidas especiales, lacado imitación madera o foliado y sándwich



## MODELO M

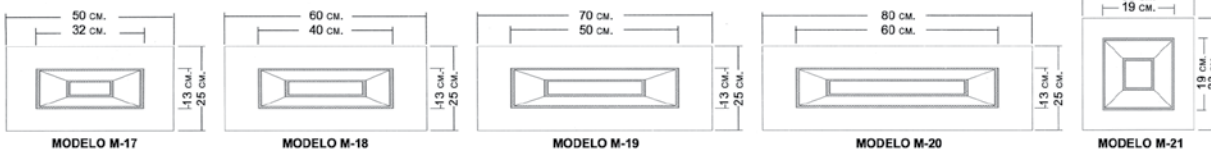
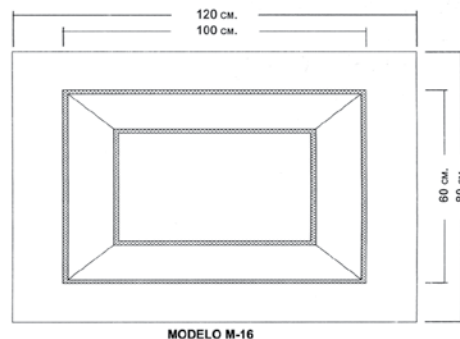
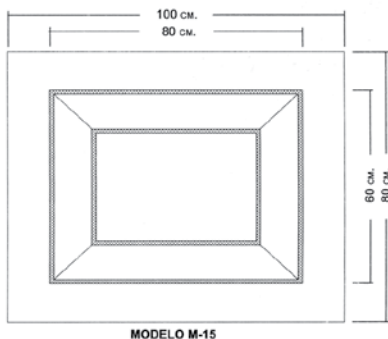
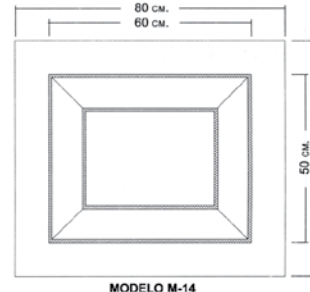
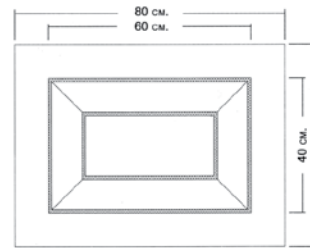
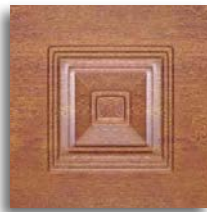
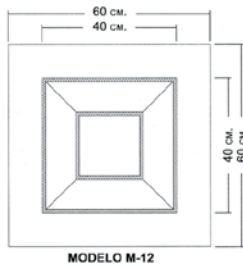
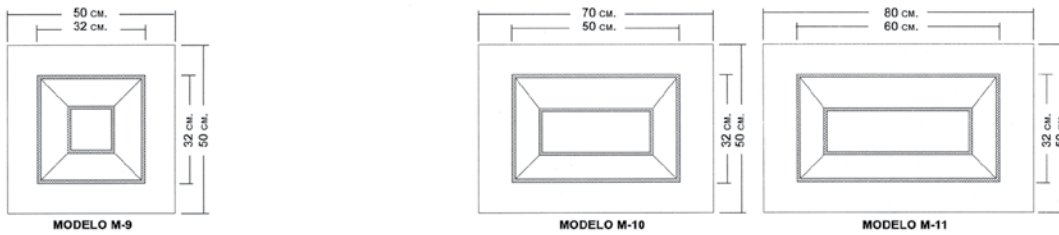
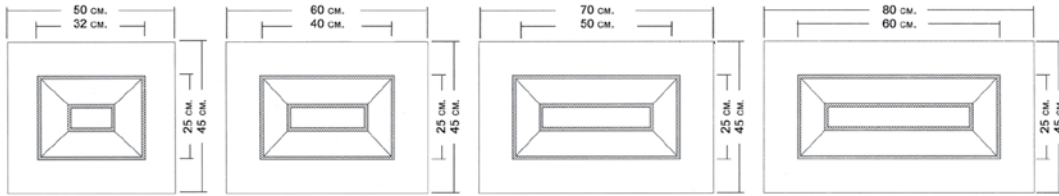
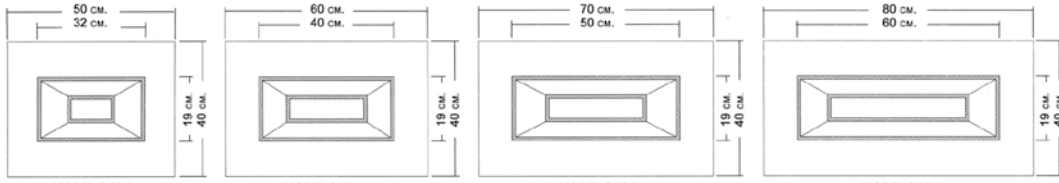

ACABADOS: LACADO, ANODIZADO O BRUTO

Fabricación de chapas de medidas especiales, lacado imitación madera o foliado y sándwich





## MODELO E

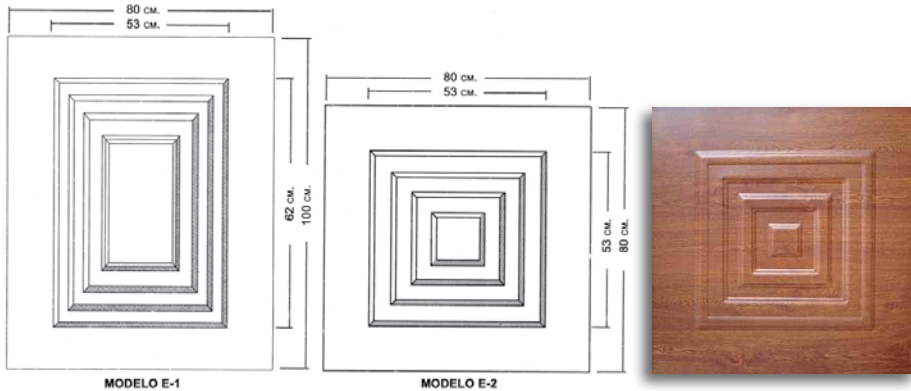

## ARCOS



## MODELO CB

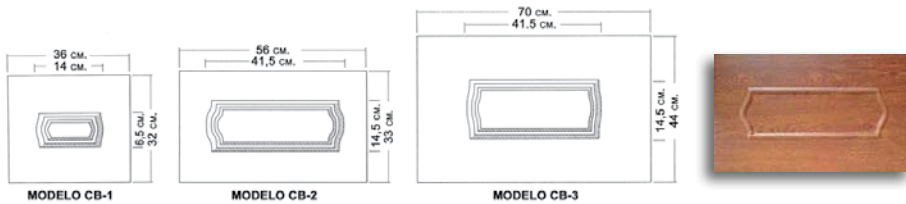

## MODELO CJ

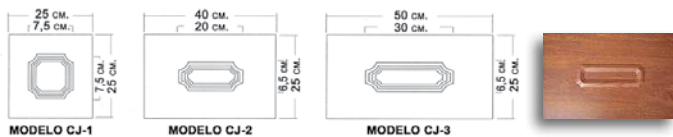

ACABADOS: LACADO, ANODIZADO O BRUTO

Fabricación de chapas de medidas especiales, lacado imitación madera o foliado y sándwich

# REJILLAS DE VENTILACIÓN DE ALUMINIO



**REJILLA DE 200x200 mm.**  
Ref: RVC-2



**REJILLA DE 800x200 mm.**  
Lacada por 1 cara  
Ref: RVC-8



**REJILLA SÁNDWICH DE 800x200x18/20 mm.**  
Ref: RVSAN-

**REJILLA DE 800x200 mm.**  
Lacada por 2 caras  
Ref: RVC-8X

Núcleo de Poliestireno Extruido

## CHAPA FRESADA DECORATIVA DE ALUMINIO

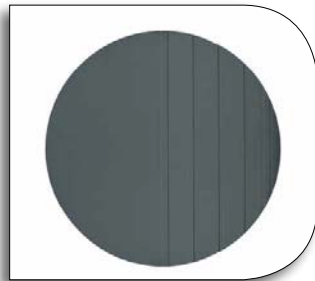
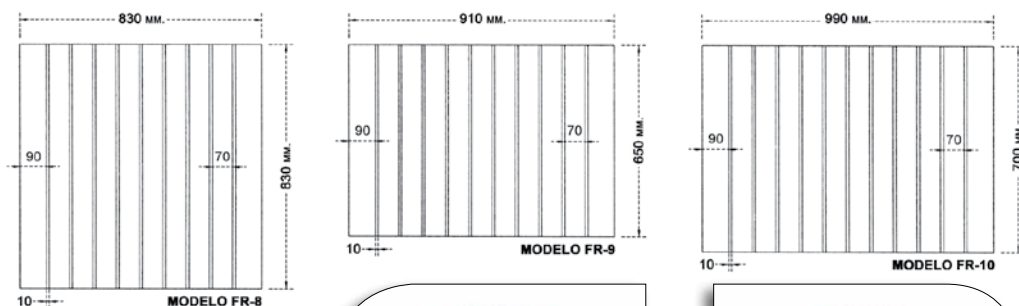
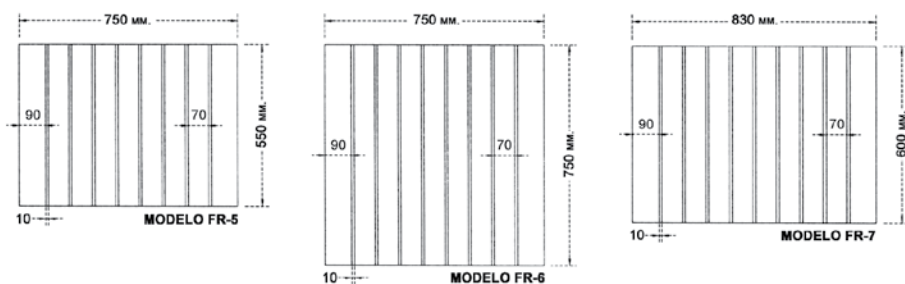
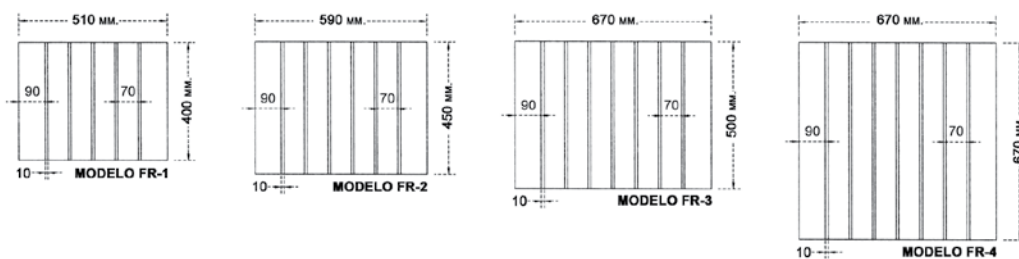

### CARACTERÍSTICAS DE LOS MODELOS STANDARD:

- Chapa de 2 mm. de grosor.
- Fresado decorativo de líneas paralelas de 10 mm. de ancho.
- Distancia entre fresados: 70 mm.
- Distancia entre fresado y exterior: 90 mm.
- Acabados: Lacado, Anodizado o Bruto.

### FABRICACIÓN ESPECIAL:

- De cualquier medida.
- Con fresado de cualquier diseño (líneas, cuadrados, rectángulos, etc...).
- Posibilidad de insertar en el Fresado tiras decorativas en Aluminio Anod. Inox.
- Lacado imitación madera o sándwich.



## PANELES FRESADOS DECORATIVOS DE ALUMINIO



**Viena**  
Ref: PFVI-



**Londres**  
Ref: PFLO-



**Madrid**  
Ref: PFMA-



**París**  
Ref: PFPA-



**Lyon**  
Ref: PFLY-



**Amsterdam**  
Ref: PFAM-



**Roma**  
Ref: PFRO-



**Milán**  
Ref: PFMI-



**Berlín**  
Ref: PFBE-



**Bonn**  
Ref: PFBO-



### CARACTERÍSTICAS DE ESTOS MODELOS:

- Medida standard 2000x800x20 mm.
- Chapa de Aluminio de 2 mm. de grosor.
- Fresado decorativo de 10 mm. de ancho.
- Núcleo Fenólico.
- Acabados: Lacados o Anodizados.

### FABRICACIÓN ESPECIAL:

- De otras medidas (hasta 2500x1200 mm.)
- De fijos de cualquier medida.
- Con Fresado de cualquier diseño (líneas, cuadrados, rectángulos, etc...).
- Posibilidad de insertar en el Fresado tiras decorativas en Aluminio Anod. Inox.
- Posibilidad de superponer superficies decorativas en Aluminio Anod. Inox.
- Lacado imitación madera.
- Con las dos caras en distinto modelo y/o acabado.





## SIN CRISTAL



**San Marcos**  
Ref: PL-



**Báltico**  
Ref: PB-



**Ártico**  
Ref: PA-



**Cantábrico**  
Ref: PCAN-



**Aral**  
Ref: PARA-



**Polar**  
Ref: PPOL-



**Atlántico**  
Ref: PATL-



**Kara**  
Ref: PAK-



**Antártico**  
Ref: PANT-



**Cáspio**  
Ref: PCAS-



**Barents**  
Ref: PBAR-



**Ártico**  
Ref: PAF-



**Bering**  
Ref: PBEF-



**Caspio**  
Ref: PCASF-

## CON CRISTAL



**Catedral**  
Ref: PC-



**Catedral II**  
Ref: PCII-



**Caribe**  
Ref: PR-



**Coral**  
Ref: PCO-



**Mediterráneo**  
Ref: PMED-



**Índico**  
Ref: PIND-



**Jónico**  
Ref: PJON-



**Pacífico**  
Ref: PPAC-



**Tirreno**  
Ref: PTIR-



**Egeo**  
Ref: PEG-



**Adriático**  
Ref: PADR-



**Coral**  
Ref: PCOF-



**Alborán**  
Ref: PALF-

### CARACTERÍSTICAS STANDARD:

- Medidas del panel 2000x800x20 mm. y del fijo 2000x400x20 mm.
- Chapa de Aluminio de 1,5 mm. de grosor.
- Interior de poliestireno de alta densidad.

### FABRICACIÓN ESPECIAL:

- De otras medidas (hasta 2100x900 mm.)
- Lacado imitación madera o foliado.
- Con Núcleo Fenólico, con chapa blindada.
- Con las dos caras en distinto modelo y/o acabado.

## TAPAS DE MEDIA LUNA

### PLÁSTICO



**60x20**  
Ref: TPML62 (Negro)  
Ref: TPML62B (Blanco)

### ALUMINIO



**60x20**  
Ref: TAML62-



**60x40**  
Ref: TAML64-



**60x60**  
Ref: TAML66-

ACABADOS: LACADOS BLANCO, NEGRO Y COLORES



## TAPAS PUNTA DE FLECHA EN PLÁSTICO

**MODELO ESPECIAL**  
PARA CORTE RECTO O CORTE EN INGLETE



**60x20**  
Ref: TPJF62 (Negro)  
Ref: TPJF62B (Blanco)



**80x20**  
Ref: TPF82 (Negro)  
Ref: TPF82B (Blanco)





# ACCESORIOS DE ALUMINIO PARA VERJAS



**INCLINA-VERJAS**  
Ref: INVE-



**FIJA-VERJAS 40x20**  
Ref: FV4020-

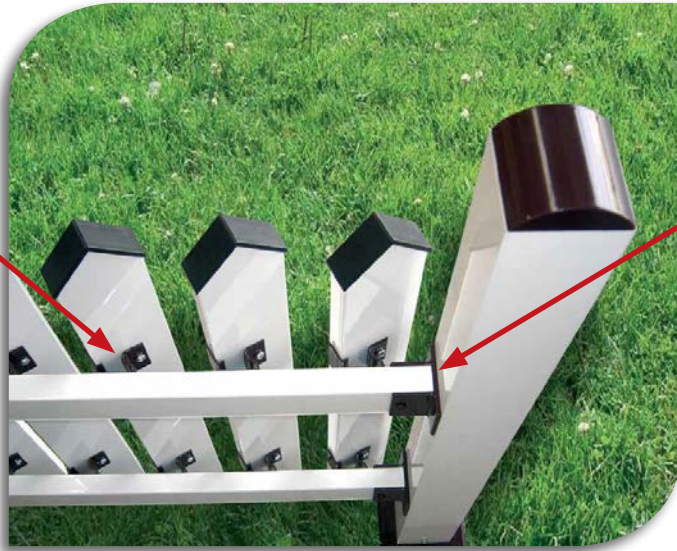

El Inclina-verjas permite la inclinación de cada tubo de la verja, con el fin de crear un efecto visual semejante a la inclinación de una mallorquina.

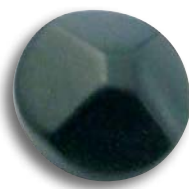
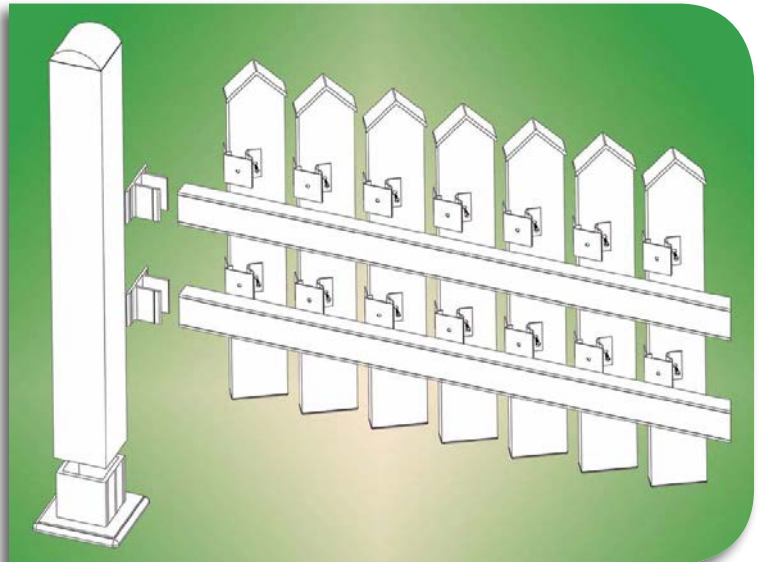
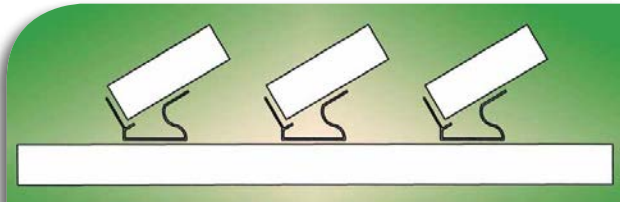
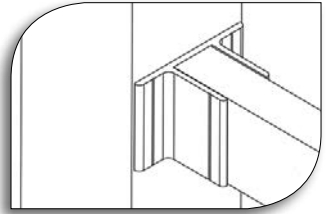

**CLAVO DECORATIVO DE ALUMINIO**  
**Ø27 mm.**  
Ref: CLAR27-





## CHAPA TRENZADA DECORATIVA DE ALUMINIO

Para la realización de Celosías, Balconadas, Barandillas, Cenadores, Separadores de ambientes, Cerramientos, Verjas y un sin fin de trabajos de carpintería.

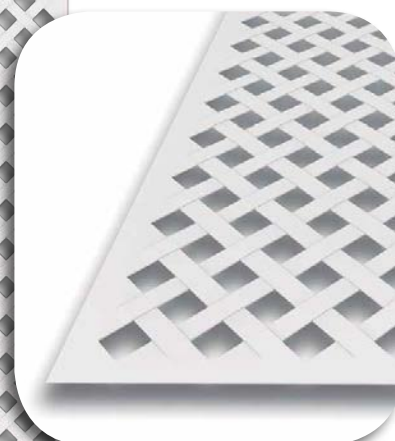
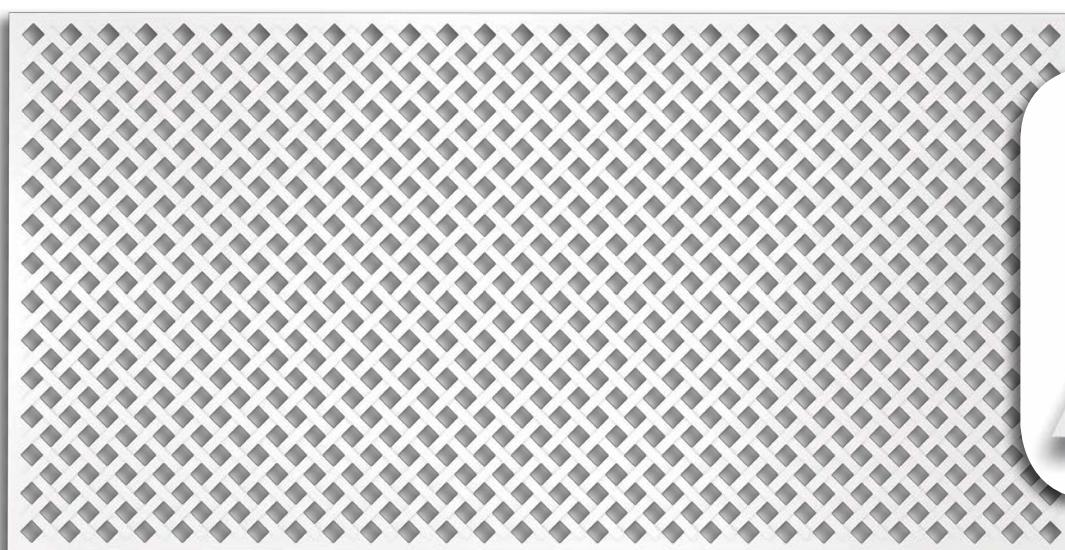

TRENZALUM es una chapa perforada de aluminio que simula un trenzado en diagonal.

De fácil instalación, muy decorativa y duradera.

Medida standard: 2000x1000x2 mm.

La medida del cuadrado es de 30 mm., siendo siempre el nervio de 20 mm.

Posibilidad de suministro en otras medidas.

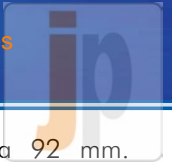

El Escudo Largo se puede suministrar tanto ciego, como con el bocallave tipo pera a 85 mm. o a 92 mm. Se suministra por unidades independientes, ya que se transforma fácilmente a la orientación deseada (Izqda. o Dcha.).



**ESCUDO LARGO**  
**MODELO "KLIMT"**  
Ref: EKLI-



**MANILLA REVERSIBLE**  
**MODELO "PICASSO"**  
Ref: MPI-

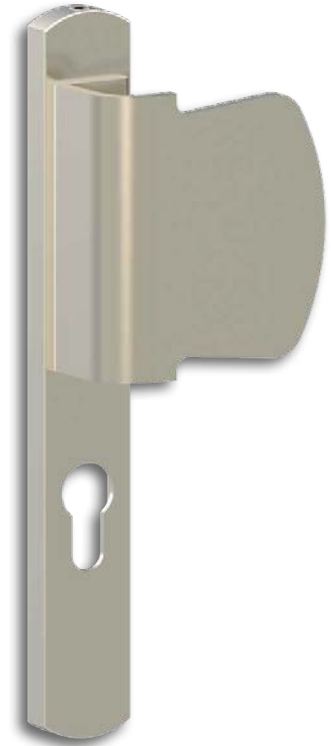

**ASA - TIRADOR**  
**MODELO "DALÍ"**  
Ref: ASADA-

El novedoso sistema de Anclaje del Escudo Largo permite que no se vean los tornillos de fijación. Simplemente se han de colocar en la puerta los dos casquillos suministrados y acoplar el Escudo largo a ellos, fijándolo con sus dos prisioneros correspondientes.



**ASA SIMPLE**  
Ref: ASASI-



**ASA CON PLETINA**  
Ref: ASAPL-

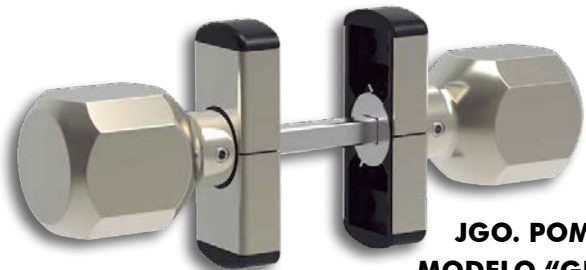

**JGO. POMOS**  
**MODELO "GRECO"**  
Ref: JPGRETO-

Acabados: Lacado Blanco, Negro y Colores y Anodizados Plata, Oro y Acero Inox.

## MULETILLA

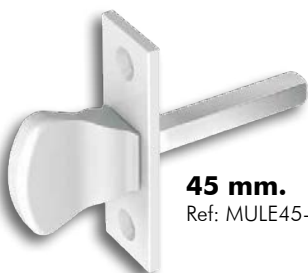

**45 mm.**  
Ref: MULE45-

## PASADOR



**GOTA**  
Ref: PGOTA-



# OJO DE BUEY DE ALUMINIO PARA PUERTAS

www.joaquinplata.es

www.laferreteriaindustrial.es



## Para Puertas de:

- Centros de Enseñanza
- Edificios Públicos
- Salas de Actos
- Restaurantes
- Residencias
- Guarderías
- Despachos
- Gimnasios
- Cocinas
- Cines
- Etc.



Ø300 mm.  
Ref: OBP300-



Consta de 2 aros especiales de aluminio que encajan uno dentro del otro.

La colocación del cristal, de hasta 18 mm. de grosor, se realiza fácilmente fijando el arillo de sujeción con los 4 prisioneros de acero suministrados.

Permite su colocación en puertas o paneles de un grosor de 20 a 45 mm.

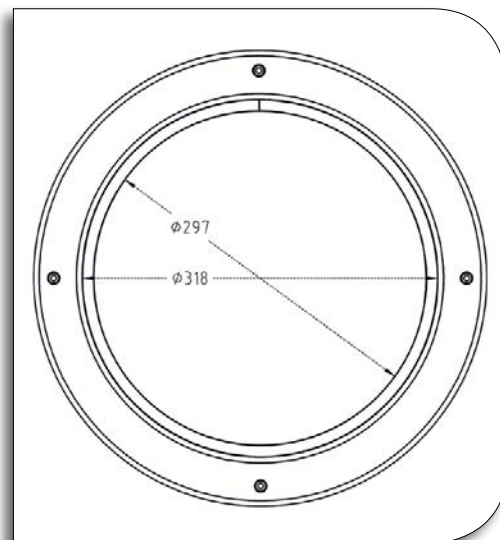
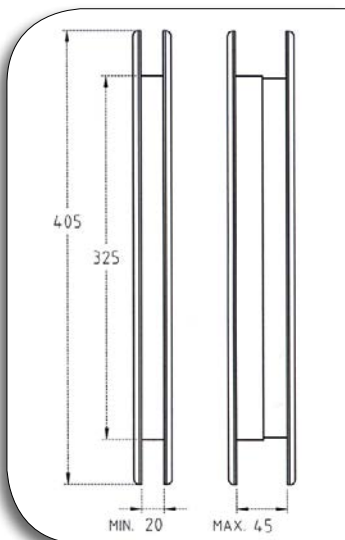

ACABADOS: ANODIZADO INOX., LACADO BLANCO, NEGRO Y COLORES

www.laferreteriaindustrial.es

www.joaquinplata.es



**FIJO**  
Ref: OJAFI\*



**PREMARCO**



**PIVOTANTE**  
Ref: BUEY\*

## FUNDICIÓN DE ALUMINIO MONOBLOQUE



- Medidas:
- Ø 400 mm.
  - Ø 500 mm.
  - Ø 600 mm.
  - Ø 700 mm.
  - Ø 800 mm.
  - Ø 1.000 mm.



- ACABADOS:**
- LACADO BLANCO, NEGRO Y COLORES RAL.
  - POSIBILIDAD DE LACADO IMITACIÓN MADERA



Incluyen Premarco de Poliuretano rígido, que facilita el montaje en la obra.  
Amplia superficie acristalada.  
Permiten colocar un cristal de hasta 19 mm. de grosor.



## PREMARCO

Premarco de Aluminio Curvado, con garras, para un rápido montaje en obra. Es opcional, y se puede colocar con cualquiera de los 4 modelos. Se fabrica en cualquier medida entre Ø50 y Ø130 cm.



## MODELO "GIRALUM" - APERTURA GIRATORIA

Innovador Sistema de Apertura formado por un semicírculo superior fijo y otro inferior móvil, que se desliza por un carril a lo largo de la circunferencia.

La ventana abre progresivamente al girar a izquierda o derecha, pudiendo dejarse abierta en cualquier posición intermedia, no invadiéndose el exterior ni el interior de la vivienda.

Dispone de un mecanismo de bloqueo, ofreciendo un perfecto cierre y estanqueidad.

Se fabrica en cualquier medida entre Ø50 y Ø130 cm., con o sin solape.

Se sirve siempre con cristal, Climalit 4+6+4 u otros.



Cerrado



Apertura Parcial



Apertura Total

## MODELO "INTALUM" - APERTURA INTERIOR

Fabricado mediante perfiles de Rotura de Puente Térmico.

Su sistema de apertura se realiza por medio de una bisagra y compases ocultos, con lo que se consigue una gran superficie acristalada, sin travesaños que reducirían la luz.

Su cierre se realiza mediante golpepe metálico.

Se fabrica en cualquier medida entre Ø70 y Ø130 cm., con o sin solape.

Se sirve sin cristal, con cristal Climalit 4+10+4 o con cristal especial.



## MODELO "FIJALUM" - FIJO

Fabricado con Perfilera Europea Curvada con junquillo redondeado.

Se fabrica en cualquier medida entre Ø50 y Ø130 cm., con o sin solape.

A partir de Ø70 cm., existe la posibilidad de fabricación con Rotura de Puente Térmico.

Se sirve sin cristal, con cristal Climalit 4+6+4 o con cristal especial.





## MODELO "ABATALUM" - APERTURA ABATIBLE

Fabricado con Perfilera Europea Curvada y cierre de golpete, o manilla de presión en medidas grandes.

Abatible a 15° - 30° ó 45°, al llevar incorporado nuestro Juego Compás Basculante.

Se fabrica en cualquier medida entre Ø50 y Ø130 cm., con o sin solape.

A partir de Ø70 cm., existe la posibilidad de fabricación con Rotura de Puente Térmico.

Se sirve sin cristal, con cristal Climalit 4+6+4 o con cristal especial.



## JUEGO COMPÁS BASCULANTE

Permite la regulación de apertura de Ventanas Basculantes, Ojos de Buey y Arcos de medio punto intercalando esta sencilla pieza en el eje de cada bisagra estándar (con pernio de 8 mm.), con lo que le confiere una apertura de **45°**. Posteriormente, en cualquier momento, podemos insertar uno de los dos suplementos suministrados, lo que va a permitir que la apertura sea de **15°** o de **30°**.

### Apertura:

- 15°
- 30°
- 45°



Ref: JCB-3

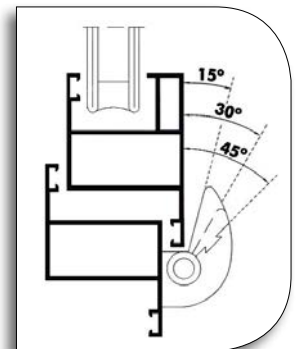

## JUEGO CLIPA-COMPÁS

Permite la regulación de apertura de Ventanas Basculantes, Ojos de Buey y Arcos de medio punto de Series Europeas, simplemente clipando en el canal europeo esta innovadora pieza al lado de cada bisagra, con lo que le confiere una apertura de **170°**. (Opcionalmente se puede atornillar). Posteriormente, en cualquier momento, podemos insertar uno o dos suplementos suministrados, lo que va a permitir que la apertura sea de **20°** o de **45°**.

### Apertura:

- 20°
- 45°
- 170°



Ref: JCLIC-3

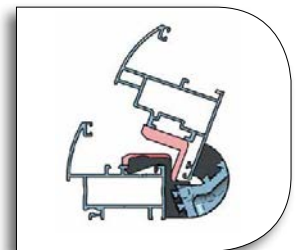

### VENTAJAS DE LOS 2 MODELOS:

- Son los sistemas de apertura basculante más económicos.
- Rápida instalación. Fácil limpieza del cristal.
- El usuario final puede variar fácilmente el ángulo de apertura, con los suplementos incluidos.

Se aconseja su utilización en ventanas menores de:

- h700x1200 (con cristal de 4 o 6 mm.)
- h350x700 (con cristal tipo climalit)
- h450x450 (con cristal tipo climalit)



## CON RETENCIÓN A 90° Y REGULACIÓN DE FUERZA Para Puertas de Aluminio, PVC, Cristal, Madera, Hierro y Acero



Colores: Blanco - Negro - Plata



El sencillo sistema de este cierrapuertas evita los problemas de espacio que ocasiona el brazo articulado de otros cierrapuertas. Fácil Montaje. Incluye Tornillos.

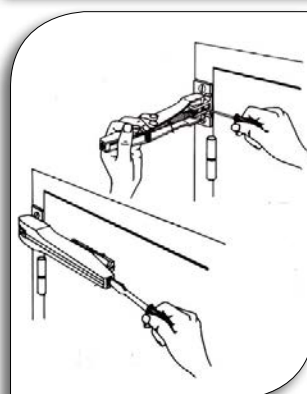
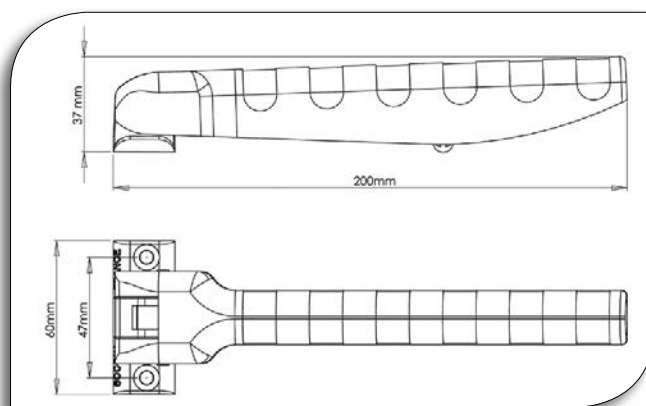

Sirve para suplementar el cierrapuertas únicamente en puertas superpuestas al marco o con algún tipo de resalte.



**ADAPTADOR PARA CIERRAPUERTAS**  
Ref: CPA





## MIRILLA OCULTA EN PLACA DE IDENTIDAD

## MIRILLA NORMAL

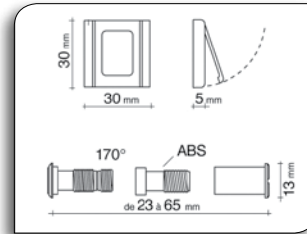

## MIRILLA SISTEMA TODO-ALUM

## MIRILLA EN ACERO INOX.



PARA GROSORES DE PUERTA  
de 11 a 21 mm.      de 21 a 36 mm.      de 27 a 55 mm.

**CORTA**      **MEDIANA**      **LARGA**  
Ref: ALU-MI      Ref: ALU-MIM      Ref: ALU-MIL



PARA GROSORES DE PUERTA  
de 22 a 39 mm.

**COLONIA**  
Ref: MIRCOL

# RETENEDOR DE SEGURIDAD

## PARA PUERTAS DE ENTRADA

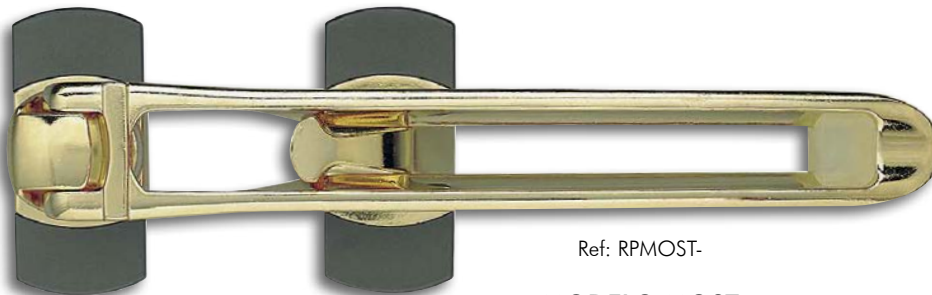

MODELO MOST

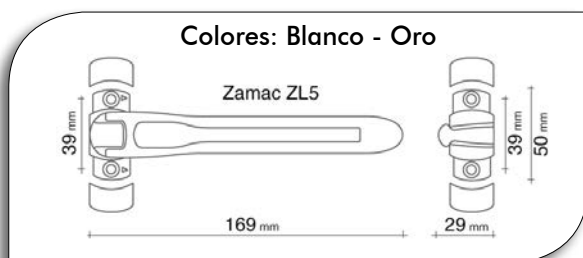



## PARA VENTANAS Y PUERTAS PRACTICABLES DE 1 Ó 2 HOJAS



**CON PULSADOR**

Ref: RTACP-



**CON LLAVE**

Ref: RTACL-

Posibilidad de fabricación de varias unidades con una misma llave.

### MODELO AIRLOCK

Colores: Blanco - Negro - Inox.

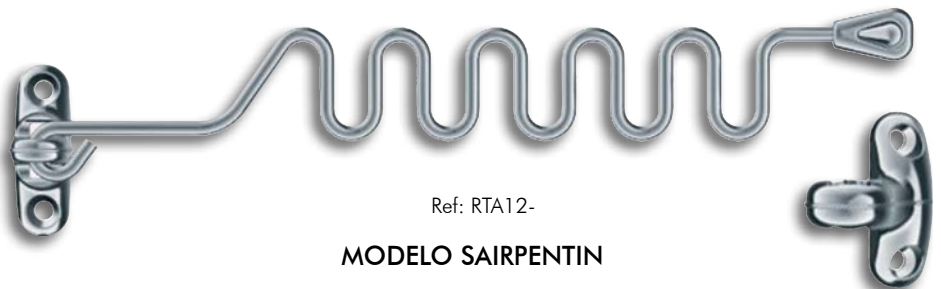
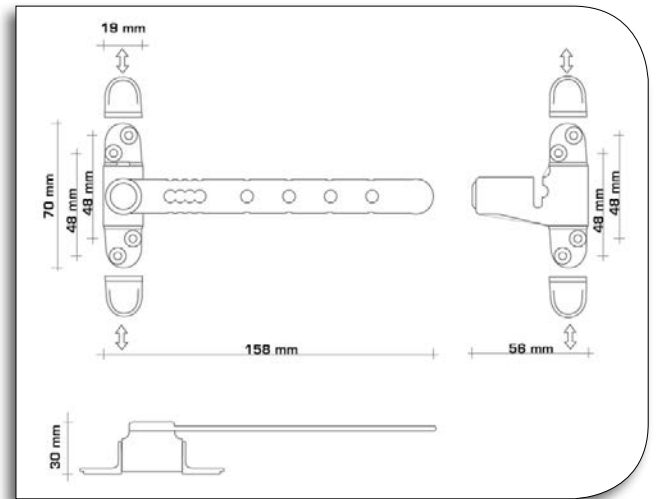

Ref: RTA12-

**MODELO SAIRPENTIN**

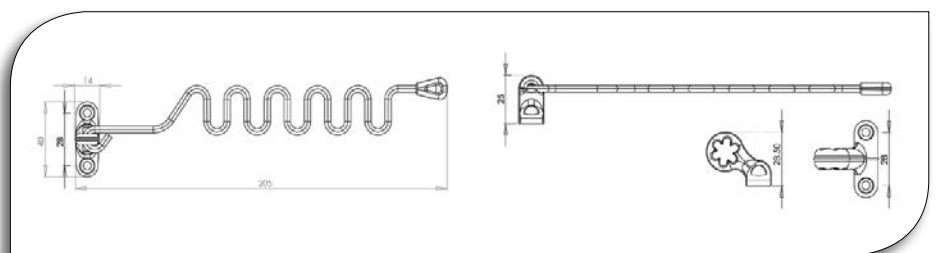

Colores: Blanco - Oro - Cromado - Bronce Oscuro

## PARA VENTANAS Y PUERTAS PRACTICABLES DE 1 Ó 2 HOJAS



Ref: RTPIN-5

### MODELO AIRCLIP

Disponible en Blanco (Plástico)  
Se coloca sin taladrar y sin adhesivo



## PARA VENTANAS Y PUERTAS CORREDERAS



Ref: RT-C

### MODELO AIRBAIE

Colores: Blanco - Negro - Plata

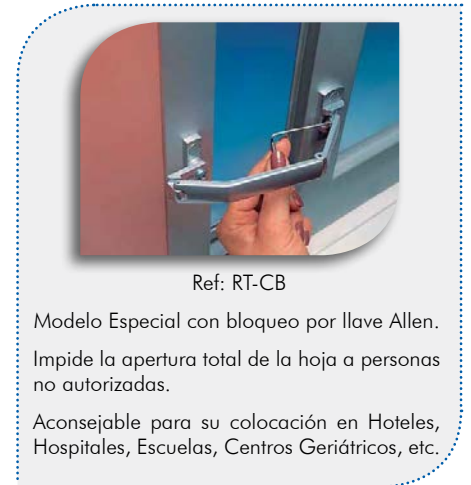

Ref: RT-CB

Modelo Especial con bloqueo por llave Allen.  
Impide la apertura total de la hoja a personas no autorizadas.

Aconsejable para su colocación en Hoteles, Hospitales, Escuelas, Centros Geriátricos, etc.

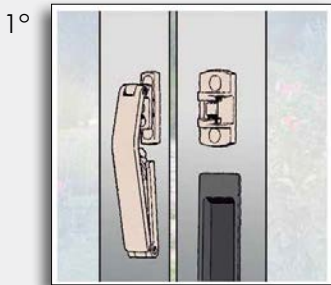

1° Posición descanso

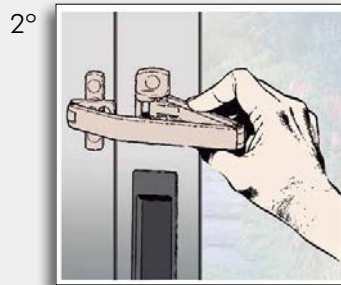

2° Enganchar el retenedor

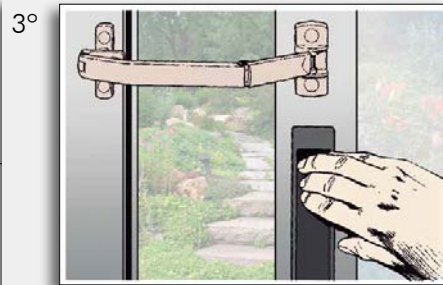

3° Entreatrir la ventana o puerta corredera

Estando abierta, no puede ser desenganchado ni desde el exterior, ni desde el interior.



Evita cualquier intrusión y protege a los niños de peligros exteriores.

Apertura limitada a 110 mm., según normativa vigente.

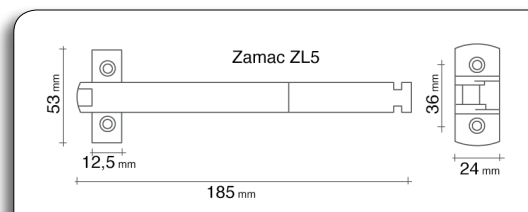





Ref: DORY



## BLOQUEO ANTI-PILLA DEDOS

Al impedir que la puerta se cierre completamente, evita que los niños se pillen los dedos accidentalmente o se queden encerrados en una estancia.

Recomendamos colocar Dory lo más alto posible.



Ref: CLIPY



## CUÑA BLOQUEA-PUERTAS Y ANTI-PILLA DEDOS

Colocada en la puerta, impide que se cierre completamente, evitando que los niños se pillen los dedos o se queden encerrados en una estancia.

Para una máxima protección, coloque Clipy en la parte superior de la puerta.

Colocada en el suelo, retiene la puerta en la posición deseada.



Ref: SOKY

## PROTEGE ESQUINAS

Kit con 4 protecciones transparentes para esquinas.

Evitan los accidentes provocados por golpes contra las esquinas de los muebles.

Resistentes al arranque (adhesivos invisibles incluidos), estéticas y discretas.

Fabricadas en plástico alimentario y sin Bisphenol A, garantizando así la seguridad infantil.

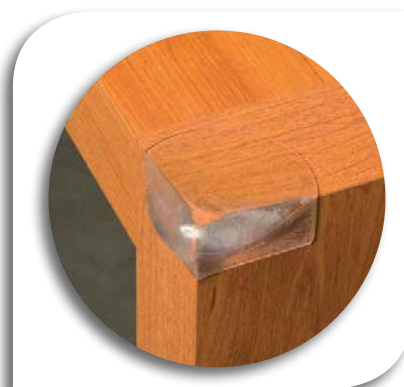



# TOPE PARA PUERTAS Y VENTANAS CORREDERAS

www.joaquinplata.es

www.laferreteriaindustrial.es

Evita que las hojas de las correderas golpeen los accesorios de apertura o cierre. Igualmente puede utilizarse como tope de puertas abatibles y otros usos. Se puede instalar en la parte interior o exterior de las hojas correderas.

Acabados: Lacado Blanco, Negro y Colores



Ref: TOPECO-

Es recomendable la colocación de 2 unidades, una en la parte superior y otra en la parte inferior.



Es posible colocar TOPECO entre las guías.

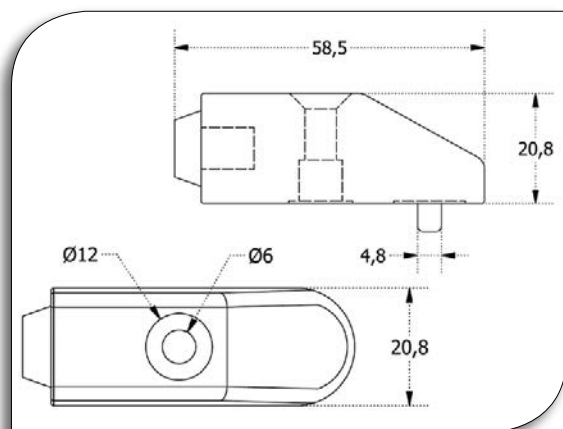

## JUEGOS DE DOBLE CONTACTO

Permiten el paso de corriente a 8-12 V. entre el marco y la hoja de la puerta, evitando el deterioro del cable.



**NORMAL**  
Ref: 55



**ESPECIAL PARA SERIES EUROPEAS**  
Ref: JDCEU

Incluye suplementos de ajuste



## TAPAS INVERSORAS

Disponibles en Blanco y Negro



**40x18**  
Ref: 9999

**40x20**  
Ref: 9998

## EMBELLECEDORES PARA BOMBÍN

Disponibles en Blanco y Negro



**OVALADO**  
Ref: EMBOVA



**CUADRADO**  
Ref: EMBCUA

## ESCUADRAS MOSQUITERA CON RODAMIENTO

**SERIE NORMAL**  
Ref: EMR



**SERIE EUROPEA**  
Ref: EM-ER



**SERIE CORTE RECTO**  
Ref: EMCR-



Disponibles en Negro y Blanco

## CERRADEROS



Ref: 1410



Ref: 1411

## ESCUADRA 8 MM.



Ref: 1400

## PATÍN CENTRAL



Ref: 1405

## VIERTEAGUAS

Disponibles en Blanco y Negro



**DESAGÜE INFERIOR**  
Ref: 1420

← PEQUEÑOS →



**DESAGÜE LATERAL**  
Ref: 1430



**DESAGÜE INFERIOR**  
Ref: 1425

← GRANDES →



**DESAGÜE LATERAL**  
Ref: 1426

## GOLPETE

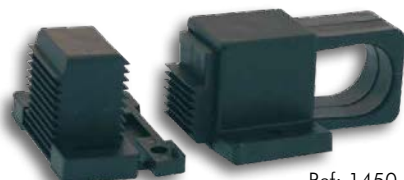

Ref: 1450

## VALVULA DESAGÜE



Ref: 1415

RECTANGULARES		CUADRADAS		REDONDAS		TAPAS FINALES	
REF.	MEDIDA EXT.	REF.	MEDIDA EXT.	REF.	MEDIDA EXT.	REF.	MEDIDA EXT.
2010	<b>20 x 10</b>	1010	<b>10 x 10</b>	9918	<b>Ø18</b>	TFI10	<b>Ø10</b>
2510	<b>25 x 10</b>	1414	<b>14 x 14</b>	9920	<b>Ø20</b>	TFI12	<b>Ø12</b>
3010	<b>30 x 10</b>	1616	<b>16 x 16</b>	9922	<b>Ø22</b>	TFI14	<b>Ø14</b>
4010	<b>40 x 10</b>	1818	<b>18 x 18</b>	9925	<b>Ø25</b>	TFI16	<b>Ø16</b>
5010	<b>50 x 10</b>	2020	<b>20 x 20</b>	9930	<b>Ø30</b>	TFI18	<b>Ø18</b>
2015	<b>20 x 15</b>	2222	<b>22 x 22</b>	9932	<b>Ø32</b>	TFI20	<b>Ø20</b>
2515	<b>25 x 15</b>	2525	<b>25 x 25</b>	9935	<b>Ø35</b>	TFI22	<b>Ø22</b>
3015	<b>30 x 15</b>	3030	<b>30 x 30</b>	9940	<b>Ø40</b>	TFI25	<b>Ø25</b>
3515	<b>35 x 15</b>	3535	<b>35 x 35</b>	9945	<b>Ø45</b>	TFI28	<b>Ø28</b>
4015	<b>40 x 15</b>	4040	<b>40 x 40</b>	9948	<b>Ø48</b>	TFI30	<b>Ø30</b>
5015	<b>50 x 15</b>	4545	<b>45 x 45</b>	9950	<b>Ø50</b>	TFI32	<b>Ø32</b>
3020	<b>30 x 20</b>	5050	<b>50 x 50</b>	9955	<b>Ø55</b>	TFI40	<b>Ø40</b>
3520	<b>35 x 20</b>	6060	<b>60 x 60</b>	9960	<b>Ø60</b>	TFI4040	<b>40 x 40</b>
4020	<b>40 x 20</b>	7070	<b>70 x 70</b>	9970	<b>Ø70</b>	TFI5050	<b>50 x 50</b>
5020	<b>50 x 20</b>	8080	<b>80 x 80</b>	9980	<b>Ø80</b>	TFI6060	<b>60 x 60</b>
6020	<b>60 x 20</b>	9090	<b>90 x 90</b>	9990	<b>Ø90</b>	TFI6020	<b>60 x 20</b>
7020	<b>70 x 20</b>	100100	<b>100 x 100</b>	99100	<b>Ø100</b>	TFI6040	<b>60 x 40</b>
8020	<b>80 x 20</b>	120120	<b>120 x 120</b>	99120	<b>Ø120</b>	TFI8040	<b>80 x 40</b>
10020	<b>100 x 20</b>						
3025	<b>30 x 25</b>						
3525	<b>35 x 25</b>						
4025	<b>40 x 25</b>						
5025	<b>50 x 25</b>						
4030	<b>40 x 30</b>						
5030	<b>50 x 30</b>						
6030	<b>60 x 30</b>						
7030	<b>70 x 30</b>						
8030	<b>80 x 30</b>						
10030	<b>100 x 30</b>						
5040	<b>50 x 40</b>						
6040	<b>60 x 40</b>						
7040	<b>70 x 40</b>						
8040	<b>80 x 40</b>						
9040	<b>90 x 40</b>						
10040	<b>100 x 40</b>						
12040	<b>120 x 40</b>						
7050	<b>70 x 50</b>						
8050	<b>80 x 50</b>						
10050	<b>100 x 50</b>						
15050	<b>150 x 50</b>						
17050	<b>170 x 50</b>						
8060	<b>80 x 60</b>						
10060	<b>100 x 60</b>						
12060	<b>120 x 60</b>						
10080	<b>100 x 80</b>						
12080	<b>120 x 80</b>						
14080	<b>140 x 80</b>						
120100	<b>120 x 100</b>						

Medidas en mm.

Colores: Negro y Blanco

Bajo pedido podemos suministrar Tapas de Plástico Estriadas en otros Colores y Medidas.

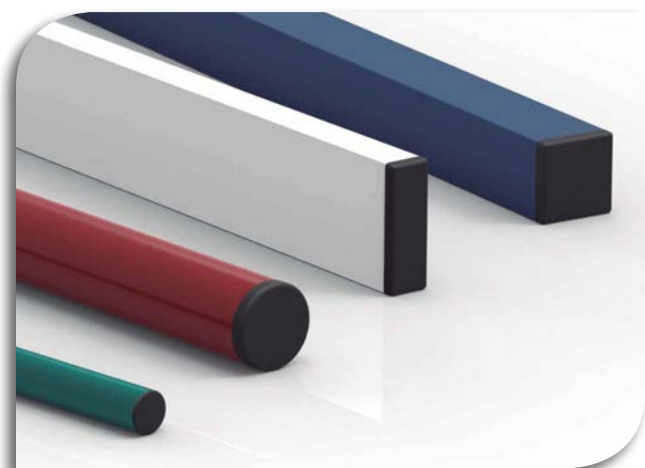

### TAPA CUBRE-CABEZAS DE TORNILLOS

Ref: CUBRE-\*

Admite tornillos de grosor máximo de Ø10 mm. con un máximo de cabeza de ±Ø22 mm.

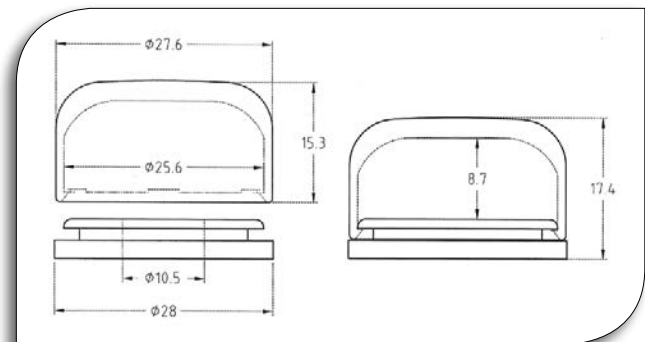

\* Pieza Certificada por CIDEMCO-TECNALIA



## MECANISMOS PARA MALLORQUINAS GRADUABLES

Sirven para la realización de Mallorquinas de Lamas Graduables tipo Perla de 70-71 mm.

Características:

- El diseño del perfil de aluminio y de los portalamas realizados en plástico de gran calidad ofrecen un acabado estético y muy robusto.
- El mecanismo interno que permite la movilidad de los portalamas resulta totalmente fiable y preciso en innumerables aperturas.
- Dispone de un portalamas especial para la media lama terminal de los extremos, anclado en el perfil del mecanismo, que elimina el uso de remaches, tornillos o pegamentos para su fijación.
- Para cámara de 36 mm.
- Distancia standard entre portalamas 60 mm.
- Colores: Negro y Blanco



Ref: MA71RE-

## MANDO DE PALANCA

Permite la regulación de las lamas de las Mallorquinas graduables, cuya apertura se puede fijar en 5 posiciones diferentes.



Ref: PALA71 D (Derecho)  
Ref: PALA71 I (Izquierdo)  
Color Negro



## MANDO ROTATORIO DE MANIVELA

Se clipa en la parte interior del mecanismo de mallorquina. Puede ser colocado a la altura de cualquiera de los portalamas. (No son necesarios fresados)



Ref: MANI71-3 (Negro)  
Ref: MANI71-5 (Blanco)



## TACO DE MEDIO PUNTO

Sirve para realizar de una forma sencilla mallorquinas de medio punto graduables, en combinación con nuestros mecanismos y con el perfil de lama especial.

Ref: TMPD- (Derecho)  
Ref: TMPI- (Izquierdo)

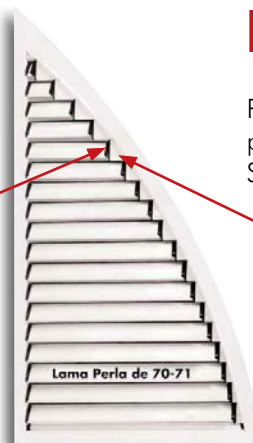

## PERFIL DE LAMA ESPECIAL

Permite realizar de una manera sencilla los pequeños tramos que encajan en la curva. Suministrado en barras de 1 metro.



Ref: LAESMP-

Colores: Negro y Blanco

Acabados: Bruto, Blanco, Colores

## RETENEDOR IMÁN

Sus imanes de gran potencia permiten mantener abiertas Mallorquinas, ventanas, contraventanas o puertas sujetas a la pared. Económico, fácil y rápido de instalar. El kit contiene tacos, tornillos y suplementos.



Ref: IREGP-3  
Color Negro



## GRILLOS 1 HOJA



Ref: GR11H-5 (Blanco)



Ref: GR11H-3S (Negro)

## GRILLO 2 HOJAS



Ref: GR12H-3N (Negro)  
Ref: GR12H-5N (Blanco)

## RETEMALLOR - RETENEDOR DE AYUDA

Su estudiado diseño facilita la apertura y el cierre de las Mallorquinas, especialmente de las que tienen un difícil acceso por la anchura del alféizar u otros, ya que no es necesario asomarse peligrosamente, aumentando así la seguridad y la comodidad. Permite su sujeción hasta 180°, y se puede retener en otra posición intermedia (70° - 90°). Fácil de instalar, incluso en pisos altos, ya que su fijación se hace directamente sobre la carpintería (Aluminio, Madera, PVC), no modificando la estética exterior del edificio.

Realizado en Acero Inox. Color Negro.



Ref: RETE200 (Para hojas menores de 450 mm.)  
Ref: RETE300 (Para hojas mayores de 450 mm.)

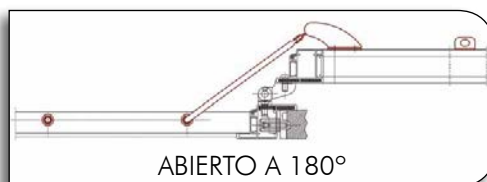
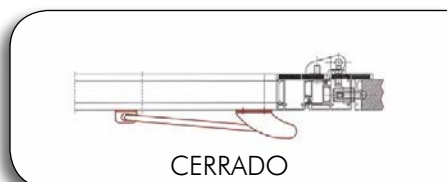



## PARA MALLORQUINA FIJA CON LAMA OVALINA DE 50 MM.

### JUEGO DE TACOS PARA OVALINA DE 50 MM., EN PERFILES DE SERIE 6000 Y CORREDERA



Ref: TACO-M3 (Negro)  
Ref: TACO-M5 (Blanco)

Sirve para perfiles de la Serie 6000 o similares con hueco de 9 a 10 mm. y perfiles de Corredera de un ancho mínimo de 24 mm., para que puedan cruzarse las hojas.

Su estudiado diseño permite que nos ahorremos, con respecto a tacos similares, 2 Lamas y sus correspondientes 4 Tacos por cada hoja y metro de Mallorquina que fabriquemos, dándole además una mayor vistosidad al quedar la lama unas décimas más vertical.

### JUEGO DE TACOS PARA OVALINA DE 50 MM. PARA "U" CON HUECO DE 12 MM.



Ref: TACO12-3 (Negro)  
Ref: TACO12-5 (Blanco)

Sirve para el perfil en U que se clipa en el perfil de 40 mm. o perfiles similares con hueco de 12 mm.

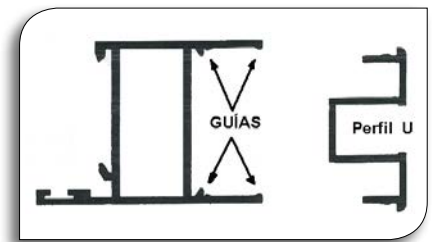

### TACOS Y JUEGOS REMATE PARA OVALINA DE 50 MM. CON PERFIL DE 40 MM.

Su diseño permite que nos ahorremos, respecto al sistema anterior, mucha mano de obra por mallorquina realizada, así como el coste de eliminar el Perfil en U (Figura 1) y el Taco (Figura 2), resultando este sistema muchísimo más rápido, estético y económico. Otra ventaja reside en que el corte de la lama queda oculto en el interior de los tacos, ofreciendo robustez a la mallorquina, evitando vibraciones de las lamas por el viento y eliminando en gran medida la oxidación filiforme de los cortes del perfil en zonas de costa.

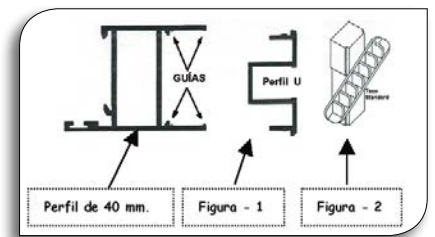

### TACO REVERSIBLE Y JUEGO DE REMATE

Al ser Reversible, agiliza y economiza aún más el montaje. Su especial diseño de 41 mm. de altura, frente a los 38'5 del modelo inferior, permite el ahorro de 4 tacos y 2 lamas por hoja y metro de altura. El Juego de Remate dispone de un canal para la media lama y guarda mano.

### TACO REVERSIBLE

Ref: TAOV50-3 (Negro)



### JUEGO REMATE

Ref: REOV50-3 (Negro)



### JUEGO DE TACO Y JUEGO DE REMATE

#### JUEGO TACO

Ref: TACO-TE3 (Negro)

Los Tacos y Remates se colocan directamente sobre las guías del Perfil de 40 mm.



#### JUEGO REMATE

Ref: TACO-RE3 (Negro)









[www.alumabe.es](http://www.alumabe.es)

[alumabe@alumabe.es](mailto:alumabe@alumabe.es)

Tel. +34 987 262 623

Fax +34 987 262 444

DISTRIBUIDO POR: